

<p>60 Shots</p> 	<p>1: 10.3x ↘ 2: 10.7x ← 3: 10.4x → 4: 10.2x ↖ 5: 10.1 ← 6: 9.5 ↘ 7: 10.5x ↗ 8: 10.4x → 9: 9.6 → 10: 10.1 ↙</p> <p>Series 101.8 101.8</p>	<p>60 Shots</p>  <p>11: 10.2x ↖ 12: 10.0 ↖ 13: 10.4x ↗ 14: 10.0 ← 15: 10.3x ↗ 16: 9.9 ← 17: 10.3x ↗ 18: 10.1 ↖ 19: 10.4x ↘ 20: 10.2x ↘</p> <p>Series 101.8 203.6</p>
<p>60 Shots</p> 	<p>21: 10.4x ↘ 22: 10.5x ↘ 23: 10.1 ↗ 24: 10.6x ↗ 25: 9.7 → 26: 10.3x → 27: 10.7x → 28: 9.9 → 29: 10.0 → 30: 10.7x ↗</p> <p>Series 102.9 306.5</p>	<p>60 Shots</p>  <p>31: 10.5x ← 32: 10.1 ← 33: 9.8 ↖ 34: 10.4x ↘ 35: 9.6 → 36: 10.5x → 37: 10.2x → 38: 10.5x ↗ 39: 10.6x ↘ 40: 10.3x ↘</p> <p>Series 102.5 409.0</p>
<p>60 Shots</p> 	<p>41: 10.2x ← 42: 10.1 ↘ 43: 10.8x → 44: 9.8 ↘ 45: 10.0 ↘ 46: 9.9 ↘ 47: 10.3x → 48: 10.0 ↘ 49: 10.5x ↘ 50: 10.0 ↘</p> <p>Series 101.6 510.6</p>	<p>60 Shots</p>  <p>51: 10.8x ↗ 52: 10.4x ↘ 53: 10.1 ↗ 54: 10.3x → 55: 10.6x ↖ 56: 10.4x ← 57: 10.2x ← 58: 9.5 → 59: 10.2x ↘ 60: 10.7x →</p> <p>Series 103.2 613.8</p>

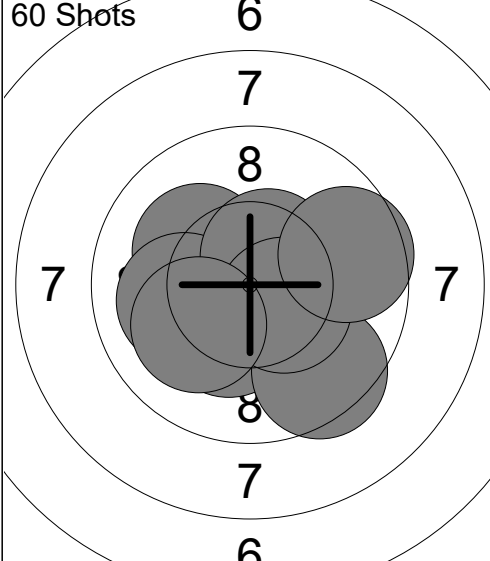

1:	8.3	↗
2:	9.1	↘
3:	10.4x	↗
4:	10.2x	↗
5:	10.4x	↘
6:	9.2	↗
7:	9.9	↗
8:	8.5	↗
9:	9.8	↘
10:	8.7	→
Series		94.5
		94.5

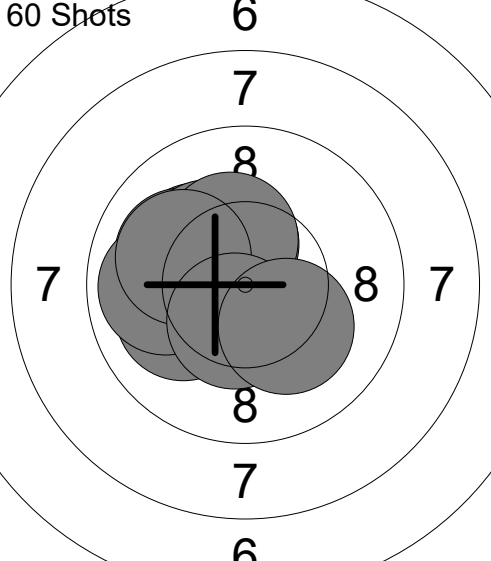
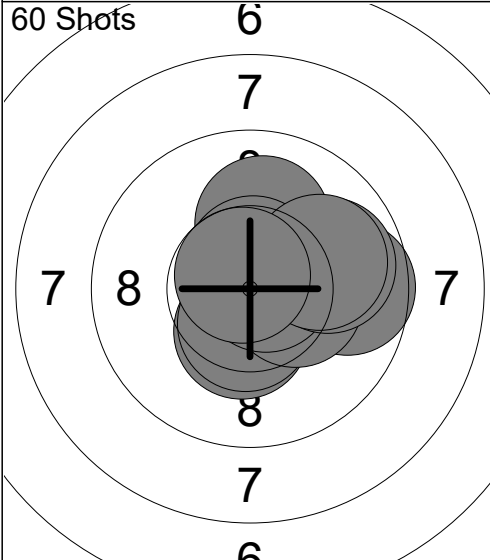
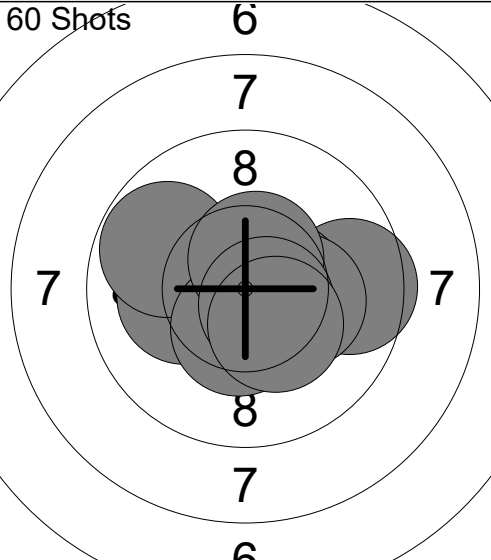
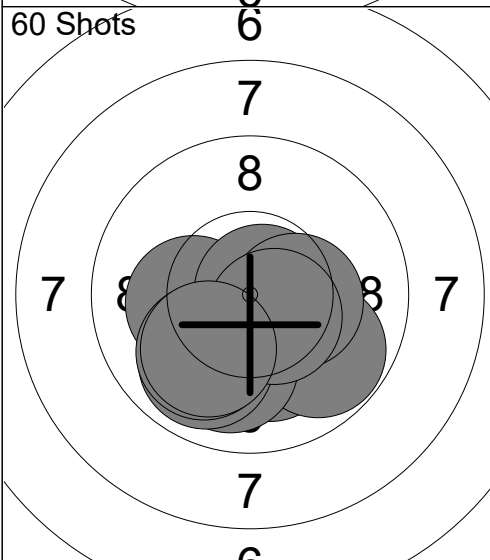
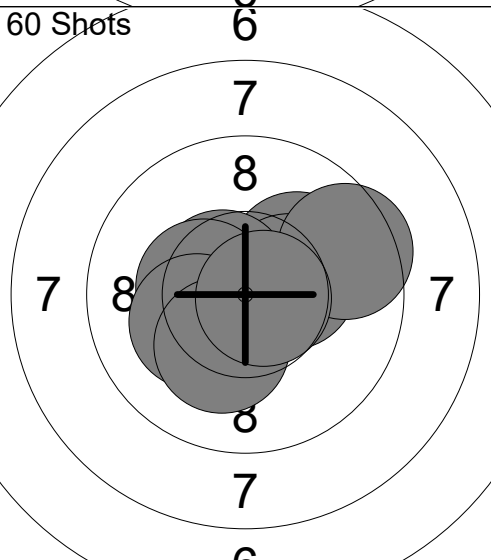
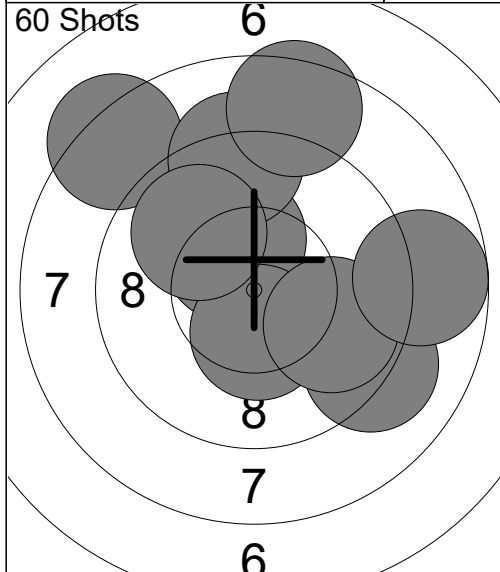
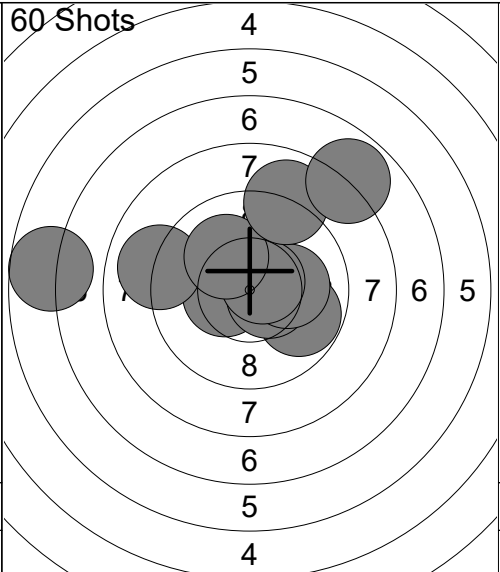

11:	9.8	↘
12:	10.4x	←
13:	6.7	←
14:	10.5x	↘
15:	10.1	→
16:	10.6x	↗
17:	9.0	←
18:	10.1	↗
19:	8.9	↗
20:	7.9	↗
Series		94.0
		188.5

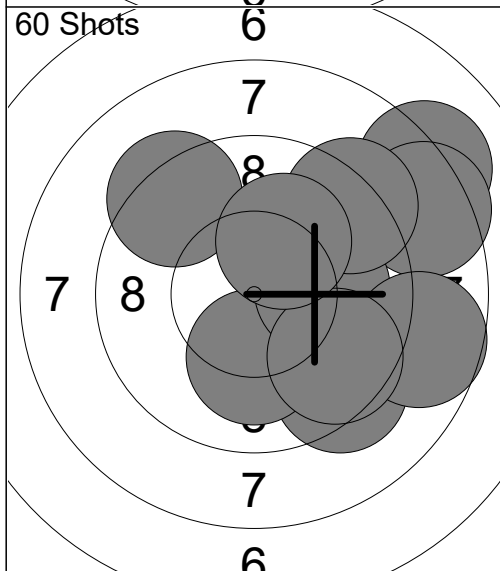

21:	8.2	↗
22:	9.3	↘
23:	10.1	↘
24:	9.3	↗
25:	8.4	↗
26:	10.0	→
27:	8.7	→
28:	9.6	↘
29:	9.2	↗
30:	10.1	↗
Series		92.9
		281.4

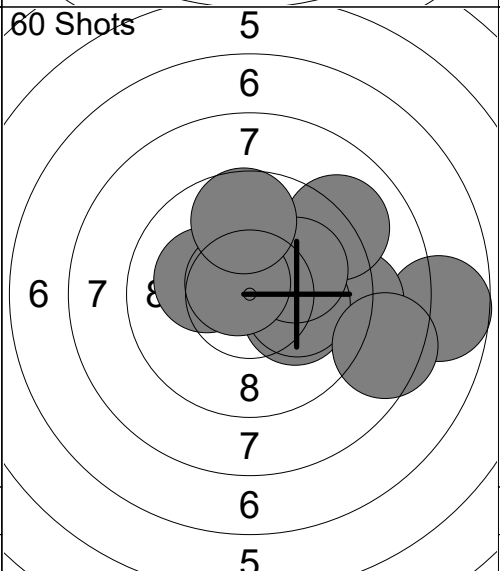

31:	7.7	→
32:	9.2	→
33:	10.2x	←
34:	9.1	↗
35:	10.1	↘
36:	10.1	→
37:	10.1	↗
38:	10.7x	↗
39:	9.7	↗
40:	8.5	↘
Series		95.4
		376.8

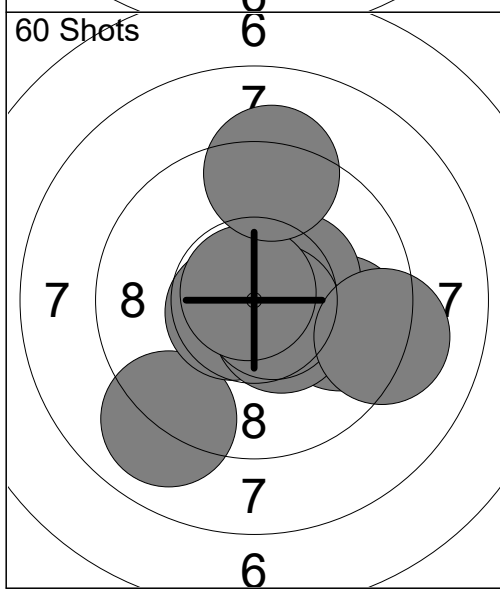

41:	9.0	↘
42:	9.8	→
43:	10.5x	↘
44:	10.4x	↗
45:	10.6x	←
46:	10.5x	↘
47:	10.7x	↘
48:	10.8x	↗
49:	9.2	↗
50:	9.2	→
Series		100.7
		477.5

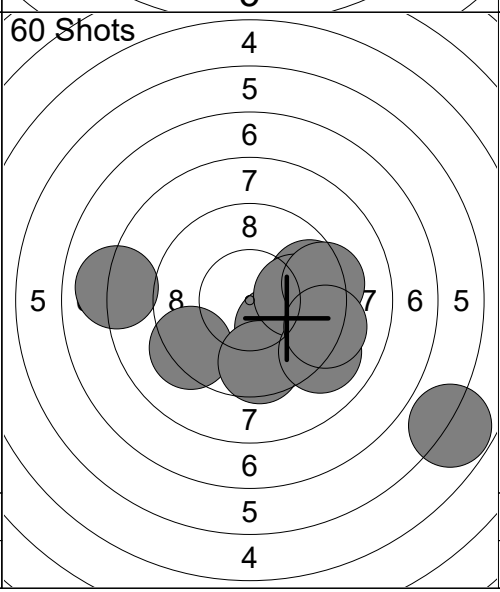

51:	10.1	↘
52:	9.6	→
53:	5.8	↘
54:	9.3	↖
55:	9.6	↘
56:	10.0	→
57:	9.3	→
58:	9.1	↘
59:	8.0	←
60:	9.2	↘
Series		90.0
		567.5

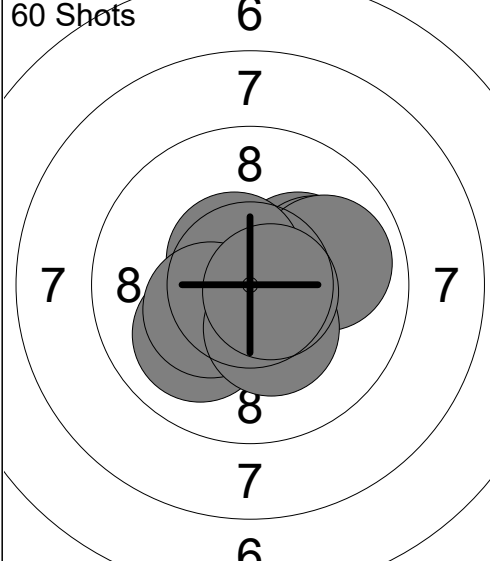
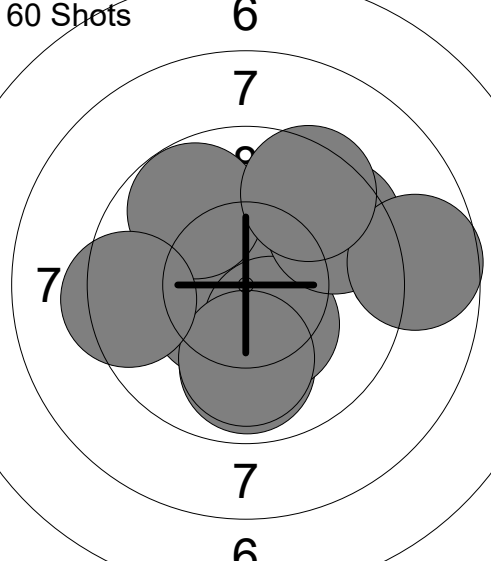
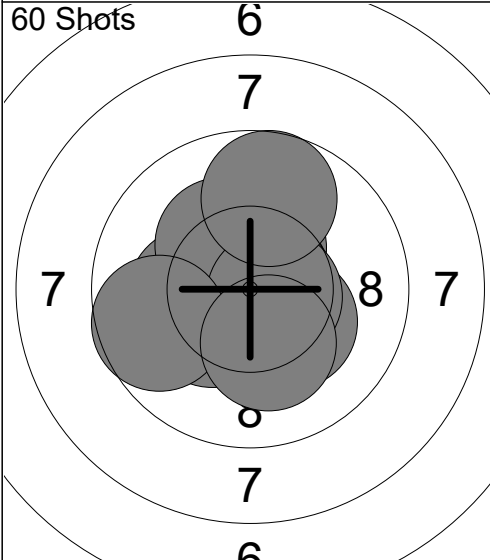
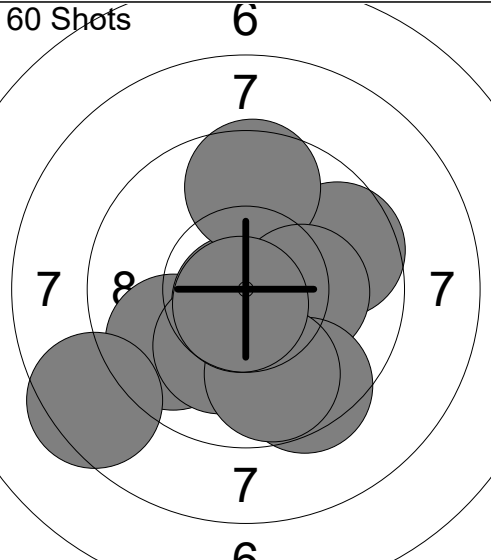
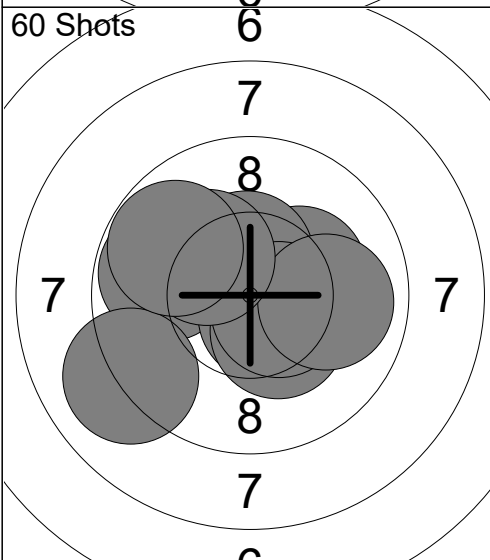
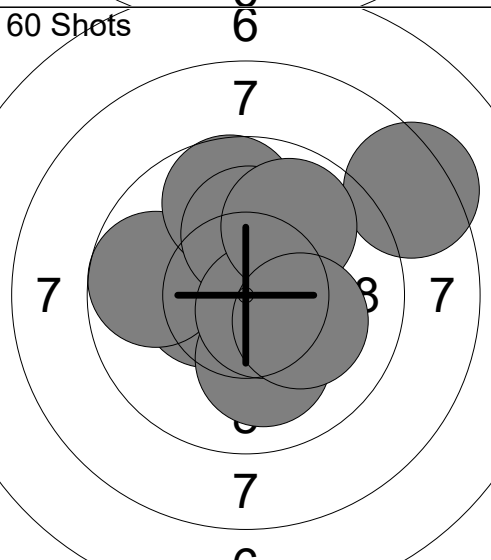
<p>60 Shots</p> 	<p>1: 10.2x →</p> <p>2: 10.5x ↓</p> <p>3: 10.8x →</p> <p>4: 10.0 ↓</p> <p>5: 10.0 →</p> <p>6: 9.9 →</p> <p>7: 10.6x ↗</p> <p>8: 10.3x ↙</p> <p>9: 10.3x ↓</p> <p>10: 10.7x →</p> <hr/> <p>Series 103.3</p> <p style="text-align: center;">103.3</p>	<p>60 Shots</p> 	<p>11: 10.5x ↙</p> <p>12: 9.9 ↓</p> <p>13: 10.7x ↓</p> <p>14: 10.3x ↘</p> <p>15: 9.5 ↗</p> <p>16: 9.8 ↖</p> <p>17: 8.7 →</p> <p>18: 9.5 ↗</p> <p>19: 10.0 ↓</p> <p>20: 9.4 ←</p> <hr/> <p>Series 98.3</p> <p style="text-align: center;">201.6</p>
<p>60 Shots</p> 	<p>21: 10.3x ↙</p> <p>22: 10.3x ↘</p> <p>23: 10.2x ←</p> <p>24: 10.4x ↑</p> <p>25: 10.7x ↗</p> <p>26: 10.3x ↗</p> <p>27: 10.6x →</p> <p>28: 9.7 ↑</p> <p>29: 9.7 ←</p> <p>30: 10.2x ↓</p> <hr/> <p>Series 102.4</p> <p style="text-align: center;">304.0</p>	<p>60 Shots</p> 	<p>31: 9.8 ↙</p> <p>32: 10.8x ↘</p> <p>33: 10.1 ↓</p> <p>34: 8.5 ↙</p> <p>35: 9.6 →</p> <p>36: 9.6 ↑</p> <p>37: 10.2x →</p> <p>38: 9.5 ↓</p> <p>39: 9.8 ↓</p> <p>40: 10.7x ↓</p> <hr/> <p>Series 98.6</p> <p style="text-align: center;">402.6</p>
<p>60 Shots</p> 	<p>41: 9.8 ←</p> <p>42: 10.2x →</p> <p>43: 10.6x ↘</p> <p>44: 10.3x ↘</p> <p>45: 10.5x ↑</p> <p>46: 9.0 ↙</p> <p>47: 10.5x →</p> <p>48: 9.9 →</p> <p>49: 10.2x ↗</p> <p>50: 9.8 ↖</p> <hr/> <p>Series 100.8</p> <p style="text-align: center;">503.4</p>	<p>60 Shots</p> 	<p>51: 10.4x ↑</p> <p>52: 10.5x ←</p> <p>53: 9.7 ←</p> <p>54: 9.7 ↑</p> <p>55: 10.1 ↓</p> <p>56: 8.3 ↗</p> <p>57: 10.1 ↑</p> <p>58: 10.6x ↘</p> <p>59: 9.9 ↗</p> <p>60: 10.2x →</p> <hr/> <p>Series 99.5</p> <p style="text-align: center;">602.9</p>

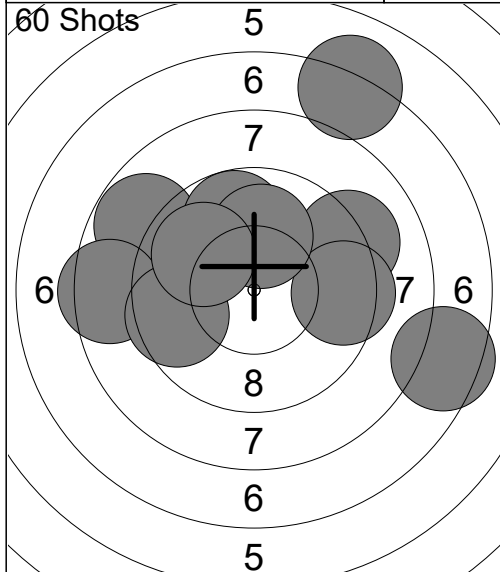

1:	8.8	↖
2:	7.1	↗
3:	9.1	↘
4:	8.5	↙
5:	9.4	→
6:	9.7	↗
7:	10.0	↗
8:	9.5	↙
9:	9.9	↗
10:	7.5	→
Series	89.5	
	89.5	

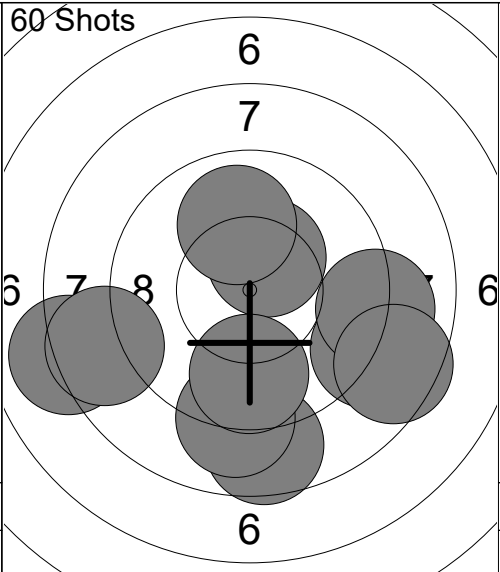

11:	8.9	↘
12:	8.6	↓
13:	9.0	↓
14:	9.0	→
15:	8.5	↘
16:	10.4x	↗
17:	9.7	↓
18:	8.1	↙
19:	8.6	↙
20:	10.0	↗
Series	90.8	
	180.3	

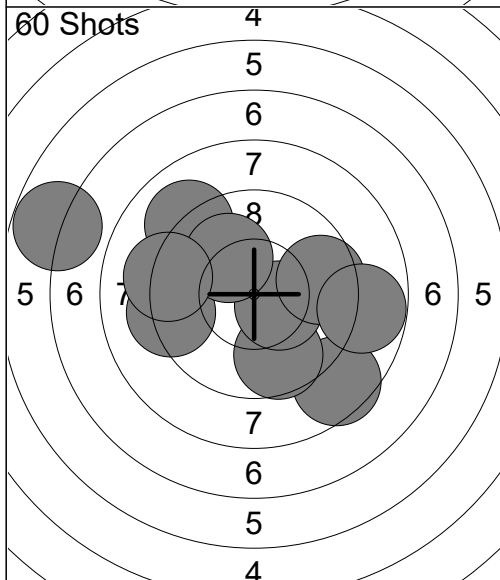

21:	8.5	↓
22:	9.6	↓
23:	10.4x	→
24:	9.0	↗
25:	6.8	↖
26:	9.2	↙
27:	9.6	→
28:	8.8	→
29:	10.1	↗
30:	9.2	↙
Series	91.2	
	271.5	

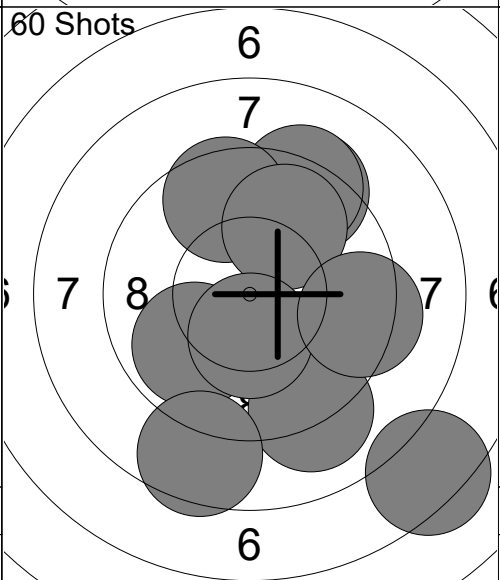

31:	9.3	↗
32:	9.1	↓
33:	9.9	↙
34:	9.3	↗
35:	9.6	↗
36:	9.9	↗
37:	7.3	↘
38:	10.4x	↓
39:	8.6	↓
40:	9.3	→
Series	92.7	
	364.2	

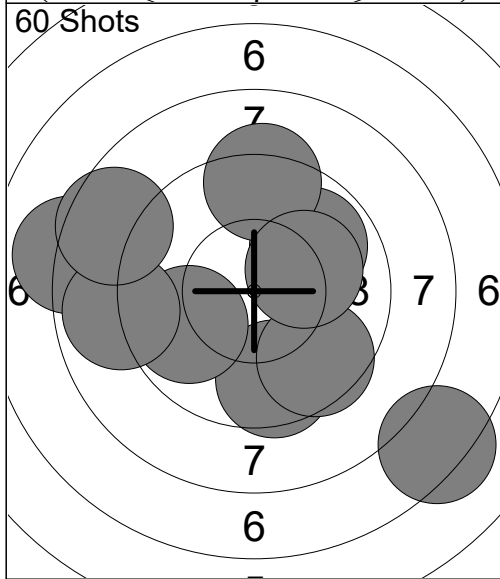

41:	8.1	↙
42:	9.6	↓
43:	7.3	↘
44:	9.8	↙
45:	8.9	↙
46:	8.6	↖
47:	9.6	↓
48:	9.9	↗
49:	9.3	↗
50:	10.1	↘
Series	91.2	
	455.4	

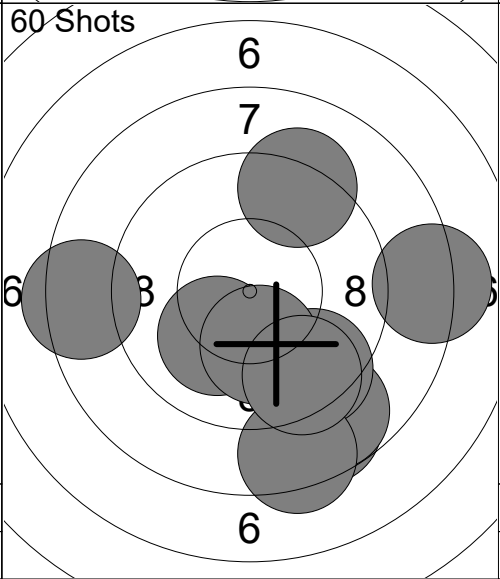

51:	8.6	↓
52:	8.2	→
53:	9.2	↗
54:	10.1	↙
55:	8.8	↓
56:	9.4	↘
57:	8.4	↘
58:	10.1	↓
59:	9.5	↓
60:	8.4	↙
Series	90.7	
	546.1	

<p>60 Shots</p>	<p>1: 10.1 → 2: 9.1 ← 3: 10.2x → 4: 10.2x ← 5: 9.9 → 6: 10.1 → 7: 10.0 ↑ 8: 9.4 ← 9: 10.4x ← 10: 10.3x ←</p> <p>Series 99.7</p>	<p>60 Shots</p>	<p>11: 10.0 ↓ 12: 10.8x ↑ 13: 9.9 ← 14: 9.4 ← 15: 9.3 ← 16: 10.2x ← 17: 10.8x ↗ 18: 8.7 ← 19: 9.6 ↗ 20: 10.2x ↖</p> <p>Series 98.9</p>
	99.7		198.6
<p>60 Shots</p>	<p>21: 9.9 ↖ 22: 9.6 ← 23: 10.0 ↑ 24: 9.0 ↗ 25: 10.2x ← 26: 10.4x ← 27: 9.7 → 28: 9.4 ↗ 29: 9.7 ↗ 30: 9.9 ↖</p> <p>Series 97.8</p>	<p>60 Shots</p>	<p>31: 10.9x ↗ 32: 9.7 ↗ 33: 10.2x → 34: 10.1 ↗ 35: 10.5x ↗ 36: 10.2x → 37: 10.6x ← 38: 10.0 ↓ 39: 10.3x ↗ 40: 10.1 ←</p> <p>Series 102.6</p>
	296.4		399.0
<p>60 Shots</p>	<p>41: 8.6 → 42: 10.3x ← 43: 10.1 ↖ 44: 10.3x ← 45: 10.7x ↗ 46: 10.5x ↑ 47: 10.1 ← 48: 10.0 ↓ 49: 10.3x ← 50: 10.0 ←</p> <p>Series 100.9</p>	<p>60 Shots</p>	<p>51: 9.9 ← 52: 10.5x → 53: 10.2x → 54: 10.6x → 55: 10.3x ↗ 56: 10.3x ↘ 57: 10.4x ↗ 58: 10.1 ↑ 59: 10.2x ← 60: 10.3x ↘</p> <p>Series 102.8</p>
	499.9		602.7

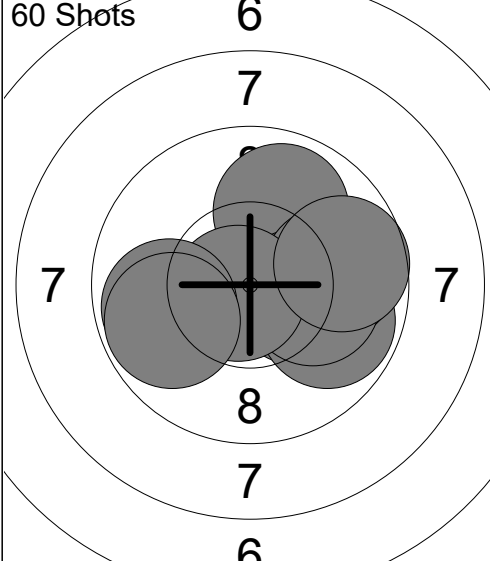
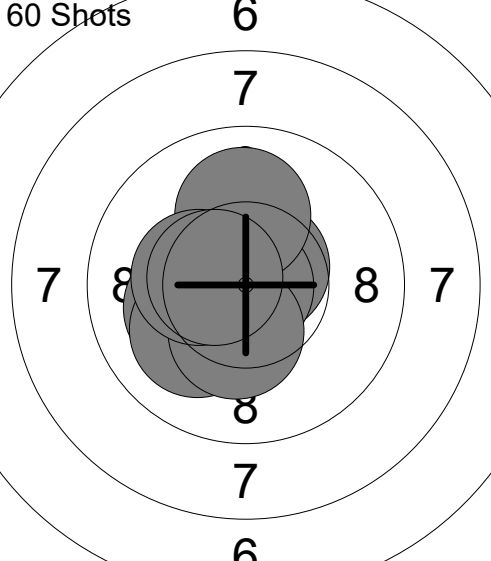
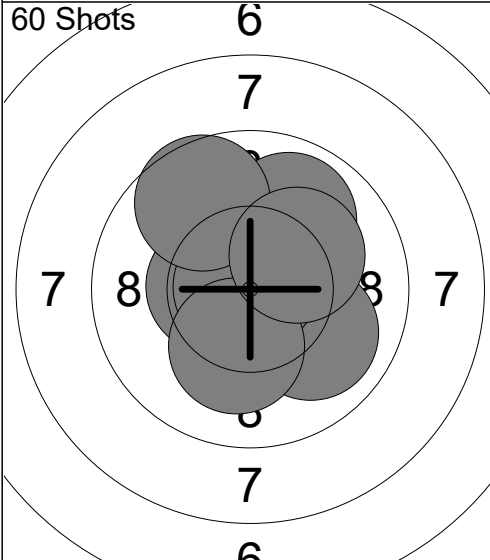
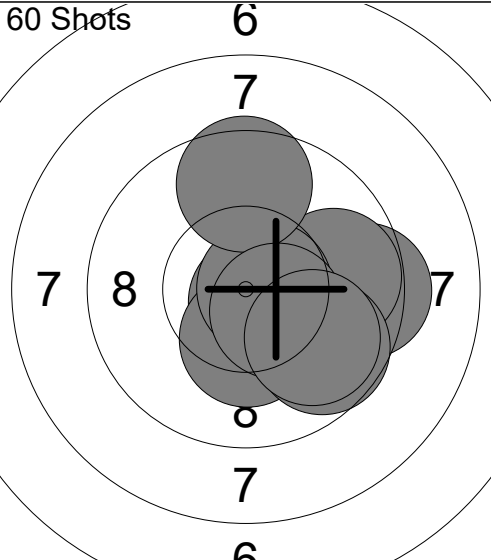
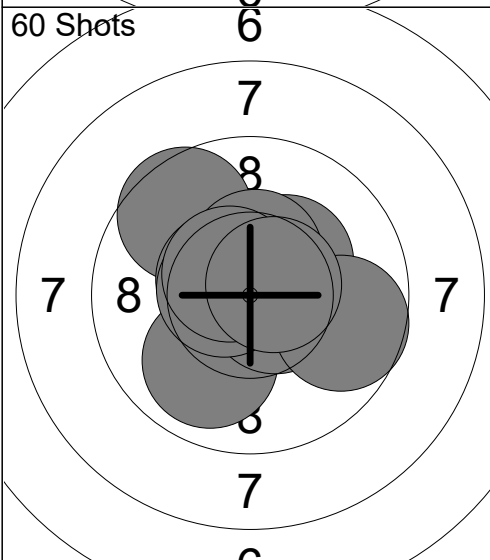
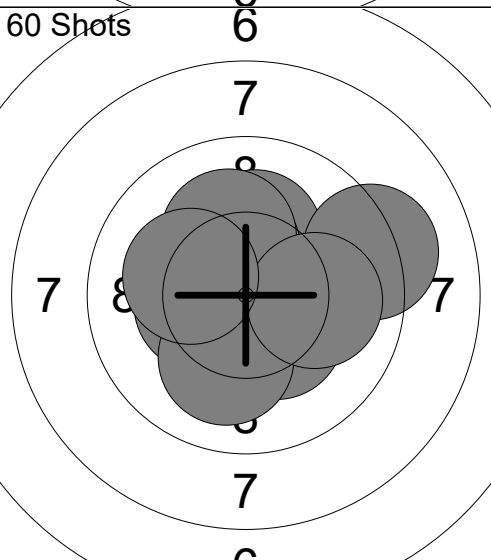
<p>60 Shots</p> 	<p>1: 10.3x ↗ 2: 9.9 ↑ 3: 10.3x → 4: 9.8 → 5: 9.9 → 6: 10.1 → 7: 10.7x ↙ 8: 9.8 ← 9: 9.8 ← 10: 9.7 →</p> <p>Series 100.3 100.3</p>	<p>60 Shots</p> 	<p>11: 10.2x ↙ 12: 10.7x ↗ 13: 10.5x ↙ 14: 10.1 ↙ 15: 10.6x ↗ 16: 10.9x ↓ 17: 10.3x ↓ 18: 10.0 ↑ 19: 10.3x ↙ 20: 10.5x ↙</p> <p>Series 104.1 204.4</p>
<p>60 Shots</p> 	<p>21: 10.0 ↘ 22: 10.3x ↗ 23: 10.8x ↑ 24: 10.5x ← 25: 10.2x ↑ 26: 9.9 ↑ 27: 10.8x ↙ 28: 9.6 ↗ 29: 10.2x ↓ 30: 10.2x ↗</p> <p>Series 102.5 306.9</p>	<p>60 Shots</p> 	<p>31: 10.5x → 32: 9.4 → 33: 9.8 → 34: 10.7x ↘ 35: 10.3x ↓ 36: 10.7x → 37: 9.6 ↑ 38: 10.4x ↘ 39: 9.7 ↘ 40: 9.9 ↘</p> <p>Series 101.0 407.9</p>
<p>60 Shots</p> 	<p>41: 9.6 ↗ 42: 9.9 ↓ 43: 10.6x → 44: 10.5x ↙ 45: 10.3x ↗ 46: 10.6x ↙ 47: 10.4x ↑ 48: 9.7 → 49: 10.6x ↗ 50: 10.6x →</p> <p>Series 102.8 510.7</p>	<p>60 Shots</p> 	<p>51: 10.3x ↙ 52: 10.4x ↙ 53: 10.2x ↑ 54: 10.3x ↘ 55: 9.2 → 56: 10.1 ↓ 57: 10.3x ↑ 58: 10.1 ↑ 59: 10.0 → 60: 10.2x ↙</p> <p>Series 101.1 611.8</p>

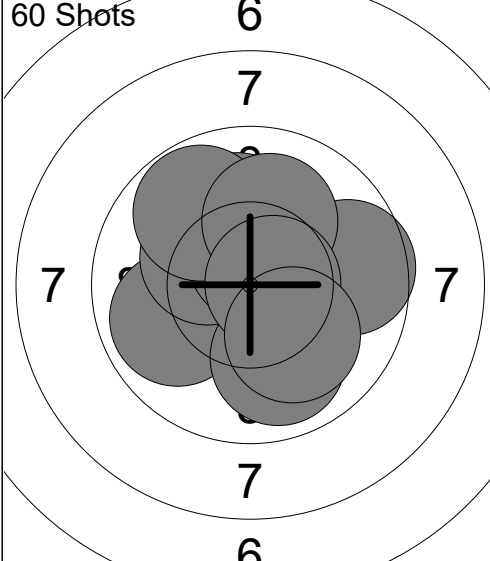
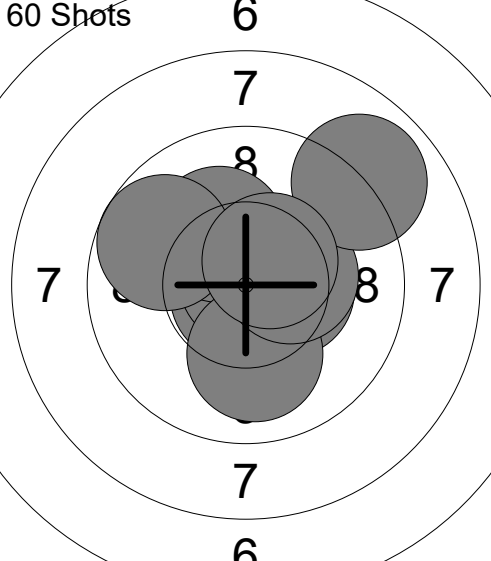
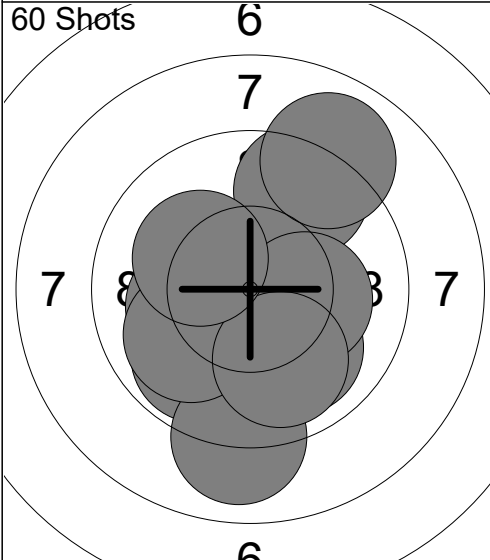
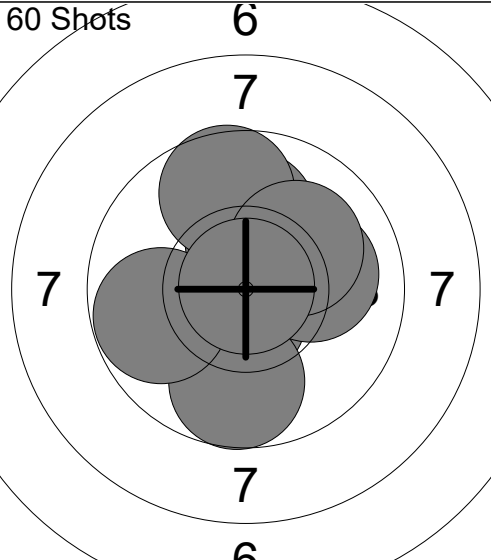
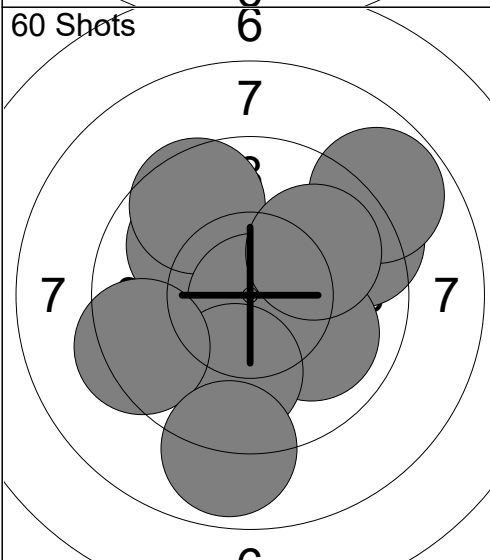
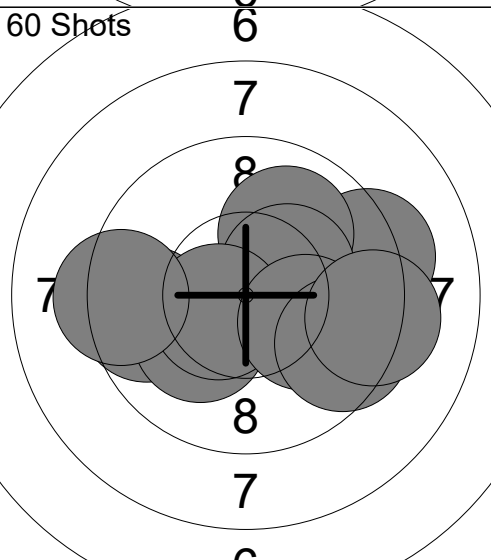
<p>60 Shots</p>  <p style="text-align: center;">6 7 7 7 7</p>	<p>1: 9.9 ↙ 2: 10.3x ↖ 3: 10.1 ↑ 4: 9.6 → 5: 10.6x ↑ 6: 9.8 ↗ 7: 10.1 ↑ 8: 9.9 ↓ 9: 10.7x → 10: 10.1 ↓</p> <p>Series 101.1 101.1</p>	<p>60 Shots</p>  <p style="text-align: center;">6 7 8 7 7</p>	<p>11: 10.8x → 12: 10.8x ↙ 13: 10.9x ↑ 14: 10.2x ↖ 15: 9.7 ↖ 16: 10.4x → 17: 10.0 ↓ 18: 10.3x → 19: 8.9 ↗ 20: 10.5x ↗</p> <p>Series 102.5 203.6</p>
<p>60 Shots</p>  <p style="text-align: center;">6 7 7 8 7</p>	<p>21: 9.5 ↗ 22: 10.0 ↓ 23: 10.2x ← 24: 9.8 ↙ 25: 9.0 ↓ 26: 10.0 ← 27: 10.2x → 28: 9.9 ↓ 29: 9.0 ↗ 30: 10.2x ↖</p> <p>Series 97.8 301.4</p>	<p>60 Shots</p>  <p style="text-align: center;">6 7 7 7 7</p>	<p>31: 10.6x → 32: 10.3x ↑ 33: 10.0 ↑ 34: 10.6x ↓ 35: 9.7 ↑ 36: 9.7 ↓ 37: 10.1 → 38: 9.8 ← 39: 10.1 ↗ 40: 10.9x ↑</p> <p>Series 101.8 403.2</p>
<p>60 Shots</p>  <p style="text-align: center;">6 7 7 7 6</p>	<p>41: 10.0 ↖ 42: 9.4 → 43: 9.6 ↗ 44: 10.8x ↓ 45: 8.8 ↗ 46: 10.0 → 47: 9.9 ↓ 48: 9.4 ← 49: 9.9 ↗ 50: 8.9 ↓</p> <p>Series 96.7 499.9</p>	<p>60 Shots</p>  <p style="text-align: center;">6 7 8 7 6</p>	<p>51: 9.3 → 52: 9.6 ← 53: 10.2x ↙ 54: 10.0 ↗ 55: 10.3x → 56: 10.5x ↙ 57: 10.1 → 58: 9.5 → 59: 9.2 → 60: 9.3 ←</p> <p>Series 98.0 597.9</p>

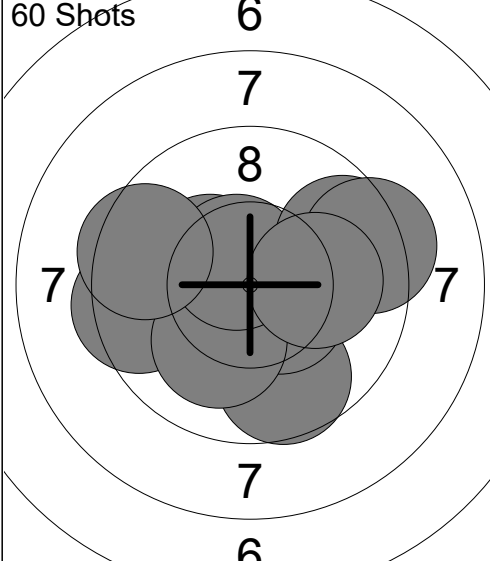
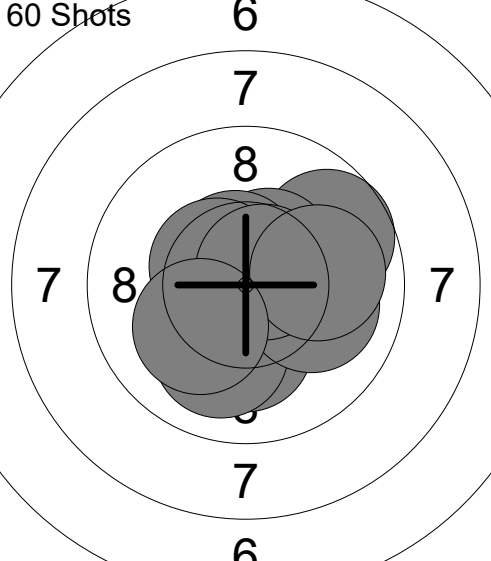
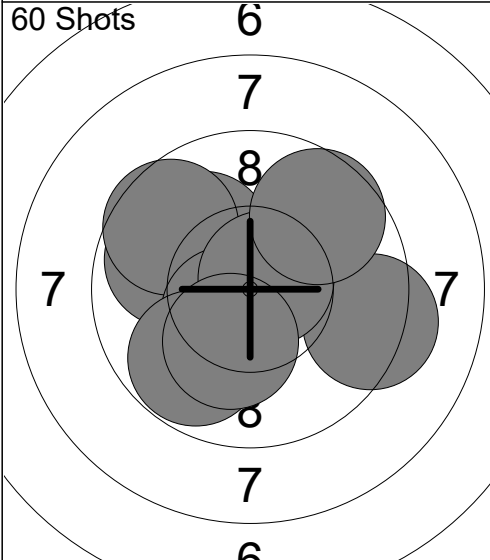
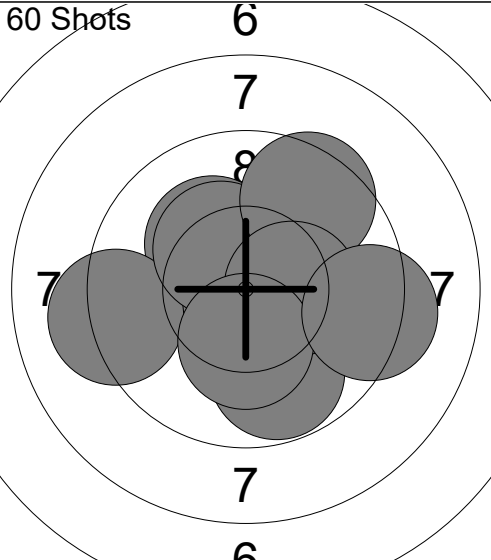
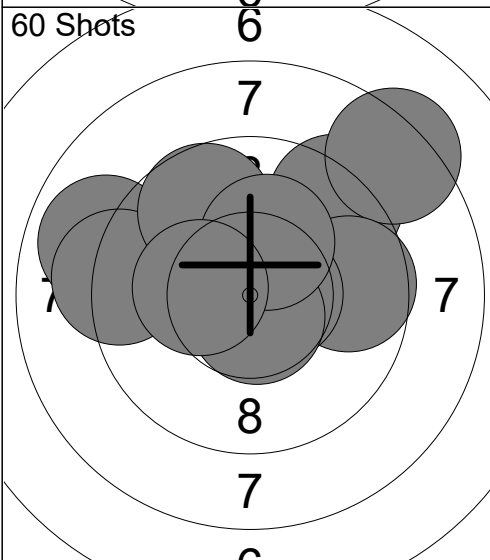
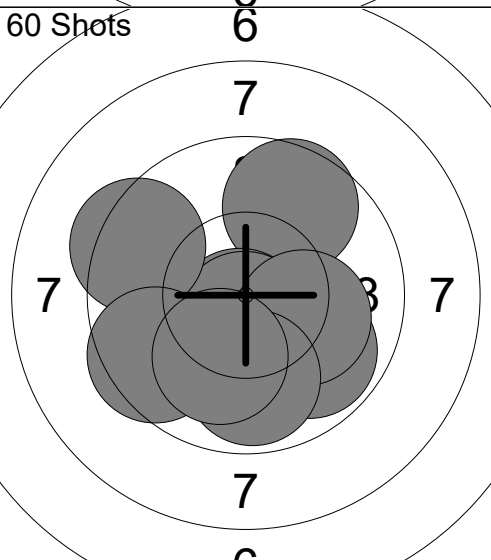
<p>60 Shots</p> 	<p>1: 9.7 ↘ 2: 10.3x ↖ 3: 9.4 ← 4: 10.5x ↘ 5: 10.1 ↘ 6: 10.6x ↗ 7: 9.6 → 8: 9.3 → 9: 10.1 → 10: 9.5 ←</p> <p>Series 99.1</p>	<p>60 Shots</p> 	<p>11: 9.7 ↗ 12: 10.2x ↓ 13: 10.5x ↗ 14: 10.6x ↗ 15: 10.0 ↓ 16: 10.5x ↖ 17: 10.0 → 18: 10.7x ↗ 19: 10.0 → 20: 10.1 ↘</p> <p>Series 102.3</p>
	99.1		201.4
<p>60 Shots</p> 	<p>21: 10.1 ← 22: 9.3 → 23: 10.0 ↗ 24: 9.8 ← 25: 9.6 ↗ 26: 10.5x ↘ 27: 10.7x ↗ 28: 9.8 ↘ 29: 9.6 ↗ 30: 10.2x ↓</p> <p>Series 99.6</p>	<p>60 Shots</p> 	<p>31: 10.2x ↖ 32: 9.9 → 33: 10.7x ↖ 34: 9.8 ↓ 35: 9.2 ← 36: 10.3x ↗ 37: 9.5 ↗ 38: 10.3x → 39: 10.3x ↓ 40: 9.3 →</p> <p>Series 99.5</p>
	301.0		400.5
<p>60 Shots</p> 	<p>41: 9.3 ↗ 42: 8.3 ↗ 43: 8.9 ← 44: 9.6 → 45: 10.6x → 46: 10.7x ↘ 47: 9.2 ← 48: 9.7 ↗ 49: 10.2x ↗ 50: 10.3x ←</p> <p>Series 96.8</p>	<p>60 Shots</p> 	<p>51: 9.8 ↘ 52: 10.7x ↓ 53: 9.6 ↗ 54: 10.7x ↓ 55: 10.6x ↓ 56: 10.1 → 57: 9.9 ↓ 58: 9.4 ← 59: 9.5 ← 60: 10.1 ↓</p> <p>Series 100.4</p>
	497.3		597.7

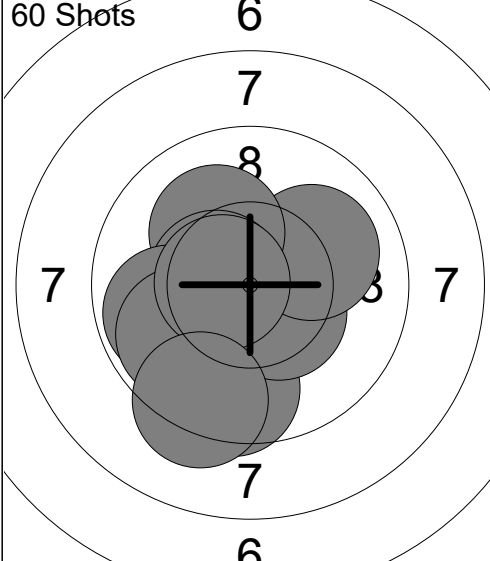
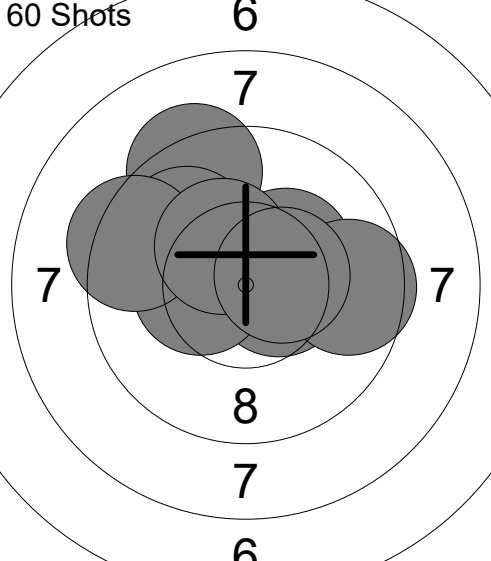
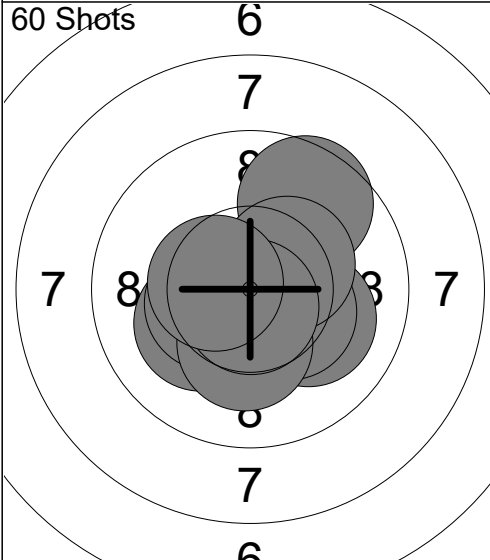
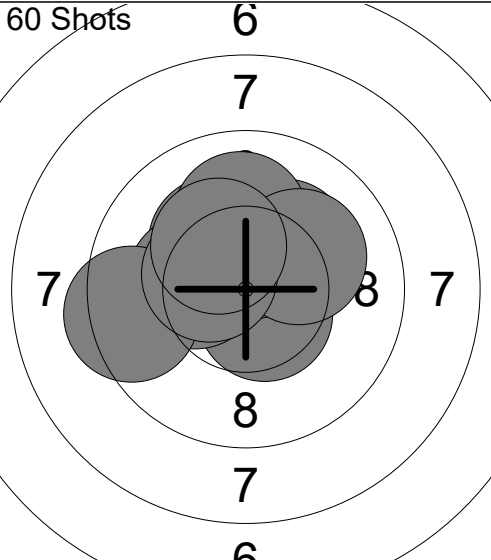
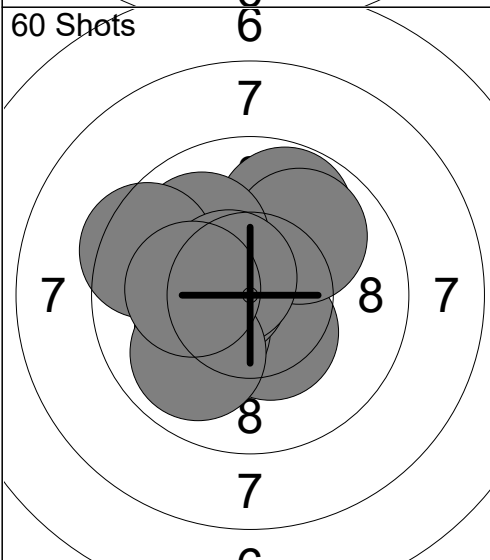
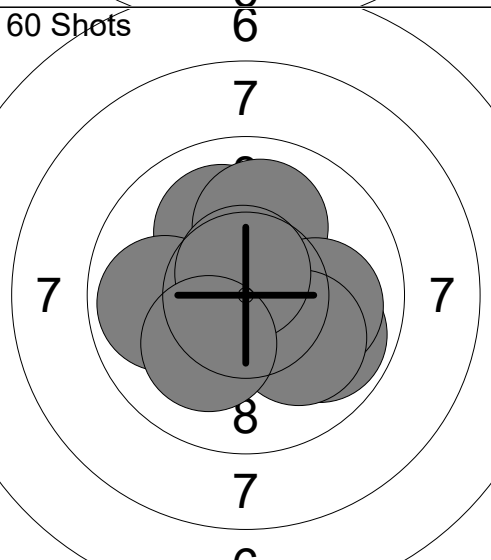
60 Shots 	1: 9.6 ↓ 2: 10.6x ↓ 3: 10.4x ↘ 4: 10.0 → 5: 10.1 ↗ 6: 10.5x ← 7: 9.8 ← 8: 9.9 ← 9: 10.6x ← 10: 9.3 ↓ <hr/> Series 100.8 100.8	60 Shots 	11: 10.5x → 12: 10.1 ↗ 13: 9.3 ↗ 14: 9.9 ↗ 15: 10.4x ← 16: 10.3x ↗ 17: 9.4 ← 18: 10.4x ↗ 19: 9.6 → 20: 10.4x → <hr/> Series 100.3 201.1
60 Shots 	21: 9.6 ↗ 22: 10.1 → 23: 10.5x → 24: 10.2x ← 25: 10.4x ← 26: 10.4x → 27: 10.2x ↓ 28: 10.4x ↗ 29: 10.7x ↓ 30: 10.5x ← <hr/> Series 103.0 304.1	60 Shots 	31: 10.5x ↘ 32: 10.4x ↑ 33: 10.2x ↗ 34: 10.2x ↗ 35: 10.3x ← 36: 10.0 ↑ 37: 10.1 ↗ 38: 9.4 ← 39: 10.4x ← 40: 10.3x ↗ <hr/> Series 101.8 405.9
60 Shots 	41: 9.8 ↗ 42: 10.4x ↓ 43: 10.2x ← 44: 10.6x ← 45: 9.9 ↗ 46: 10.0 ↗ 47: 9.5 ← 48: 10.6x ↗ 49: 9.9 ↓ 50: 10.2x ← <hr/> Series 101.1 507.0	60 Shots 	51: 10.1 ↗ 52: 10.2x → 53: 10.9x ↓ 54: 9.9 → 55: 9.9 ← 56: 10.0 ↑ 57: 10.0 → 58: 10.1 ↘ 59: 10.7x ↑ 60: 10.1 ↓ <hr/> Series 101.9 608.9

<p>60 Shots</p> <p style="text-align: center;">6 7 8 7 7 8 7 8 7 7</p>	<p>1: 10.8x ↙ 2: 10.0 ↗ 3: 10.3x ↗ 4: 9.3 ↗ 5: 10.7x ↙ 6: 9.7 → 7: 9.7 ↖ 8: 10.0 → 9: 10.7x ↗ 10: 9.8 →</p> <p>Series 101.0 101.0</p>	<p>60 Shots</p> <p style="text-align: center;">6 7 8 7 7 8 7 8 7 7</p>	<p>11: 9.9 ↘ 12: 10.6x ↙ 13: 10.5x ↘ 14: 8.4 ↑ 15: 10.3x ↗ 16: 10.5x ↖ 17: 8.9 → 18: 9.2 ↗ 19: 9.9 ↘ 20: 9.5 ↖</p> <p>Series 97.7 198.7</p>
<p>60 Shots</p> <p style="text-align: center;">6 7 8 7 7 8 7 8 7 7</p>	<p>21: 10.3x → 22: 9.4 ↑ 23: 9.9 ↘ 24: 9.6 ↑ 25: 10.1 ← 26: 10.6x ↗ 27: 10.6x ↑ 28: 10.3x ↘ 29: 9.7 ↗ 30: 10.6x ↑</p> <p>Series 101.1 299.8</p>	<p>60 Shots</p> <p style="text-align: center;">6 7 8 7 7 8 7 8 7 7</p>	<p>31: 10.5x ↖ 32: 10.3x ↗ 33: 8.8 ↖ 34: 10.4x → 35: 9.0 ↖ 36: 10.0 ↑ 37: 10.8x ↙ 38: 10.6x ↘ 39: 10.2x ↖ 40: 10.7x ↙</p> <p>Series 101.3 401.1</p>
<p>60 Shots</p> <p style="text-align: center;">6 7 8 7 7 8 7 8 7 7</p>	<p>41: 10.7x ↑ 42: 10.3x → 43: 10.6x ↘ 44: 10.4x ↖ 45: 10.2x ↙ 46: 10.0 ↙ 47: 10.5x ↑ 48: 9.7 ↘ 49: 10.4x ↙ 50: 9.7 ↑</p> <p>Series 102.5 503.6</p>	<p>60 Shots</p> <p style="text-align: center;">6 7 8 7 7 8 7 8 7 7</p>	<p>51: 10.1 → 52: 10.4x ↖ 53: 10.1 ← 54: 10.1 ↙ 55: 10.0 ↘ 56: 9.7 → 57: 10.3x → 58: 10.3x ↘ 59: 9.7 ↖ 60: 9.4 →</p> <p>Series 100.1 603.7</p>

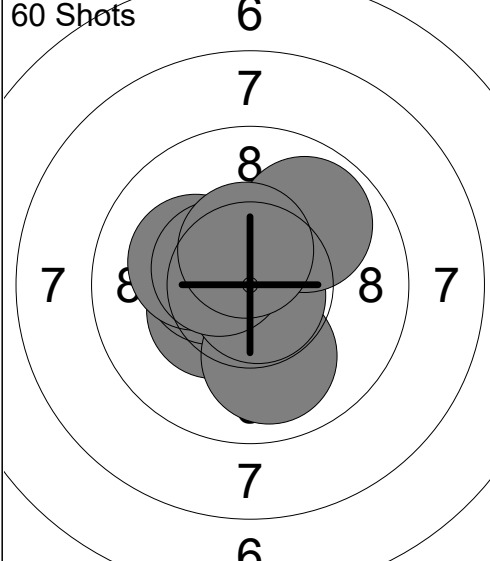
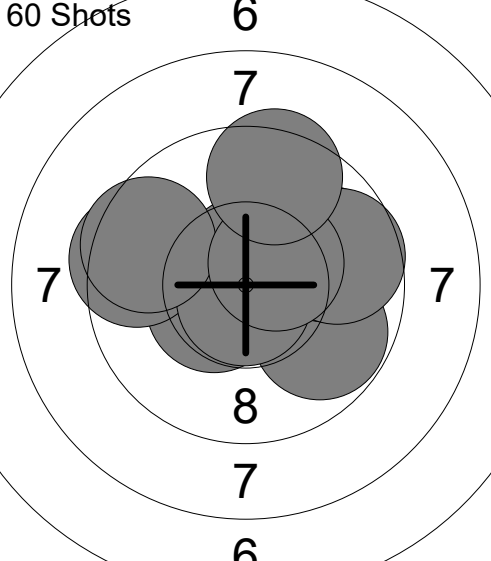
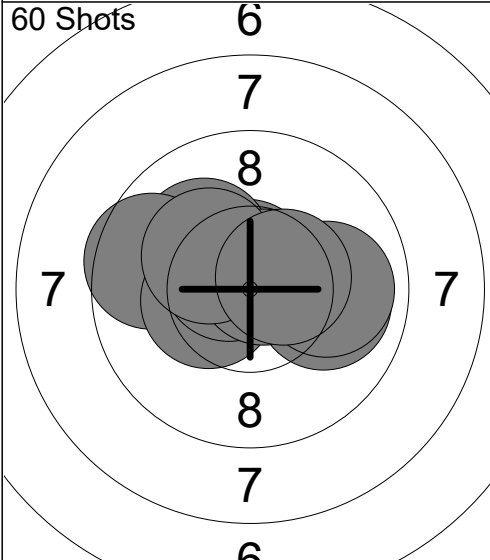
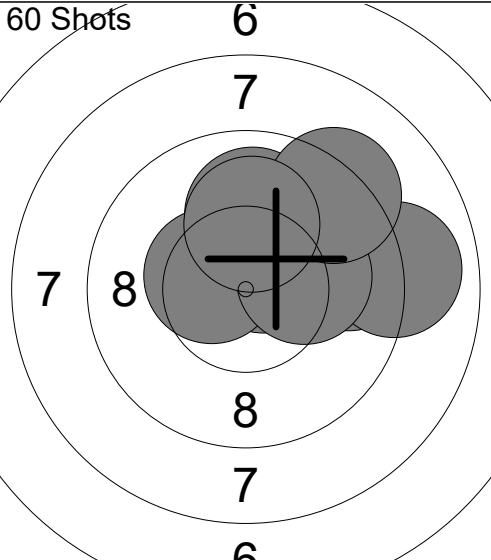
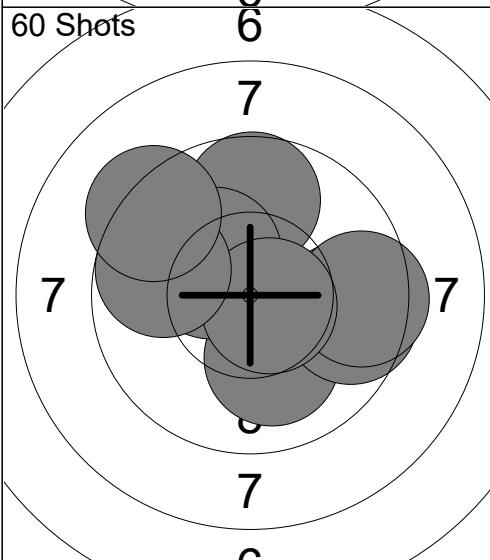
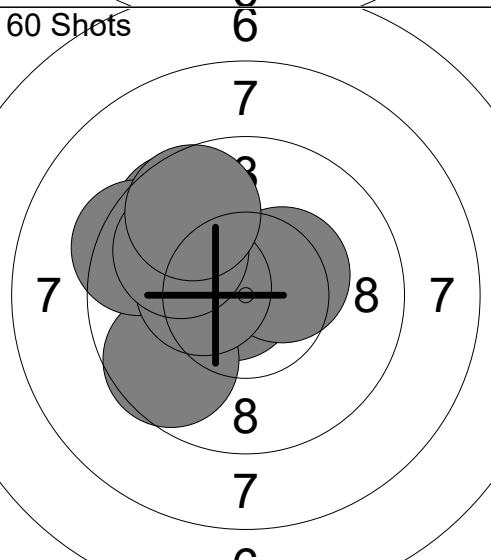
<p>60 Shots</p>  <p style="text-align: center;">6 7 8 7 7</p>	<p>1: 10.5x ↗ 2: 10.4x ↙ 3: 10.4x ← 4: 10.5x ↗ 5: 10.0 ↓ 6: 10.8x ↘ 7: 9.9 ↗ 8: 10.2x ↙ 9: 10.5x ↗ 10: 10.5x ↑</p> <p>Series 103.7 103.7</p>	<p>60 Shots</p>  <p style="text-align: center;">6 7 8 7 7</p>	<p>11: 9.8 ↘ 12: 10.5x ↙ 13: 9.5 ← 14: 10.7x ↑ 15: 10.8x ↘ 16: 9.6 ↙ 17: 9.8 → 18: 9.7 → 19: 10.5x ↗ 20: 9.5 ↑</p> <p>Series 100.4 204.1</p>
<p>60 Shots</p>  <p style="text-align: center;">6 7 8 7 7</p>	<p>21: 10.0 → 22: 10.7x ↑ 23: 9.9 → 24: 10.1 ↗ 25: 9.6 ← 26: 10.4x ↙ 27: 10.6x ↗ 28: 10.7x ↗ 29: 10.2x ↙ 30: 10.5x →</p> <p>Series 102.7 306.8</p>	<p>60 Shots</p>  <p style="text-align: center;">6 7 8 7 7</p>	<p>31: 9.8 ↗ 32: 9.5 → 33: 10.6x ↗ 34: 10.5x ↙ 35: 10.0 → 36: 10.0 ↑ 37: 9.0 → 38: 10.2x → 39: 9.2 ↗ 40: 10.1 ↑</p> <p>Series 98.9 405.7</p>
<p>60 Shots</p>  <p style="text-align: center;">6 7 8 7 6</p>	<p>41: 9.7 → 42: 10.1 ↘ 43: 9.6 → 44: 10.3x ↗ 45: 9.7 ↑ 46: 10.2x ↗ 47: 9.5 → 48: 10.7x ↘ 49: 9.8 ← 50: 9.3 ↗</p> <p>Series 98.9 504.6</p>	<p>60 Shots</p>  <p style="text-align: center;">6 7 8 7 6</p>	<p>51: 10.3x ↙ 52: 10.8x ↙ 53: 10.1 ↗ 54: 10.4x ↗ 55: 9.6 ↗ 56: 9.6 ↙ 57: 9.4 ↙ 58: 10.4x ↙ 59: 9.9 ↙ 60: 9.7 ↗</p> <p>Series 100.2 604.8</p>

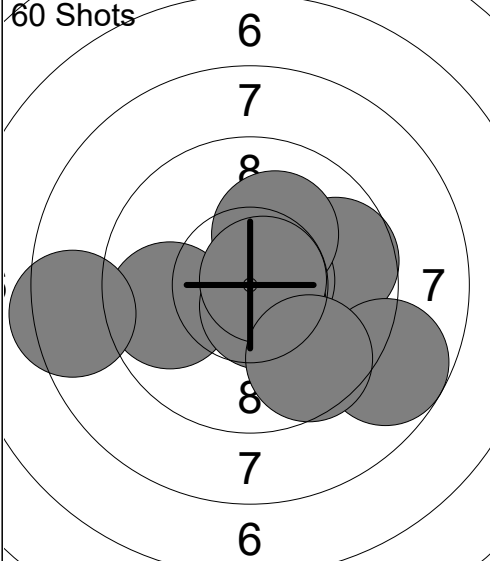
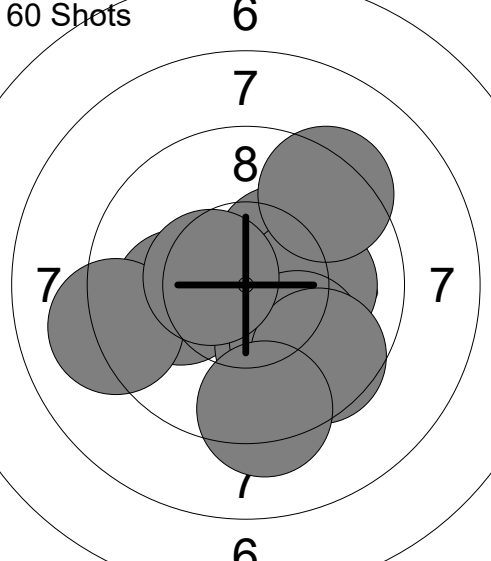
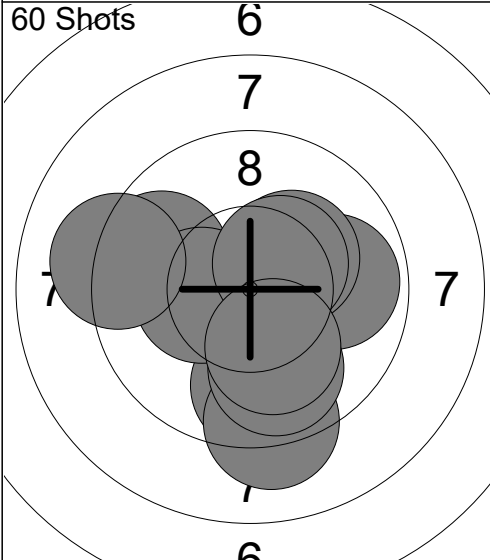
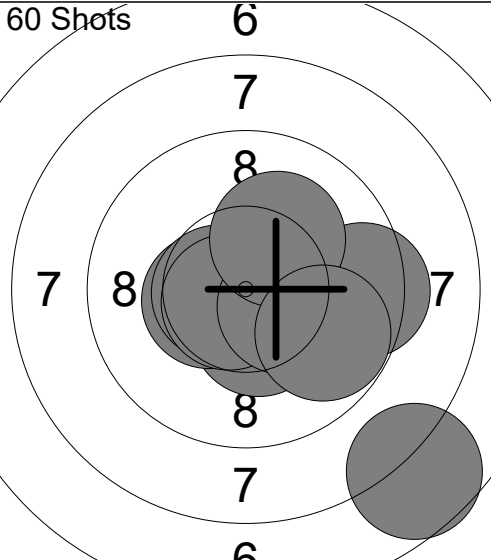
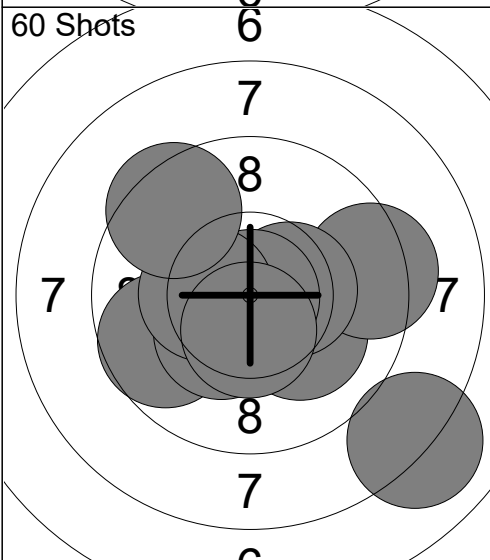
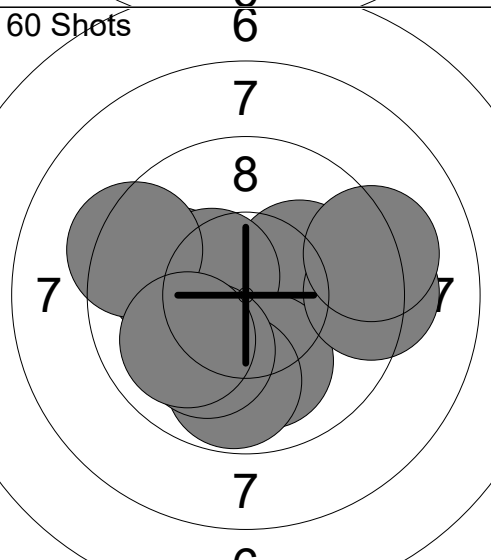
60 Shots 	1: 9.7 → 2: 10.7x → 3: 9.8 ← 4: 10.6x → 5: 8.7 ↘ 6: 10.2x ↗ 7: 10.6x ↘ 8: 10.8x → 9: 8.4 ← 10: 9.6 ↘ <hr/> Series 99.1 99.1	60 Shots 	11: 10.3x ↗ 12: 10.1 → 13: 10.1 ← 14: 10.0 ↘ 15: 9.1 ← 16: 10.0 ↘ 17: 9.6 ↘ 18: 9.3 ↘ 19: 10.5x ← 20: 9.3 ↗ <hr/> Series 98.3 197.4
60 Shots 	21: 9.7 ↓ 22: 9.2 ↓ 23: 9.7 ← 24: 9.9 → 25: 10.3x ↗ 26: 10.3x ← 27: 9.9 ↓ 28: 9.2 ← 29: 10.4x ↗ 30: 10.1 ↓ <hr/> Series 98.7 296.1	60 Shots 	31: 10.8x ↘ 32: 10.4x ↘ 33: 10.4x ← 34: 9.4 → 35: 10.6x ← 36: 10.7x ← 37: 10.4x → 38: 10.2x ↗ 39: 9.8 ↘ 40: 7.7 ↘ <hr/> Series 100.4 396.5
60 Shots 	41: 9.7 ← 42: 10.3x ↘ 43: 10.1 ↘ 44: 9.3 → 45: 10.4x → 46: 10.9x ↘ 47: 10.4x ← 48: 8.0 ↘ 49: 9.4 ↗ 50: 10.5x ↓ <hr/> Series 99.0 495.5	60 Shots 	51: 10.0 ← 52: 10.1 ↗ 53: 10.4x ← 54: 10.0 ↘ 55: 9.4 ← 56: 9.3 → 57: 9.8 ↓ 58: 10.1 ↘ 59: 10.0 ← 60: 9.2 → <hr/> Series 98.3 593.8

<p>60 Shots</p>	<p>1: 9.8 ↖</p> <p>2: 9.1 ←</p> <p>3: 10.3x ↙</p> <p>4: 10.0 ↓</p> <p>5: 10.2x ↙</p> <p>6: 10.1 ↗</p> <p>7: 9.3 →</p> <p>8: 9.3 →</p> <p>9: 9.4 ↖</p> <p>10: 9.5 ↓</p> <hr/> <p>Series 97.0</p> <p style="text-align: right;">97.0</p>	<p>60 Shots</p>	<p>11: 8.6 ↑</p> <p>12: 9.6 ↓</p> <p>13: 9.2 ⇒</p> <p>14: 9.2 ↗</p> <p>15: 8.7 ←</p> <p>16: 10.0 ↓</p> <p>17: 10.3x ↙</p> <p>18: 9.7 ↓</p> <p>19: 8.6 ←</p> <p>20: 9.6 ↙</p> <hr/> <p>Series 93.5</p> <p style="text-align: right;">190.5</p>
<p>60 Shots</p>	<p>21: 8.4 ←</p> <p>22: 8.5 ←</p> <p>23: 10.4x ↙</p> <p>24: 9.0 ←</p> <p>25: 10.1 ↑</p> <p>26: 10.2x ↗</p> <p>27: 10.0 ↓</p> <p>28: 9.9 ←</p> <p>29: 9.1 ↑</p> <p>30: 10.1 ←</p> <hr/> <p>Series 95.7</p> <p style="text-align: right;">286.2</p>	<p>60 Shots</p>	<p>31: 10.3x ↖</p> <p>32: 9.8 ↑</p> <p>33: 9.2 ↑</p> <p>34: 7.5 ⇒</p> <p>35: 10.6x ↑</p> <p>36: 9.2 →</p> <p>37: 9.2 ←</p> <p>38: 9.8 ↑</p> <p>39: 9.2 ↓</p> <p>40: 10.1 ↘</p> <hr/> <p>Series 94.9</p> <p style="text-align: right;">381.1</p>
<p>60 Shots</p>	<p>41: 8.0 ⇒</p> <p>42: 8.6 →</p> <p>43: 9.0 ↘</p> <p>44: 8.1 →</p> <p>45: 10.4x ↗</p> <p>46: 10.7x ↓</p> <p>47: 8.9 ↓</p> <p>48: 9.8 ↓</p> <p>49: 10.5x ↓</p> <p>50: 9.6 ↘</p> <hr/> <p>Series 93.6</p> <p style="text-align: right;">474.7</p>	<p>60 Shots</p>	<p>51: 10.2x ↙</p> <p>52: 10.3x ↙</p> <p>53: 9.6 ←</p> <p>54: 9.9 ↘</p> <p>55: 10.1 ↗</p> <p>56: 9.4 ↙</p> <p>57: 10.6x ↑</p> <p>58: 9.5 ↓</p> <p>59: 10.0 ↓</p> <p>60: 9.0 ↙</p> <hr/> <p>Series 98.6</p> <p style="text-align: right;">573.3</p>

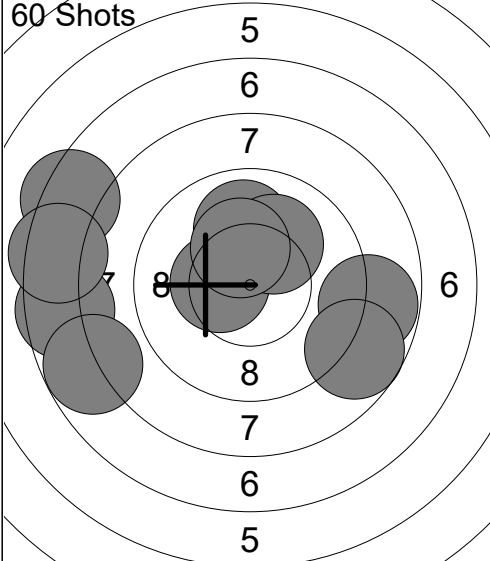
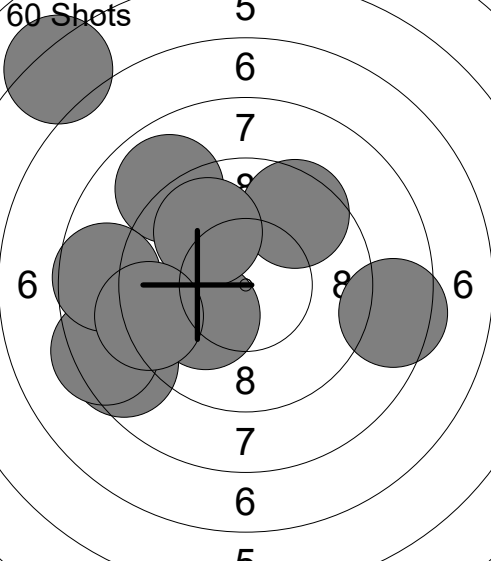
<p>60 Shots</p>  <p style="text-align: center;">5 6 7 8 7 6 5</p>	<p>1: 8.8 → 2: 7.6 ← 3: 7.4 ← 4: 10.4x ← 5: 7.4 ← 6: 8.7 → 7: 9.9 ↑ 8: 10.1 ↗ 9: 10.3x ↑ 10: 7.8 ←</p> <p>Series 88.4 88.4</p>	<p>60 Shots</p>  <p style="text-align: center;">5 6 7 8 7 6 5</p>	<p>11: 8.6 ↙ 12: 8.5 → 13: 10.1 ↙ 14: 6.2 ↗ 15: 9.5 ↗ 16: 8.4 ← 17: 8.9 ↗ 18: 8.6 ← 19: 9.9 ↗ 20: 9.3 ←</p> <p>Series 88.0 176.4</p>
---	--	---	--

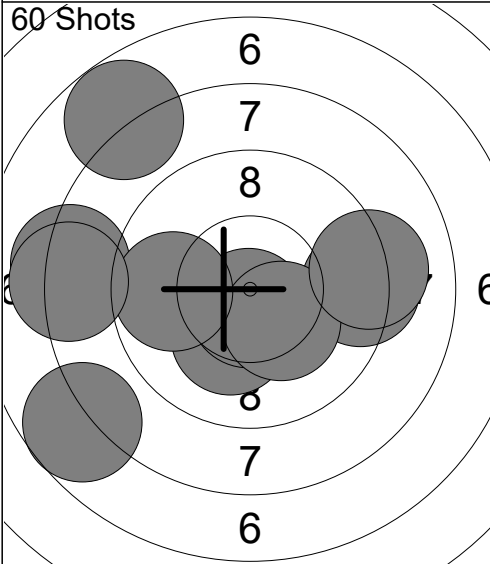
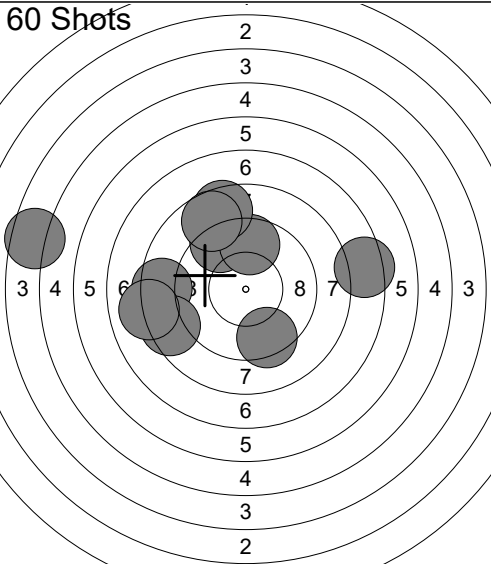
<p>60 Shots</p>  <p style="text-align: center;">6 7 8 6 7 6</p>	<p>21: 10.2x ↓ 22: 10.7x ↓ 23: 9.3 → 24: 8.2 ← 25: 10.3x ↓ 26: 9.1 → 27: 7.8 ↗ 28: 9.8 ← 29: 8.2 ← 30: 7.7 ↙</p> <p>Series 91.3 267.7</p>	<p>60 Shots</p>  <p style="text-align: center;">2 3 4 5 6 7 8 7 6 5 4 3 2</p>	<p>31: 4.5 ← 32: 8.5 ← 33: 9.4 ↗ 34: 9.6 ↑ 35: 9.4 ↓ 36: 8.5 ↑ 37: 7.4 → 38: 8.7 ↗ 39: 8.5 ← 40: 8.0 ←</p> <p>Series 82.5 350.2</p>
--	---	--	---

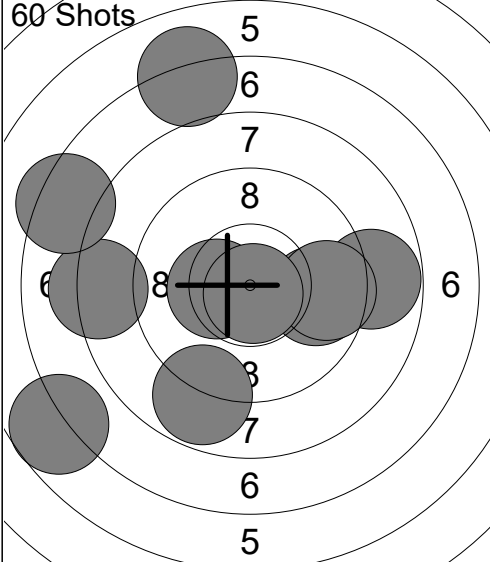
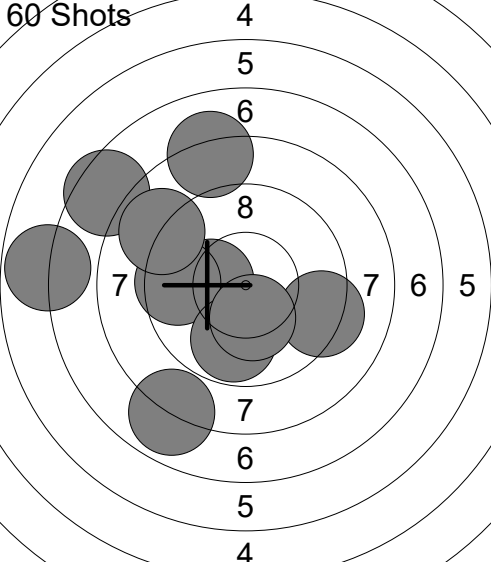
<p>60 Shots</p>  <p style="text-align: center;">5 6 7 8 6 5</p>	<p>41: 9.8 → 42: 8.2 ← 43: 8.8 ↓ 44: 8.8 → 45: 7.3 ← 46: 7.0 ↑ 47: 10.3x ← 48: 6.7 ← 49: 9.6 → 50: 10.8x ↓</p> <p>Series 87.3 437.5</p>	<p>60 Shots</p>  <p style="text-align: center;">4 5 6 8 7 7 6 5 7 6 5 4</p>	<p>51: 10.2x ← 52: 7.9 ↙ 53: 8.1 ↑ 54: 9.3 → 55: 9.5 ← 56: 7.5 ↗ 57: 9.8 ↓ 58: 6.8 ← 59: 10.3x ↓ 60: 8.9 ↙</p> <p>Series 88.3 525.8</p>
---	---	---	---

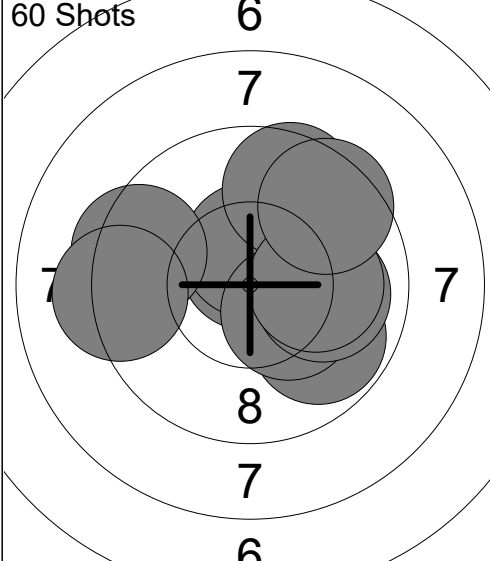
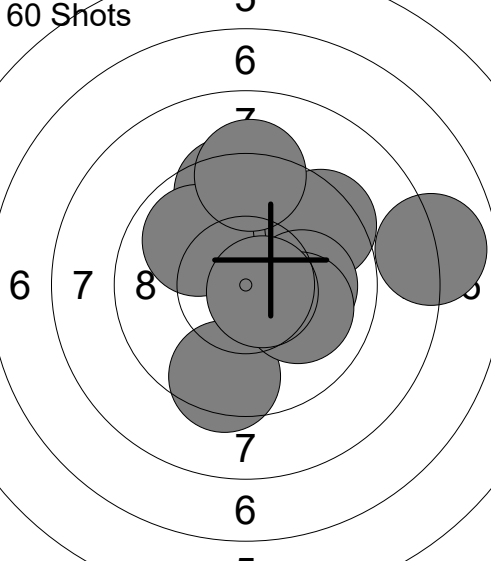
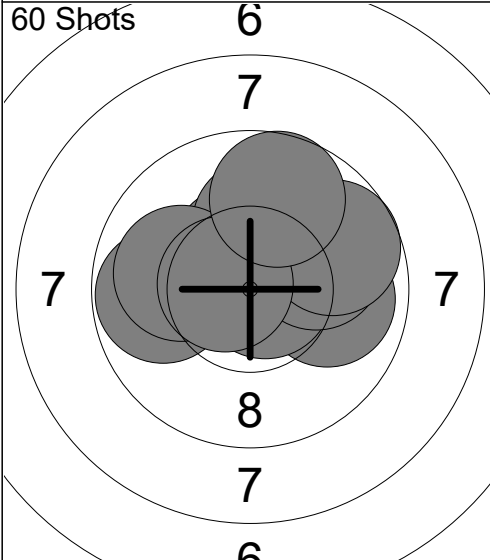
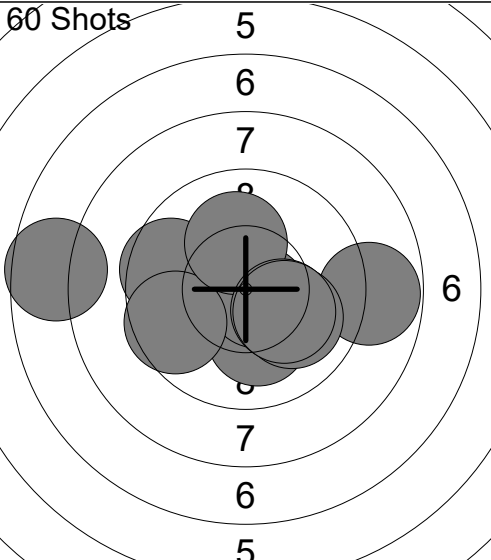
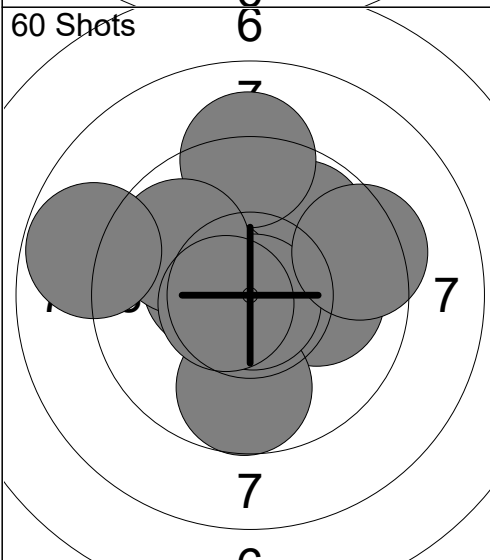
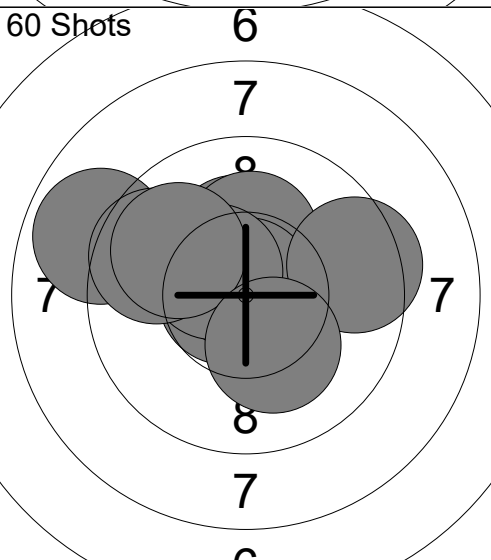
<p>60 Shots</p> 	<p>1: 10.6x ↑</p> <p>2: 9.8 ↘</p> <p>3: 10.5x ↑</p> <p>4: 10.3x ↘</p> <p>5: 9.4 ←</p> <p>6: 9.6 ↑</p> <p>7: 10.0 →</p> <p>8: 10.1 →</p> <p>9: 9.2 ←</p> <p>10: 9.5 ↗</p> <hr/> <p>Series 99.0</p> <hr/> <p>99.0</p>	<p>60 Shots</p> 	<p>11: 10.1 ↖</p> <p>12: 9.5 ↓</p> <p>13: 7.9 →</p> <p>14: 9.5 ↑</p> <p>15: 9.4 ↗</p> <p>16: 10.1 →</p> <p>17: 10.0 ↘</p> <p>18: 9.9 ↗</p> <p>19: 9.2 ↑</p> <p>20: 10.7x ↘</p> <hr/> <p>Series 96.3</p> <hr/> <p>195.3</p>
<p>60 Shots</p> 	<p>21: 10.4x ↑</p> <p>22: 9.9 →</p> <p>23: 10.7x →</p> <p>24: 9.8 ←</p> <p>25: 10.0 →</p> <p>26: 10.1 ↑</p> <p>27: 10.0 ←</p> <p>28: 9.7 ↗</p> <p>29: 10.6x ←</p> <p>30: 9.7 ↑</p> <hr/> <p>Series 100.9</p> <hr/> <p>296.2</p>	<p>60 Shots</p> 	<p>31: 10.1 ↓</p> <p>32: 10.7x ↘</p> <p>33: 9.6 ←</p> <p>34: 9.6 ←</p> <p>35: 10.1 ↑</p> <p>36: 8.8 →</p> <p>37: 7.6 ←</p> <p>38: 10.2x ↘</p> <p>39: 10.0 ↘</p> <p>40: 10.2x ↘</p> <hr/> <p>Series 96.9</p> <hr/> <p>393.1</p>
<p>60 Shots</p> 	<p>41: 10.1 →</p> <p>42: 9.8 ↗</p> <p>43: 9.7 ↓</p> <p>44: 9.2 ↑</p> <p>45: 10.4x ←</p> <p>46: 10.8x ↓</p> <p>47: 9.8 ↖</p> <p>48: 10.6x ←</p> <p>49: 9.4 →</p> <p>50: 8.8 ←</p> <hr/> <p>Series 98.6</p> <hr/> <p>491.7</p>	<p>60 Shots</p> 	<p>51: 8.9 ←</p> <p>52: 10.3x ↑</p> <p>53: 10.2x ↑</p> <p>54: 10.7x ←</p> <p>55: 10.8x ↑</p> <p>56: 10.4x ↖</p> <p>57: 9.7 ←</p> <p>58: 9.9 ↖</p> <p>59: 9.5 →</p> <p>60: 10.2x ↓</p> <hr/> <p>Series 100.6</p> <hr/> <p>592.3</p>

<p>60 Shots</p> <p style="text-align: center;">6 7 7 6</p>	<p>1: 10.1 ←</p> <p>2: 10.5x ↖</p> <p>3: 9.5 ↗</p> <p>4: 10.0 ↑</p> <p>5: 10.2x ↑</p> <p>6: 9.4 ↘</p> <p>7: 9.1 →</p> <p>8: 10.0 ⇨</p> <p>9: 10.5x ←</p> <p>10: 9.5 ↘</p> <hr/> <p>Series 98.8</p> <hr/> <p style="text-align: center;">98.8</p>	<p>60 Shots</p> <p style="text-align: center;">6 7 8 7 6</p>	<p>11: 10.4x ↓</p> <p>12: 10.9x ↓</p> <p>13: 9.1 ←</p> <p>14: 9.6 ↗</p> <p>15: 8.3 ←</p> <p>16: 8.8 ↘</p> <p>17: 8.0 ←</p> <p>18: 10.2x ↓</p> <p>19: 8.4 ⇨</p> <p>20: 9.9 ↘</p> <hr/> <p>Series 93.6</p> <hr/> <p style="text-align: center;">192.4</p>
--	--	--	---

<p>60 Shots</p> <p style="text-align: center;">5 6 7 8 6 5</p>	<p>21: 9.1 ↓</p> <p>22: 9.7 ↓</p> <p>23: 9.9 ←</p> <p>24: 9.1 ↖</p> <p>25: 9.0 ↗</p> <p>26: 9.5 ↘</p> <p>27: 10.1 ↓</p> <p>28: 9.8 ↓</p> <p>29: 9.9 ⇨</p> <p>30: 7.2 →</p> <hr/> <p>Series 93.3</p> <hr/> <p style="text-align: center;">285.7</p>	<p>60 Shots</p> <p style="text-align: center;">5 6 7 8 6 5</p>	<p>31: 7.5 →</p> <p>32: 10.6x ↖</p> <p>33: 9.9 ↘</p> <p>34: 10.0 ←</p> <p>35: 10.7x ↑</p> <p>36: 9.1 →</p> <p>37: 10.0 ⇨</p> <p>38: 10.1 ↗</p> <p>39: 9.5 ↘</p> <p>40: 9.4 ↘</p> <hr/> <p>Series 96.8</p> <hr/> <p style="text-align: center;">382.5</p>
--	--	--	--

<p>60 Shots</p> <p style="text-align: center;">6 7 6 6</p>	<p>41: 9.2 ↓</p> <p>42: 9.9 →</p> <p>43: 8.1 ⇨</p> <p>44: 9.0 ↗</p> <p>45: 9.9 ↗</p> <p>46: 8.9 ←</p> <p>47: 8.9 ↘</p> <p>48: 10.3x ↓</p> <p>49: 9.6 ←</p> <p>50: 8.3 ↑</p> <hr/> <p>Series 92.1</p> <hr/> <p style="text-align: center;">474.6</p>	<p>60 Shots</p> <p style="text-align: center;">5 6 7 6 5</p>	<p>51: 10.5x ←</p> <p>52: 9.5 ↑</p> <p>53: 9.8 ↓</p> <p>54: 9.2 →</p> <p>55: 10.0 ⇨</p> <p>56: 8.5 ↗</p> <p>57: 8.1 ←</p> <p>58: 10.0 ←</p> <p>59: 9.7 ⇨</p> <p>60: 7.7 ⇨</p> <hr/> <p>Series 93.0</p> <hr/> <p style="text-align: center;">567.6</p>
--	---	--	---

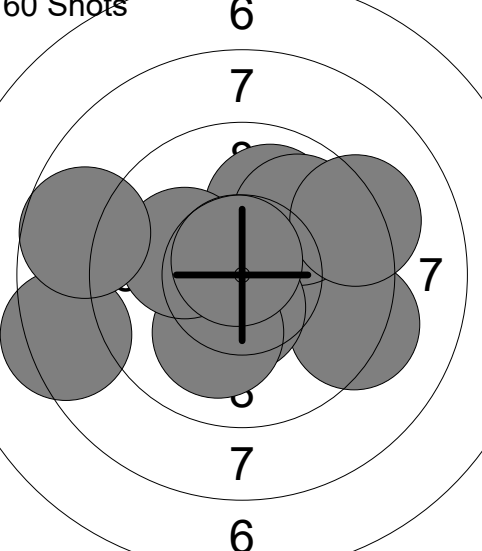
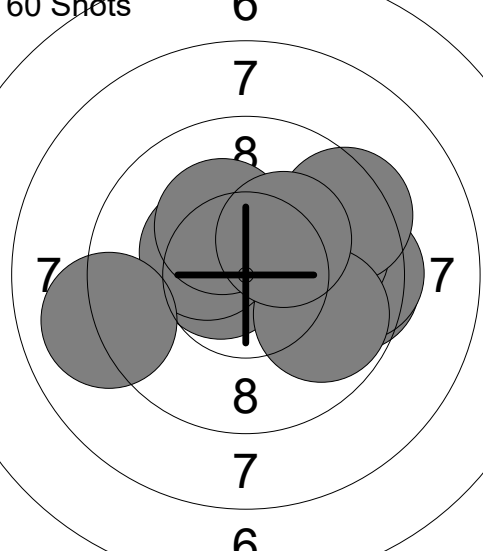
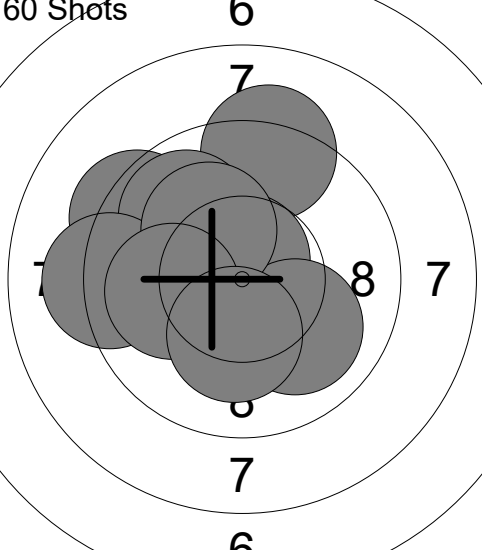
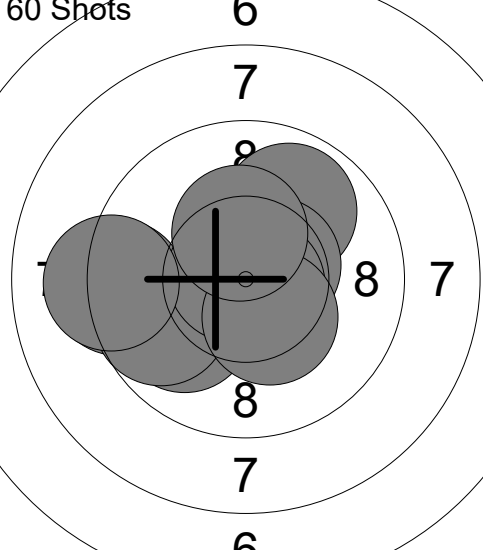
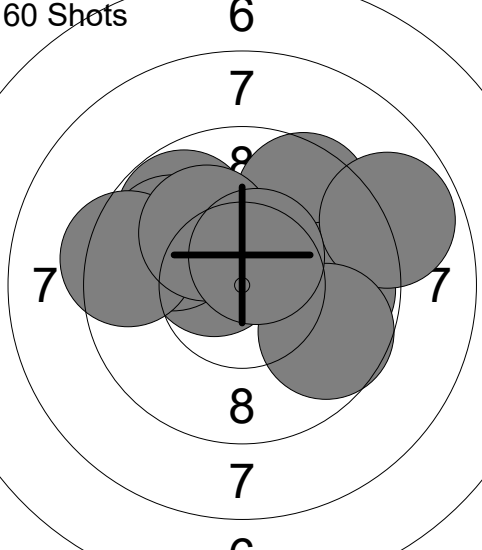
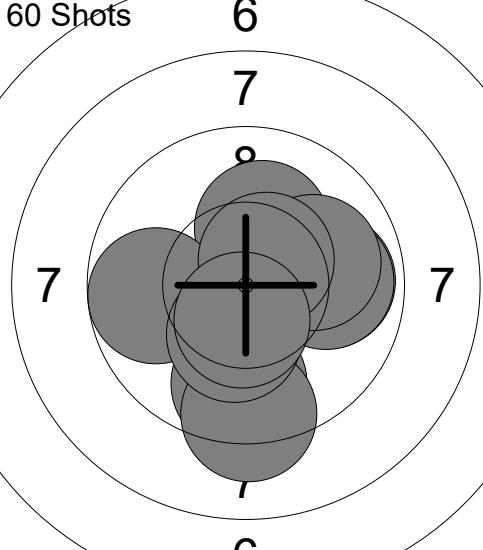
60 Shots 	1: 10.0 ↗ 2: 9.3 → 3: 8.4 ← 4: 9.9 ↗ 5: 10.5x ↓ 6: 10.1 ↓ 7: 9.2 → 8: 10.1 ← 9: 8.7 ← 10: 10.7x ↗ <hr/> Series 96.9 96.9	60 Shots 	11: 10.6x ← 12: 10.4x ↖ 13: 9.5 → 14: 9.5 → 15: 9.9 → 16: 9.4 ↗ 17: 9.0 ← 18: 10.2x ↗ 19: 9.8 → 20: 10.3x ↗ <hr/> Series 98.6 195.5
60 Shots 	21: 9.2 ↗ 22: 9.3 ↖ 23: 10.6x ↗ 24: 9.9 ↗ 25: 10.7x ↗ 26: 9.2 ← 27: 10.0 ↘ 28: 10.2x ↗ 29: 10.0 ← 30: 10.2x ↓ <hr/> Series 99.3 294.8	60 Shots 	31: 9.9 ↗ 32: 9.3 ← 33: 10.5x ↗ 34: 9.9 ↖ 35: 10.8x → 36: 9.7 ← 37: 10.8x ↖ 38: 10.4x ↘ 39: 9.2 ← 40: 10.3x ↗ <hr/> Series 100.8 395.6
60 Shots 	41: 9.6 ↗ 42: 9.8 → 43: 10.5x ↖ 44: 9.8 ↗ 45: 9.9 ↗ 46: 9.4 ← 47: 8.8 → 48: 10.1 ↗ 49: 9.7 → 50: 10.5x ↗ <hr/> Series 98.1 493.7	60 Shots 	51: 10.2x ↗ 52: 9.6 ↓ 53: 9.9 → 54: 9.2 ↓ 55: 9.8 ← 56: 9.9 → 57: 10.0 → 58: 10.5x ↗ 59: 10.3x ↓ 60: 10.5x ↓ <hr/> Series 99.9 593.6

<p>60 Shots</p>	<p>1: 8.7 ←</p> <p>2: 9.6 ←</p> <p>3: 9.3 ↖</p> <p>4: 9.0 ↗</p> <p>5: 10.1 ↗</p> <p>6: 10.3x ↑</p> <p>7: 9.0 ←</p> <p>8: 9.0 ↑</p> <p>9: 7.9 →</p> <p>10: 9.4 ↗</p> <hr/> <p>Series 92.3</p> <p style="text-align: center;">92.3</p>	<p>60 Shots</p>	<p>11: 9.8 ↗</p> <p>12: 10.0 ➡</p> <p>13: 9.8 ↑</p> <p>14: 9.3 ←</p> <p>15: 10.0 ↑</p> <p>16: 10.1 ←</p> <p>17: 8.9 ↖</p> <p>18: 10.0 ↑</p> <p>19: 9.1 ↑</p> <p>20: 9.7 ↖</p> <hr/> <p>Series 96.7</p> <p style="text-align: center;">189.0</p>
<p>60 Shots</p>	<p>21: 10.2x ➡</p> <p>22: 10.5x ➡</p> <p>23: 9.7 ↑</p> <p>24: 10.6x ←</p> <p>25: 10.1 ←</p> <p>26: 10.1 ↑</p> <p>27: 10.0 ↓</p> <p>28: 9.6 ←</p> <p>29: 9.8 ↓</p> <p>30: 10.7x ↖</p> <hr/> <p>Series 101.3</p> <p style="text-align: center;">290.3</p>	<p>60 Shots</p>	<p>31: 9.4 ←</p> <p>32: 10.4x ↑</p> <p>33: 10.0 ➡</p> <p>34: 10.4x ↓</p> <p>35: 10.2x ↙</p> <p>36: 10.0 ↑</p> <p>37: 9.2 ←</p> <p>38: 9.9 ↑</p> <p>39: 9.5 ←</p> <p>40: 10.4x ↓</p> <hr/> <p>Series 99.4</p> <p style="text-align: center;">389.7</p>
<p>60 Shots</p>	<p>41: 9.2 ➡</p> <p>42: 10.3x ↑</p> <p>43: 9.5 ↙</p> <p>44: 10.9x ↙</p> <p>45: 10.1 ↓</p> <p>46: 10.0 ↗</p> <p>47: 9.9 ←</p> <p>48: 10.2x ↗</p> <p>49: 8.9 ←</p> <p>50: 10.5x ↙</p> <hr/> <p>Series 99.5</p> <p style="text-align: center;">489.2</p>	<p>60 Shots</p>	<p>51: 9.4 ↖</p> <p>52: 10.3x ←</p> <p>53: 9.9 ↖</p> <p>54: 8.8 ↖</p> <p>55: 10.3x ➡</p> <p>56: 9.7 ↗</p> <p>57: 9.7 ➡</p> <p>58: 10.4x ←</p> <p>59: 10.2x ➡</p> <p>60: 10.3x ↘</p> <hr/> <p>Series 99.0</p> <p style="text-align: center;">588.2</p>

Relay **5** Lane **20** **ALLEN Khamrynn**

1-80 Marion 1 Precision

31.01.2025 2025 AirNats by X Count Civilian Marksmanship Program

Comment Signature

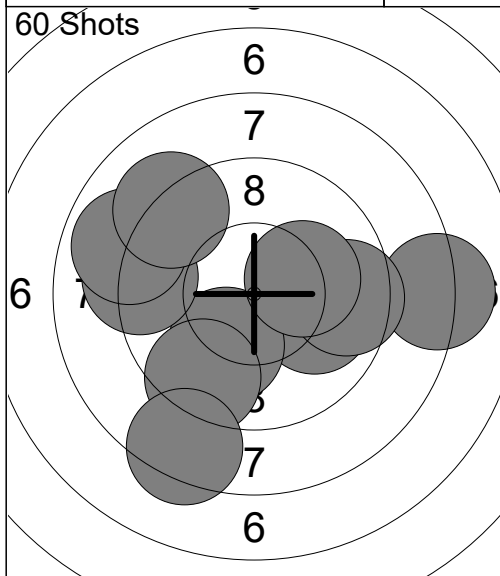

1:	10.0	→
2:	10.1	↓
3:	9.2	←
4:	8.9	←
5:	8.1	→
6:	9.4	↓
7:	9.1	↗
8:	9.5	→
9:	10.2x	→
10:	8.4	↓
Series	92.9	
	92.9	

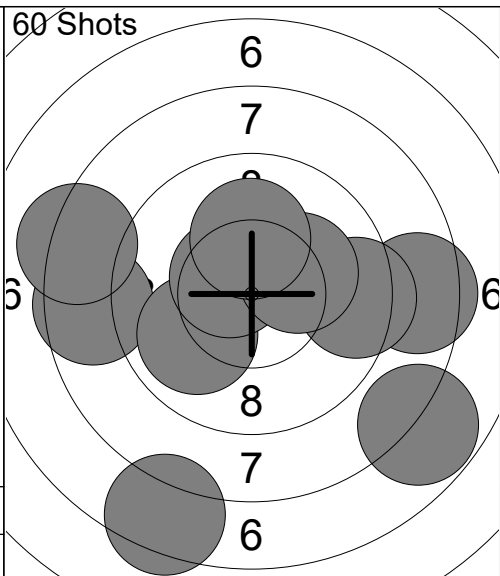

11:	8.5	→
12:	8.6	←
13:	9.9	↙
14:	7.8	↘
15:	7.4	↓
16:	9.4	→
17:	10.5x	↖
18:	8.2	←
19:	10.2x	↗
20:	10.1	↑
Series	90.6	
	183.5	

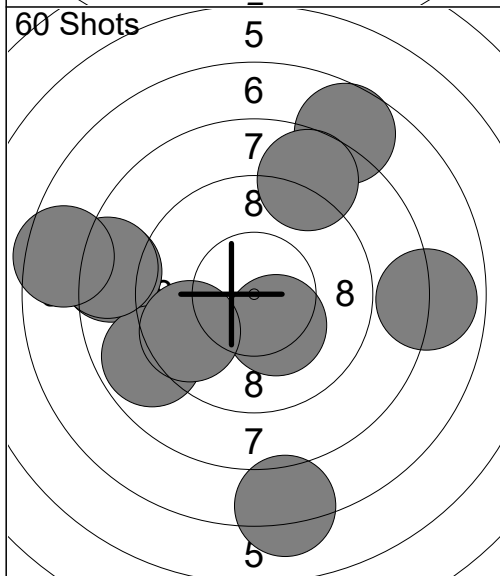

21:	7.9	→
22:	8.4	←
23:	8.8	←
24:	8.3	←
25:	7.7	↑
26:	10.3x	↘
27:	9.6	←
28:	8.7	↑
29:	7.5	←
30:	7.2	↓
Series	84.4	
	267.9	

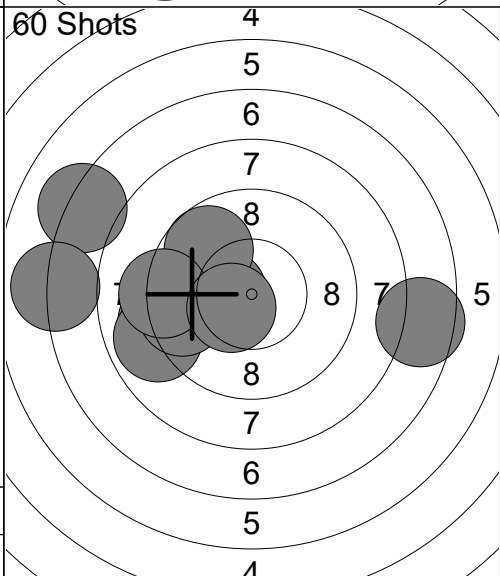

31:	7.1	←
32:	9.1	←
33:	10.4x	←
34:	9.7	↗
35:	8.9	←
36:	9.5	←
37:	7.5	→
38:	9.2	←
39:	10.5x	↙
40:	7.0	←
Series	88.9	
	356.8	

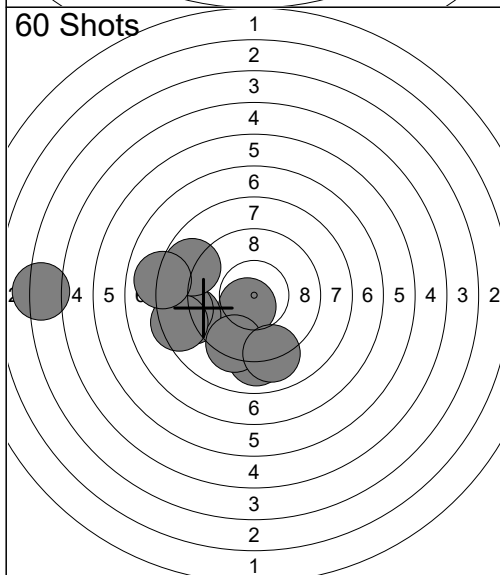

41:	10.5x	↘
42:	8.9	←
43:	8.7	←
44:	9.0	↓
45:	9.3	↘
46:	8.4	←
47:	9.0	↓
48:	4.2	←
49:	8.8	←
50:	8.0	←
Series	84.8	
	441.6	

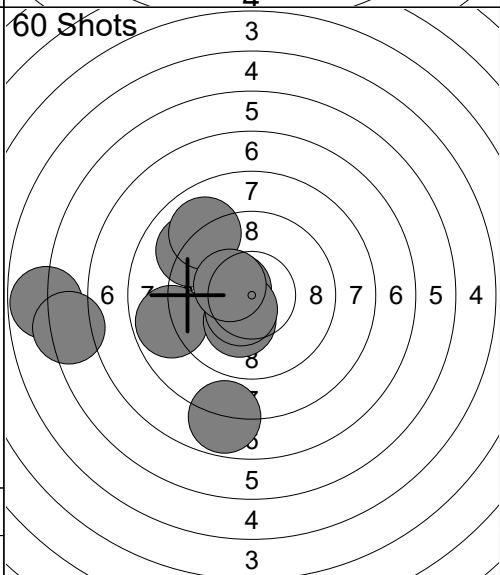

51:	7.8	↓
52:	8.8	←
53:	5.8	←
54:	9.1	↗
55:	9.0	↗
56:	6.3	←
57:	10.5x	↖
58:	10.2x	↘
59:	10.5x	↙
60:	10.3x	↖
Series	88.3	
	529.9	

Comment	Signature		
---------	-----------	--	--

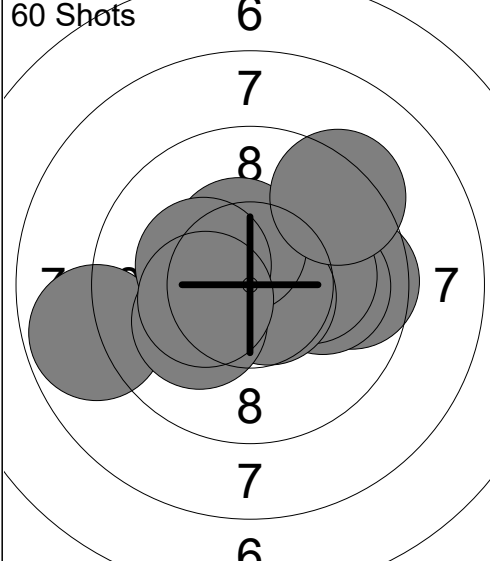
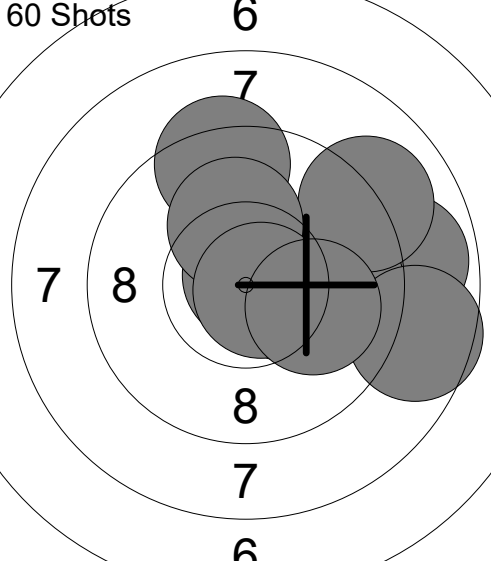
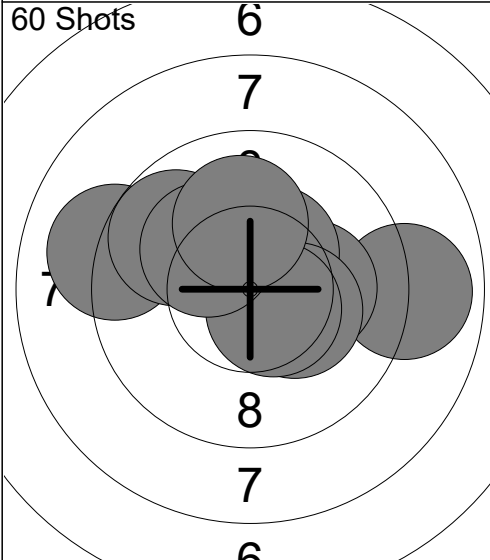
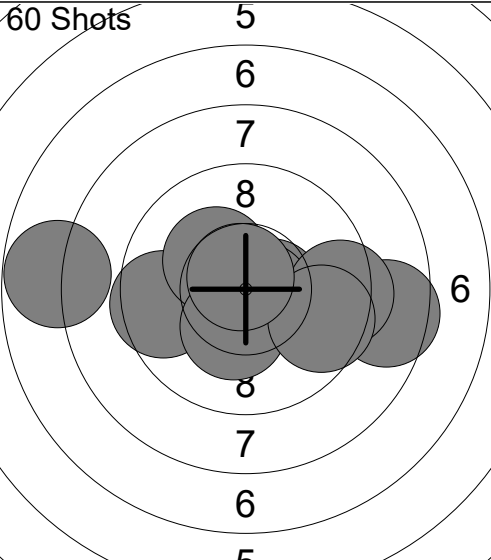
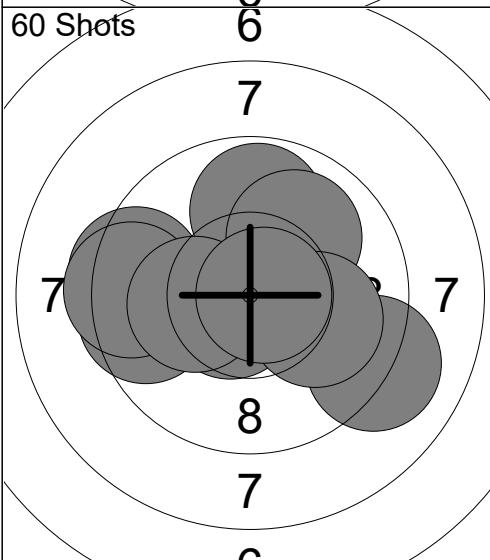
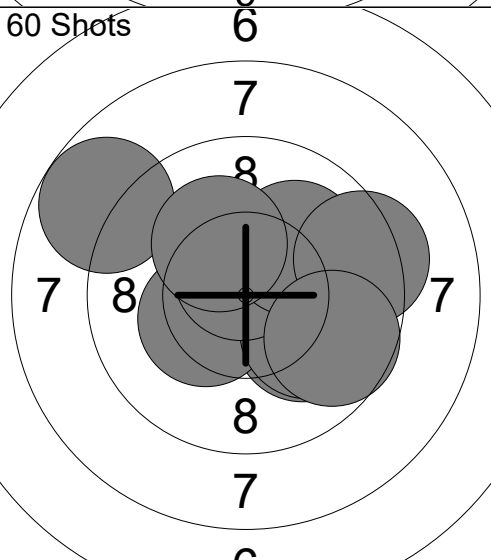
60 Shots 	1: 9.6 → 2: 10.0 → 3: 10.2x → 4: 8.8 ← 5: 10.7x ↘ 6: 10.4x ↑ 7: 10.3x ← 8: 10.1 ← 9: 10.3x ← 10: 9.3 ↗ <hr/> Series 99.7 99.7	60 Shots 	11: 9.3 ↑ 12: 8.9 → 13: 10.8x ↑ 14: 9.8 → 15: 10.4x → 16: 8.6 → 17: 9.0 ↗ 18: 10.1 ↑ 19: 10.7x → 20: 10.0 → <hr/> Series 97.6 197.3
60 Shots 	21: 10.3x → 22: 8.9 → 23: 10.2x → 24: 10.4x ↗ 25: 10.3x → 26: 9.1 ← 27: 9.8 ↗ 28: 10.5x ↘ 29: 10.2x ↗ 30: 10.1 ↑ <hr/> Series 99.8 297.1	60 Shots 	31: 7.8 ← 32: 9.5 ← 33: 10.5x → 34: 10.7x → 35: 10.3x ↗ 36: 10.3x ↓ 37: 8.6 → 38: 9.4 → 39: 9.6 → 40: 10.7x ↑ <hr/> Series 97.4 394.5
60 Shots 	41: 9.5 ← 42: 9.4 ← 43: 9.4 ← 44: 9.8 ↑ 45: 9.1 → 46: 10.0 ↗ 47: 10.6x ← 48: 10.0 → 49: 10.2x ← 50: 10.8x → <hr/> Series 98.8 493.3	60 Shots 	51: 10.8x ↑ 52: 10.0 ↘ 53: 10.3x ← 54: 10.0 ↘ 55: 8.8 ← 56: 10.6x ↑ 57: 10.1 ↗ 58: 9.3 → 59: 9.7 → 60: 10.2x ↑ <hr/> Series 99.8 593.1

Comment	Signature		
---------	-----------	--	--

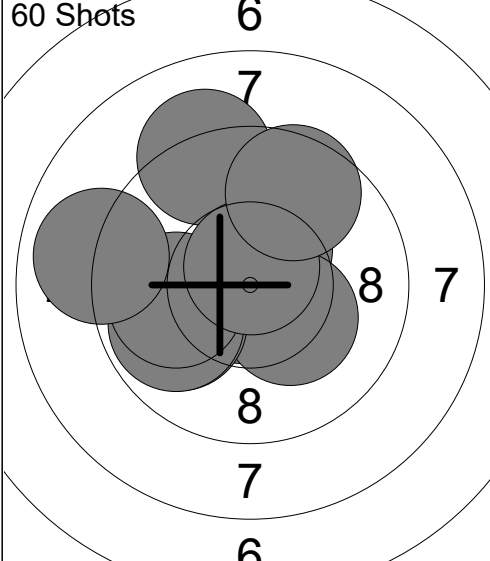
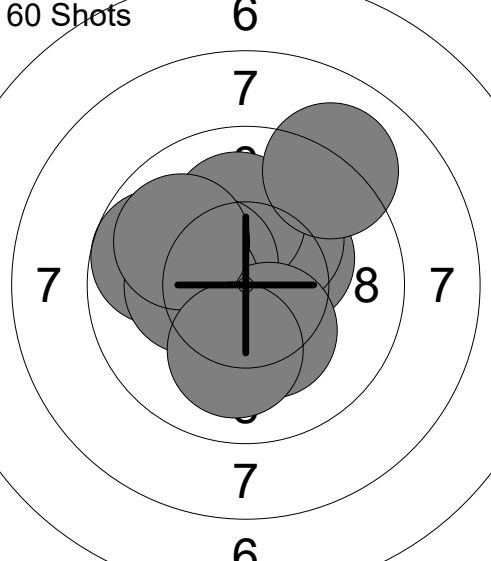
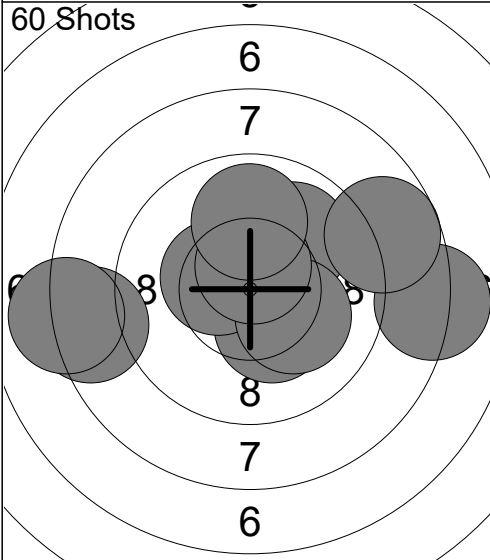
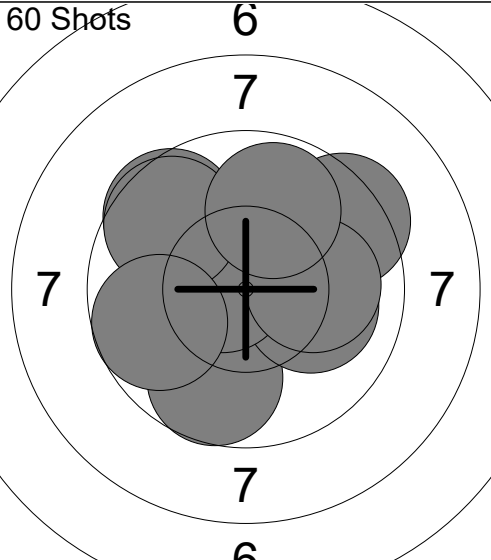
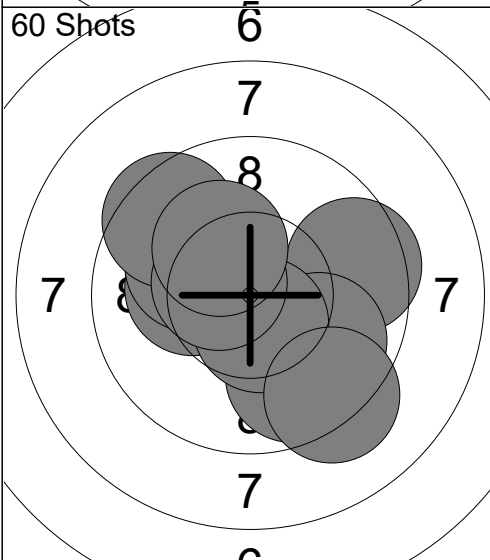
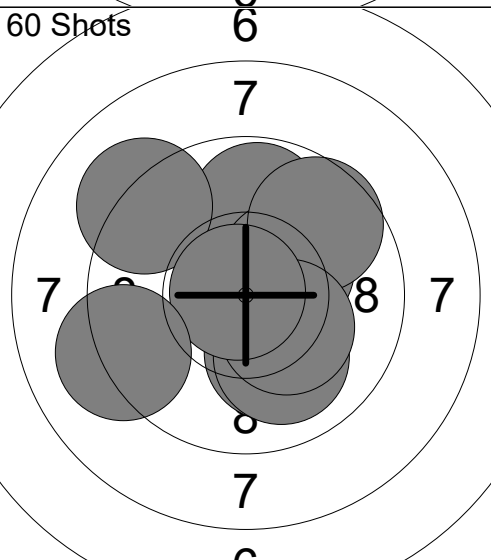
<p>60 Shots</p>  <p style="text-align: center;">6 7 8 7 8 7</p>	<p>1: 10.4x ↗ 2: 10.8x ↘ 3: 10.3x ↘ 4: 9.9 ← 5: 9.8 ← 6: 9.2 ↗ 7: 10.0 ← 8: 10.7x ↗ 9: 9.6 ↗ 10: 8.9 ←</p> <p>Series 99.6 99.6</p>	<p>60 Shots</p>  <p style="text-align: center;">6 7 8 7 7</p>	<p>11: 9.7 ← 12: 10.3x ↗ 13: 10.2x ↗ 14: 10.1 ↗ 15: 9.1 ↗ 16: 10.4x ↖ 17: 10.2x ← 18: 10.3x ↘ 19: 9.9 ↖ 20: 10.1 ↘</p> <p>Series 100.3 199.9</p>
<p>60 Shots</p>  <p style="text-align: center;">6 7 8 7 6</p>	<p>21: 9.9 ↗ 22: 10.3x ↘ 23: 10.4x ← 24: 10.2x ↘ 25: 8.1 → 26: 8.4 ← 27: 10.6x ↗ 28: 8.1 ← 29: 8.7 → 30: 9.9 ↗</p> <p>Series 94.6 294.5</p>	<p>60 Shots</p>  <p style="text-align: center;">6 7 7 7</p>	<p>31: 9.7 ↘ 32: 10.2x ↖ 33: 10.1 → 34: 10.6x ← 35: 9.6 ↖ 36: 9.4 ↗ 37: 9.6 ↖ 38: 9.7 ← 39: 10.1 → 40: 9.9 ↗</p> <p>Series 98.9 393.4</p>
<p>60 Shots</p>  <p style="text-align: center;">6 7 8 7 6</p>	<p>41: 9.7 ↘ 42: 9.5 → 43: 10.2x ← 44: 10.1 ↖ 45: 9.9 ↘ 46: 10.5x ↘ 47: 9.5 ↗ 48: 10.5x ↖ 49: 9.2 ↘ 50: 10.2x ↗</p> <p>Series 99.3 492.7</p>	<p>60 Shots</p>  <p style="text-align: center;">6 7 8 7 7 6</p>	<p>51: 10.4x ↗ 52: 9.8 ↗ 53: 10.3x ↗ 54: 9.2 ↖ 55: 10.1 ↘ 56: 9.6 ↗ 57: 10.0 ↘ 58: 10.3x ↘ 59: 10.8x ↖ 60: 9.2 ←</p> <p>Series 99.7 592.4</p>

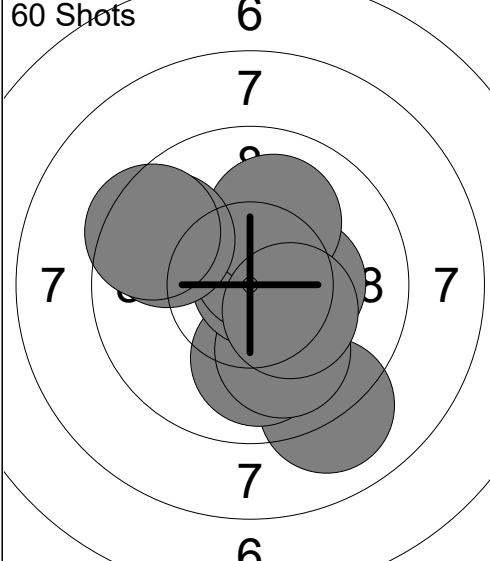
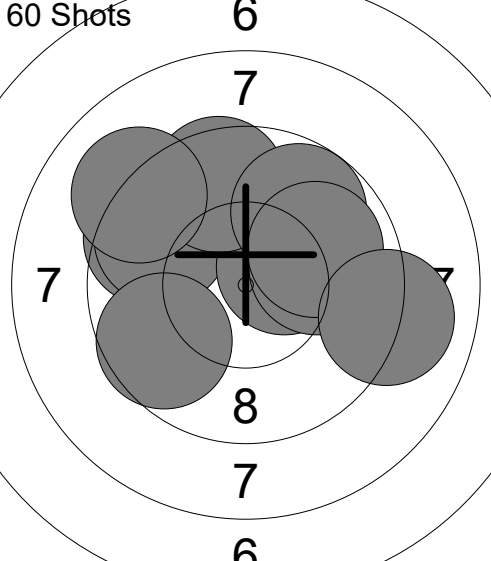
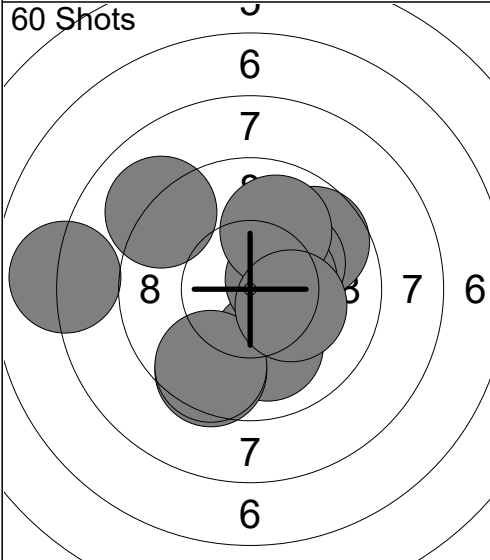
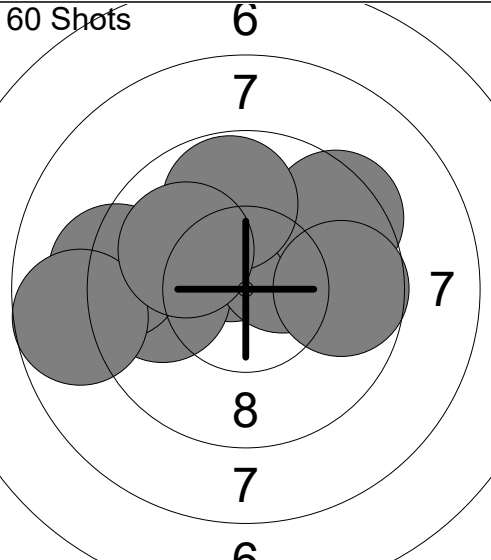
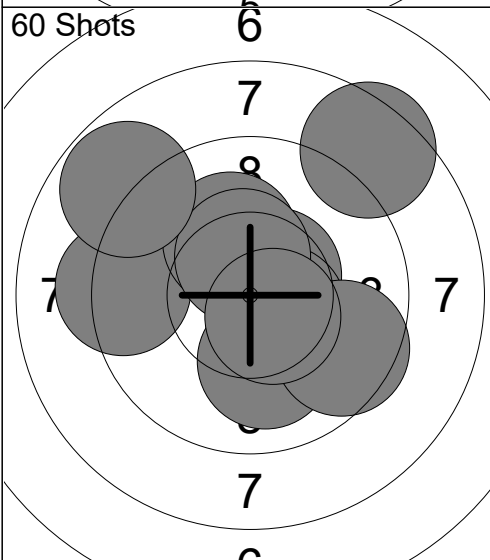
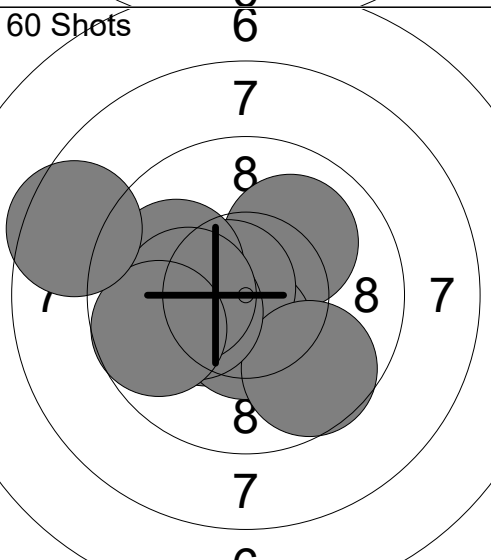
<p>60 Shots</p>  <p style="text-align: center;">6 7 8 7 7</p>	<p>1: 9.1 ↘ 2: 10.0 ↓ 3: 10.0 ↓ 4: 10.3x → 5: 10.8x ↗ 6: 10.7x ↗ 7: 10.1 ↑ 8: 9.7 ↖ 9: 9.5 ↖ 10: 10.3x ↘</p> <p>Series 100.5</p> <p style="text-align: center;">100.5</p>	<p>60 Shots</p>  <p style="text-align: center;">6 7 8 7</p>	<p>11: 9.6 ↖ 12: 9.7 ↖ 13: 10.4x ↗ 14: 9.6 ↑ 15: 9.1 ↖ 16: 10.0 → 17: 9.7 ↗ 18: 9.9 ↗ 19: 9.6 ↖ 20: 9.0 →</p> <p>Series 96.6</p> <p style="text-align: center;">197.1</p>
<p>60 Shots</p>  <p style="text-align: center;">6 6 7 8 7 6</p>	<p>21: 9.7 ↗ 22: 10.2x ↗ 23: 10.0 ↓ 24: 9.5 ↓ 25: 9.6 ↓ 26: 10.4x → 27: 9.1 ↗ 28: 9.9 ↑ 29: 8.0 ← 30: 10.2x →</p> <p>Series 96.6</p> <p style="text-align: center;">293.7</p>	<p>60 Shots</p>  <p style="text-align: center;">6 7 8 7</p>	<p>31: 10.4x ↗ 32: 9.8 ← 33: 9.2 ← 34: 10.2x ↗ 35: 10.4x ↗ 36: 8.7 ← 37: 9.4 ↗ 38: 9.7 → 39: 9.8 ↑ 40: 10.0 ↖</p> <p>Series 97.6</p> <p style="text-align: center;">391.3</p>
<p>60 Shots</p>  <p style="text-align: center;">6 7 8 7 7 6</p>	<p>41: 9.3 ← 42: 10.5x ↗ 43: 10.2x ↗ 44: 10.1 ↓ 45: 10.5x ↘ 46: 10.4x ↗ 47: 8.5 ↗ 48: 9.5 ↘ 49: 8.8 ↗ 50: 10.5x ↘</p> <p>Series 98.3</p> <p style="text-align: center;">489.6</p>	<p>60 Shots</p>  <p style="text-align: center;">6 7 8 8 7 6</p>	<p>51: 10.3x ↖ 52: 10.0 ↗ 53: 10.5x ↓ 54: 10.7x ↖ 55: 9.7 ↘ 56: 10.2x ↖ 57: 10.0 ↖ 58: 10.2x ↖ 59: 9.7 ↖ 60: 8.5 ↖</p> <p>Series 99.8</p> <p style="text-align: center;">589.4</p>

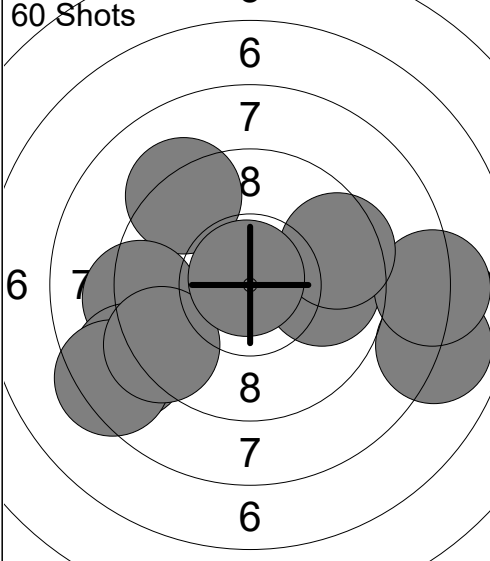
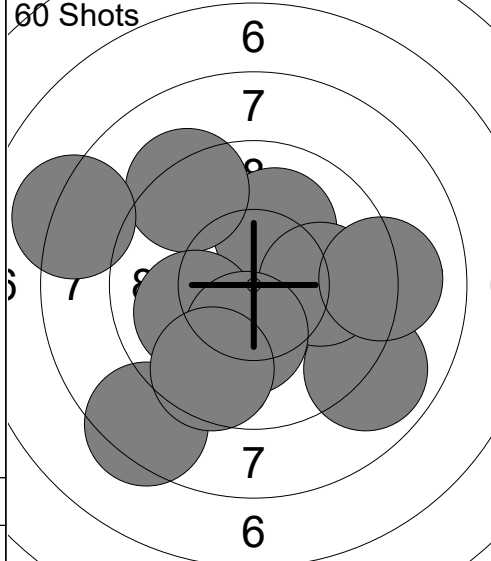
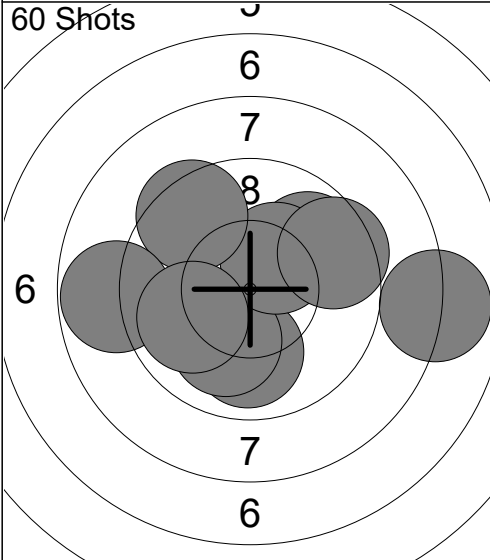
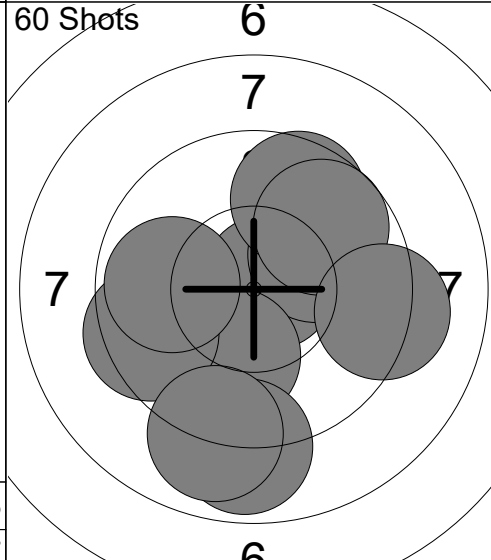
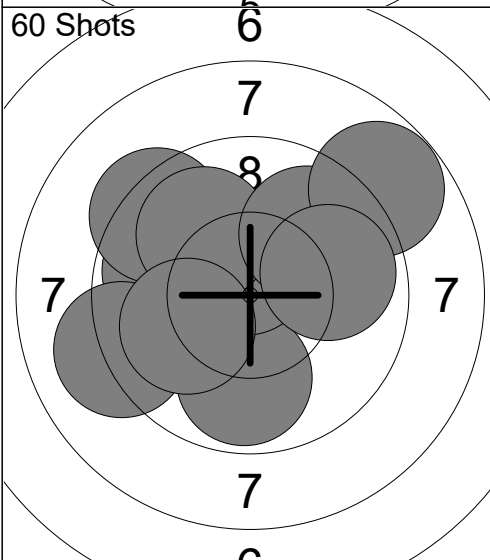
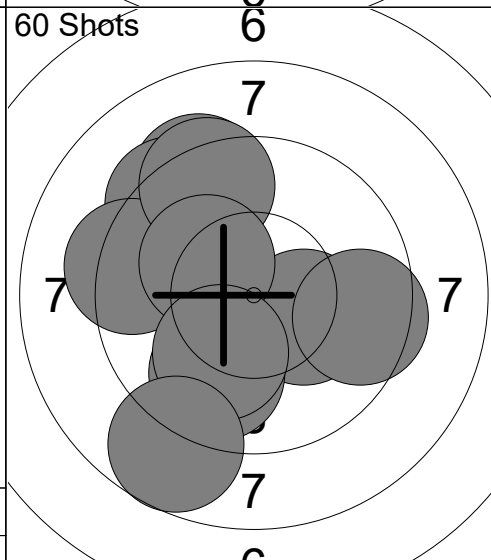
<p>60 Shots</p> 	<p>1: 9.2 ↗ 2: 9.2 ← 3: 8.0 → 4: 8.8 ← 5: 8.4 ← 6: 9.8 → 7: 8.1 → 8: 9.5 → 9: 9.3 ← 10: 10.8x ↗</p> <p>Series 91.1 91.1</p>	<p>60 Shots</p> 	<p>11: 10.1 ↗ 12: 9.3 ↗ 13: 8.9 ↘ 14: 10.0 → 15: 10.0 ← 16: 9.1 → 17: 10.2x ↓ 18: 8.4 ↓ 19: 9.6 ↓ 20: 8.2 ←</p> <p>Series 93.8 184.9</p>
<p>60 Shots</p> 	<p>21: 10.1 ↓ 22: 8.0 → 23: 9.9 ↓ 24: 10.0 ↓ 25: 9.8 ↗ 26: 10.3x ↗ 27: 9.5 ↗ 28: 9.5 → 29: 8.8 ← 30: 9.9 ←</p> <p>Series 95.8 280.7</p>	<p>60 Shots</p> 	<p>31: 10.7x ↗ 32: 10.0 ↗ 33: 10.0 ↓ 34: 9.6 ↗ 35: 9.5 ← 36: 9.7 ↗ 37: 8.9 ↓ 38: 9.2 → 39: 9.9 ← 40: 9.0 ↓</p> <p>Series 96.5 377.2</p>
<p>60 Shots</p> 	<p>41: 9.9 ↓ 42: 9.8 ← 43: 9.1 ← 44: 10.6x ↑ 45: 9.3 ↗ 46: 9.9 ↗ 47: 10.0 ← 48: 9.8 ↗ 49: 8.8 ↗ 50: 9.9 →</p> <p>Series 97.1 474.3</p>	<p>60 Shots</p> 	<p>51: 9.3 ↗ 52: 10.2x → 53: 9.5 → 54: 9.8 ↓ 55: 9.3 ↗ 56: 9.3 ← 57: 9.4 ↗ 58: 10.2x ↗ 59: 10.1 ↓ 60: 8.7 ↓</p> <p>Series 95.8 570.1</p>

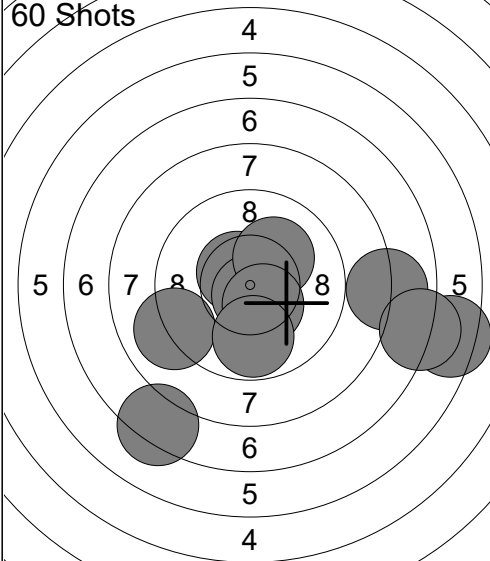
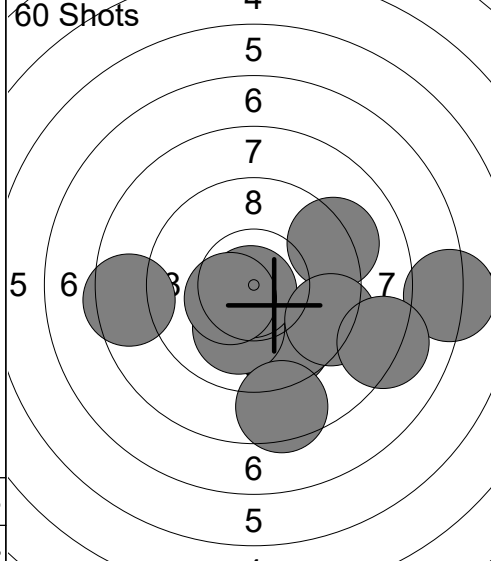
60 Shots 	1: 10.6x ↗ 2: 10.7x ↓ 3: 7.9 → 4: 9.0 ← 5: 6.4 → 6: 7.1 → 7: 10.2x ↗ 8: 10.4x ↓ 9: 7.3 ↓ 10: 9.8 ↓ Series 89.4 89.4	60 Shots 	11: 9.7 ↓ 12: 10.1 ↓ 13: 9.2 → 14: 10.8x ↓ 15: 8.5 ↓ 16: 7.1 → 17: 8.5 ← 18: 9.3 → 19: 8.2 → 20: 10.4x ← Series 91.8 181.2
--	--	--	---

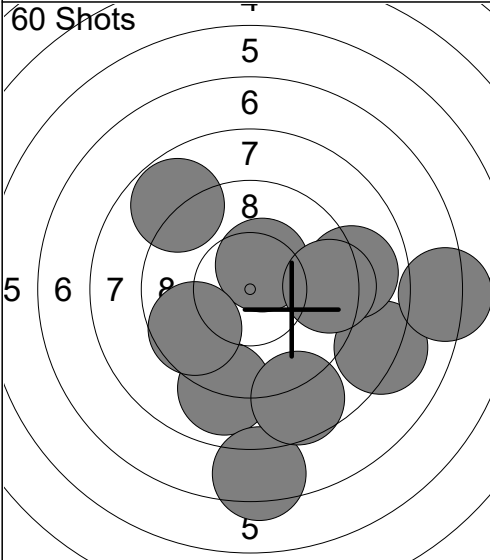
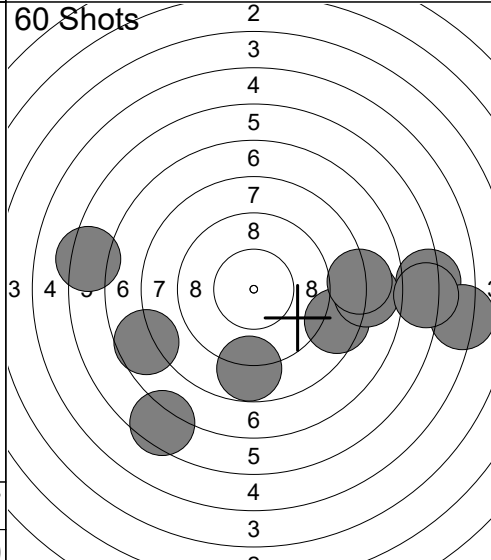
60 Shots 	21: 10.4x ↗ 22: 8.2 → 23: 9.0 → 24: 9.0 ↓ 25: 7.2 → 26: 9.4 → 27: 7.4 ↓ 28: 8.7 ↓ 29: 8.8 ↗ 30: 9.6 ← Series 87.7 268.9	60 Shots 	31: 6.5 ↓ 32: 6.1 → 33: 8.8 ↓ 34: 8.5 → 35: 7.8 → 36: 8.0 → 37: 7.7 ← 38: 6.3 ← 39: 5.1 → 40: 6.2 → Series 71.0 339.9
---	--	---	--

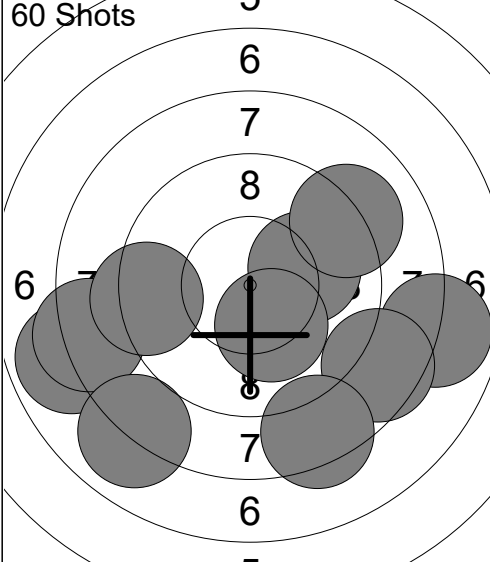
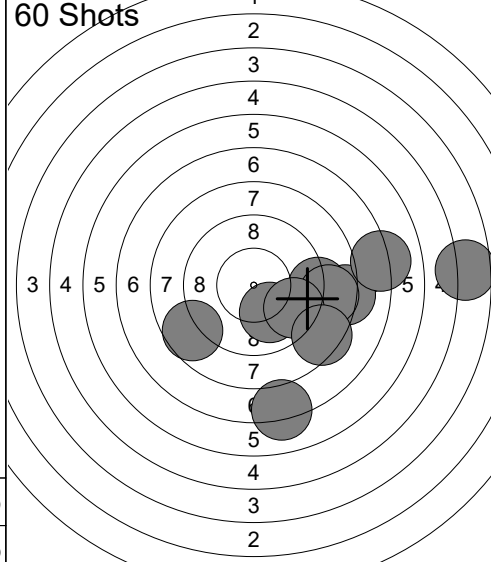
60 Shots 	41: 7.9 → 42: 7.9 ← 43: 10.0 → 44: 8.3 ← 45: 9.1 ↗ 46: 8.5 → 47: 8.4 ↓ 48: 10.2x ↓ 49: 9.3 ← 50: 8.0 ↓ Series 87.6 427.5	60 Shots 	51: 8.2 → 52: 10.0 ↓ 53: 8.7 ← 54: 9.0 → 55: 7.1 ↓ 56: 8.7 → 57: 4.6 → 58: 7.1 → 59: 9.6 ↓ 60: 8.4 ↓ Series 81.4 508.9
--	---	--	---

<p>60 Shots</p>	<p>1: 9.4 ←</p> <p>2: 9.8 ←</p> <p>3: 10.5x →</p> <p>4: 10.1 ←</p> <p>5: 9.5 ←</p> <p>6: 10.4x ↓</p> <p>7: 10.6x ↓</p> <p>8: 10.3x ↗</p> <p>9: 10.4x ↘</p> <p>10: 10.5x →</p> <hr/> <p>Series 101.5</p> <p style="text-align: center;">101.5</p>	<p>60 Shots</p>	<p>11: 10.4x ↗</p> <p>12: 9.9 →</p> <p>13: 10.3x ↓</p> <p>14: 10.7x ←</p> <p>15: 9.5 ←</p> <p>16: 10.6x ↑</p> <p>17: 10.4x ←</p> <p>18: 10.4x ←</p> <p>19: 9.7 ↑</p> <p>20: 10.8x →</p> <hr/> <p>Series 102.7</p> <p style="text-align: center;">204.2</p>
<p>60 Shots</p>	<p>21: 10.6x ←</p> <p>22: 9.0 ←</p> <p>23: 10.3x ↗</p> <p>24: 10.2x ↑</p> <p>25: 10.1 ↑</p> <p>26: 10.1 ←</p> <p>27: 10.4x ↓</p> <p>28: 10.2x ←</p> <p>29: 10.2x ↓</p> <p>30: 10.0 ↑</p> <hr/> <p>Series 101.1</p> <p style="text-align: center;">305.3</p>	<p>60 Shots</p>	<p>31: 10.6x ↑</p> <p>32: 10.1 ↑</p> <p>33: 10.2x ↑</p> <p>34: 10.3x →</p> <p>35: 10.1 ↓</p> <p>36: 10.1 ↓</p> <p>37: 10.8x ↓</p> <p>38: 9.8 ↑</p> <p>39: 10.3x →</p> <p>40: 10.5x ↓</p> <hr/> <p>Series 102.8</p> <p style="text-align: center;">408.1</p>
<p>60 Shots</p>	<p>41: 10.6x ↑</p> <p>42: 10.5x ←</p> <p>43: 10.5x →</p> <p>44: 10.2x ←</p> <p>45: 10.1 ↓</p> <p>46: 9.9 ↑</p> <p>47: 10.6x ↓</p> <p>48: 9.8 ↓</p> <p>49: 10.4x ←</p> <p>50: 10.8x ↓</p> <hr/> <p>Series 103.4</p> <p style="text-align: center;">511.5</p>	<p>60 Shots</p>	<p>51: 10.2x ←</p> <p>52: 10.4x ↑</p> <p>53: 10.3x →</p> <p>54: 10.6x ↓</p> <p>55: 10.6x ↓</p> <p>56: 10.5x ↗</p> <p>57: 10.5x ↑</p> <p>58: 9.8 →</p> <p>59: 10.8x ←</p> <p>60: 10.1 ↓</p> <hr/> <p>Series 103.8</p> <p style="text-align: center;">615.3</p>

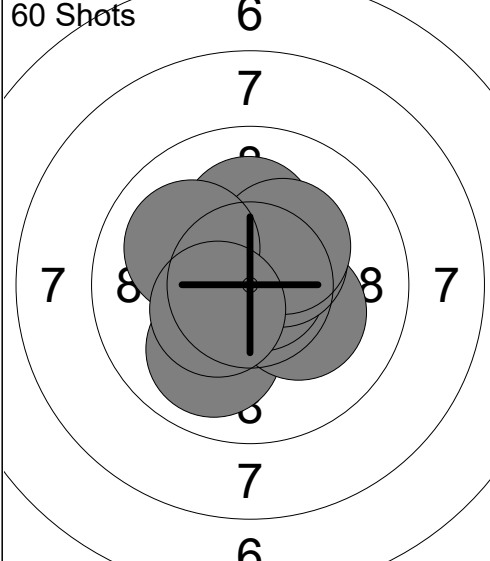
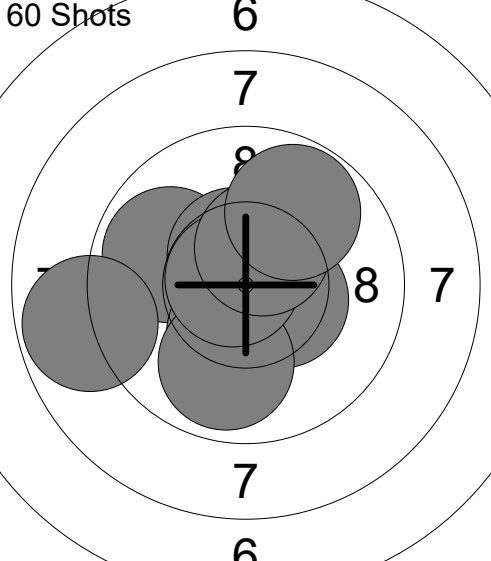
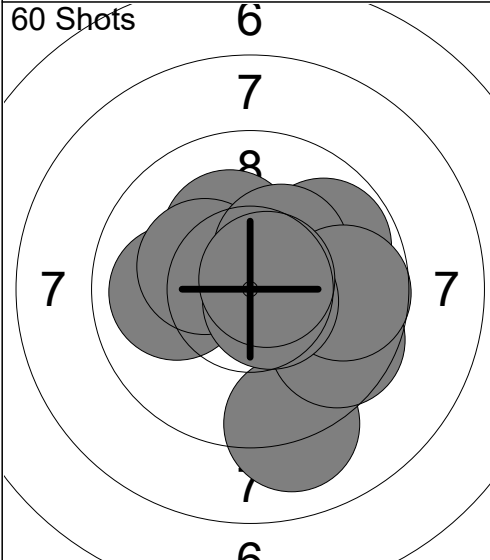
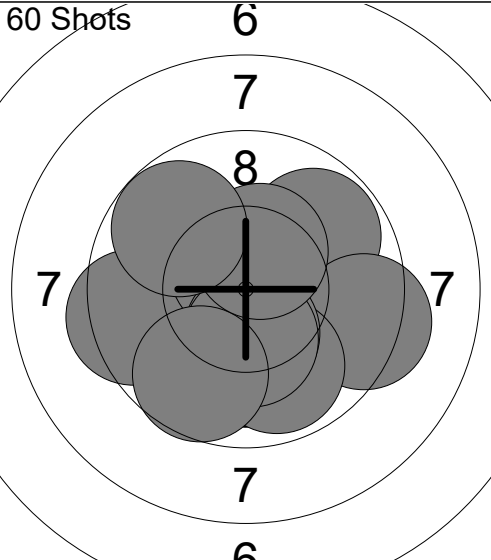
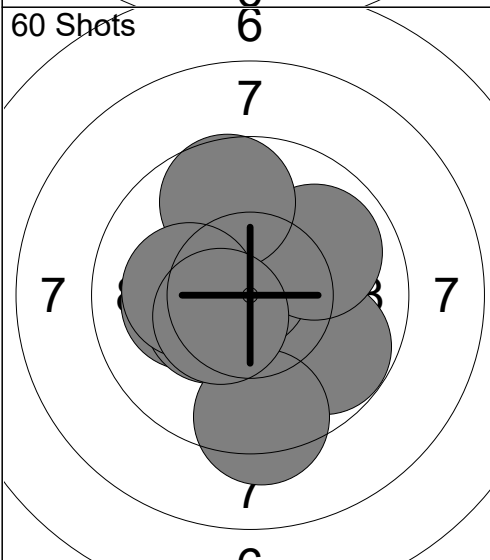
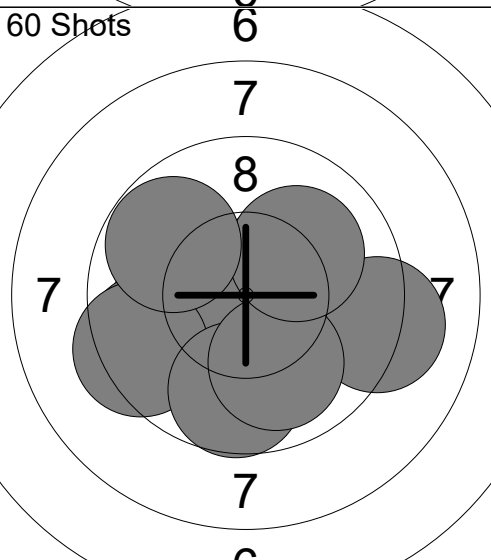
<p>60 Shots</p>  <p style="text-align: center;">6 7 8 7</p> <p style="text-align: center;">7 8 8 7</p> <p style="text-align: center;">7</p> <p style="text-align: center;">6 7</p>	<p>1: 10.0 ↘ 2: 10.6x ↗ 3: 10.1 ↑ 4: 10.2x ➤ 5: 10.8x ↗ 6: 10.8x ➤ 7: 10.4x ↗ 8: 10.3x ↗ 9: 10.0 ↖ 10: 10.4x ↖</p> <p>Series 103.6</p> <p style="text-align: center;">103.6</p>	<p>60 Shots</p>  <p style="text-align: center;">6 7 8 7</p> <p style="text-align: center;">7 8 7</p> <p style="text-align: center;">7</p> <p style="text-align: center;">6 7</p>	<p>11: 10.3x ↖ 12: 9.9 ↖ 13: 10.5x ↑ 14: 10.3x ↓ 15: 10.4x ➤ 16: 9.9 ↓ 17: 10.8x ↖ 18: 10.4x ↑ 19: 8.8 ← 20: 9.8 ↗</p> <p>Series 101.1</p> <p style="text-align: center;">204.7</p>
<p>60 Shots</p>  <p style="text-align: center;">6 7 8 7</p> <p style="text-align: center;">7 7</p> <p style="text-align: center;">7</p> <p style="text-align: center;">6 7</p>	<p>21: 10.0 ← 22: 9.8 ↗ 23: 10.2x ↑ 24: 10.3x ↖ 25: 9.1 ↓ 26: 9.6 ➤ 27: 10.3x ↗ 28: 9.7 ➤ 29: 10.6x ➤ 30: 10.7x ↗</p> <p>Series 100.3</p> <p style="text-align: center;">305.0</p>	<p>60 Shots</p>  <p style="text-align: center;">6 7 8 7</p> <p style="text-align: center;">7 7</p> <p style="text-align: center;">7</p> <p style="text-align: center;">6 7</p>	<p>31: 9.8 ↗ 32: 9.4 ← 33: 9.3 ➤ 34: 9.9 ↓ 35: 10.7x ↑ 36: 10.4x ↓ 37: 10.3x ↓ 38: 9.7 ↓ 39: 10.4x ↑ 40: 9.8 ↖</p> <p>Series 99.7</p> <p style="text-align: center;">404.7</p>
<p>60 Shots</p>  <p style="text-align: center;">6 7 8 7</p> <p style="text-align: center;">7 7</p> <p style="text-align: center;">7</p> <p style="text-align: center;">6 7</p>	<p>41: 10.1 ← 42: 10.8x ↖ 43: 9.8 ➤ 44: 10.8x ↗ 45: 9.9 ↗ 46: 9.7 ↑ 47: 10.4x ↖ 48: 10.1 ← 49: 9.3 ↓ 50: 10.5x ↖</p> <p>Series 101.4</p> <p style="text-align: center;">506.1</p>	<p>60 Shots</p>  <p style="text-align: center;">6 7 8 7</p> <p style="text-align: center;">7 7</p> <p style="text-align: center;">7</p> <p style="text-align: center;">6 7</p>	<p>51: 10.4x ↗ 52: 10.4x ↖ 53: 9.6 ← 54: 10.4x ← 55: 9.4 ← 56: 9.2 ➤ 57: 9.7 ↓ 58: 10.0 ↓ 59: 10.1 ↗ 60: 9.8 ↖</p> <p>Series 99.0</p> <p style="text-align: center;">605.1</p>

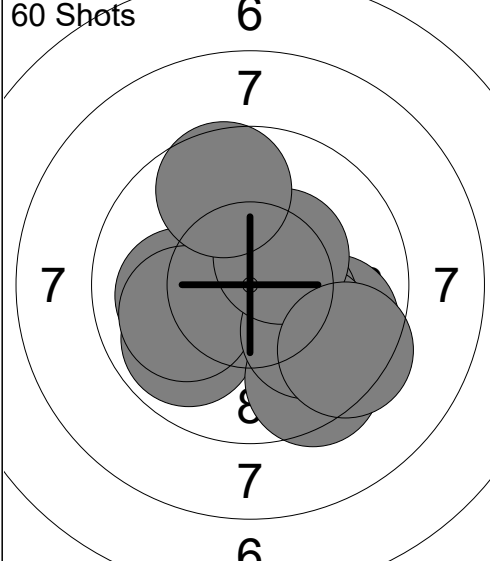
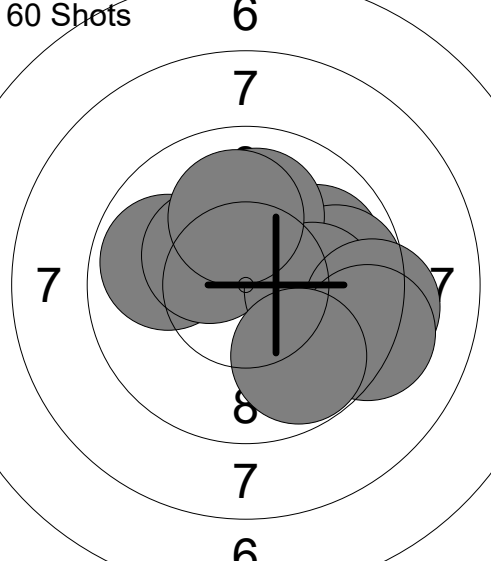
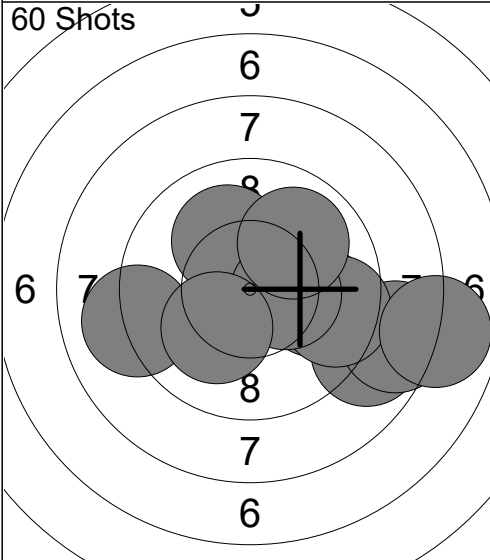
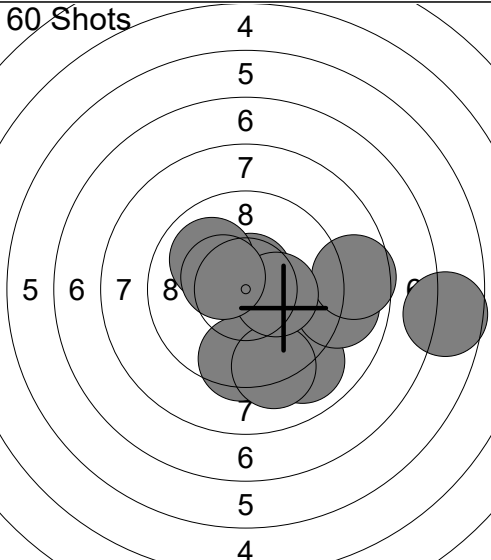
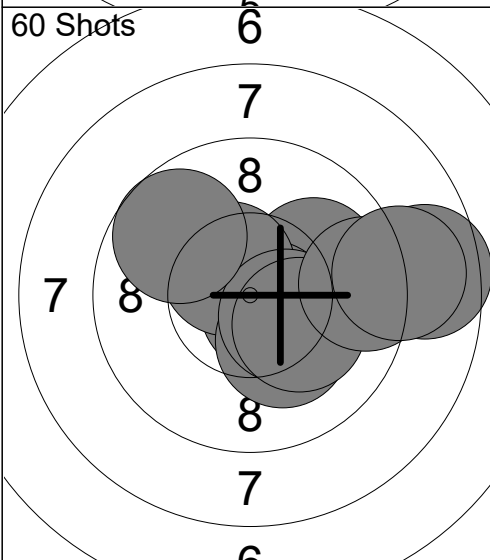
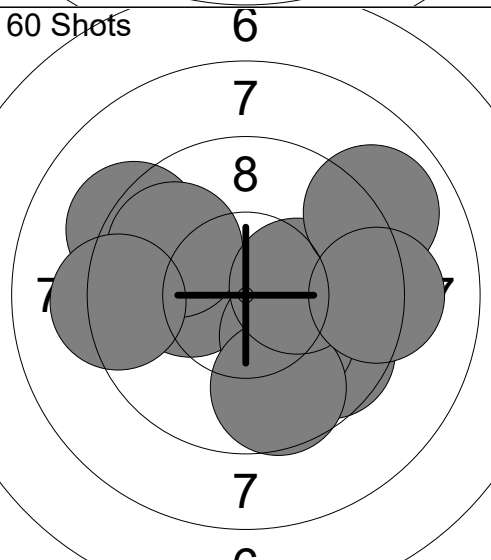
<p>60 Shots</p> 	<p>1: 9.8 ➤ 2: 10.4x ➤ 3: 10.0 ← 4: 9.9 ↙ 5: 10.0 ← 6: 9.5 ↘ 7: 10.0 ↘ 8: 10.4x ↗ 9: 9.6 ↑ 10: 9.4 ↘</p> <p>Series 99.0 99.0</p>	<p>60 Shots</p> 	<p>11: 9.9 ➤ 12: 9.9 ← 13: 10.3x ↖ 14: 9.8 ➤ 15: 10.0 ↑ 16: 10.1 ➤ 17: 9.3 ➤ 18: 10.0 ↑ 19: 9.2 ➤ 20: 9.8 ↘</p> <p>Series 98.3 197.3</p>
<p>60 Shots</p> 	<p>21: 9.1 ← 22: 9.9 ➤ 23: 8.8 ↘ 24: 8.5 ➤ 25: 9.5 ➤ 26: 7.9 ➤ 27: 10.1 ↗ 28: 10.4x ➤ 29: 10.1 ↙ 30: 9.9 ↗</p> <p>Series 94.2 291.5</p>	<p>60 Shots</p> 	<p>31: 9.0 ↘ 32: 10.6x ↑ 33: 9.0 ➤ 34: 9.5 ↓ 35: 6.7 ➤ 36: 9.2 ↘ 37: 10.0 ↗ 38: 8.6 ➤ 39: 10.3x ➤ 40: 10.4x ↖</p> <p>Series 93.3 384.8</p>
<p>60 Shots</p> 	<p>41: 10.0 ➤ 42: 10.7x ↘ 43: 10.5x ↗ 44: 10.2x ↘ 45: 10.4x ↘ 46: 8.6 ➤ 47: 10.2x ↘ 48: 9.4 ➤ 49: 9.7 ↗ 50: 8.9 ➤</p> <p>Series 98.6 483.4</p>	<p>60 Shots</p> 	<p>51: 9.6 ↘ 52: 9.2 ↖ 53: 10.2x ← 54: 10.2x ↘ 55: 9.7 ↘ 56: 9.8 ↗ 57: 9.3 ← 58: 10.3x ➤ 59: 9.0 ↗ 60: 9.2 ➤</p> <p>Series 96.5 579.9</p>

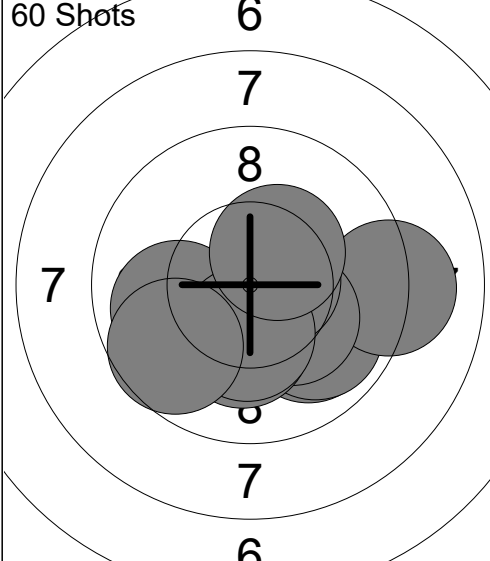
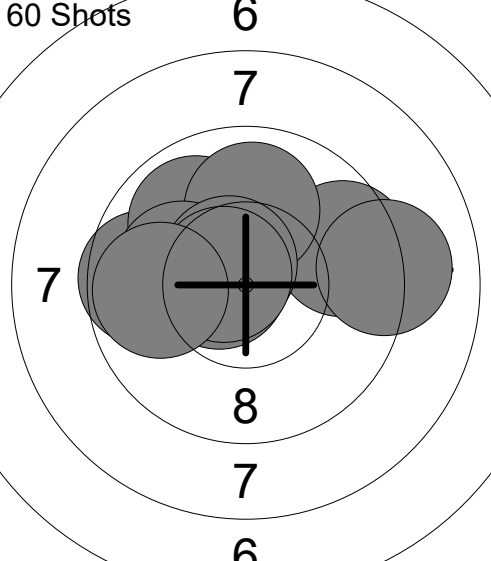
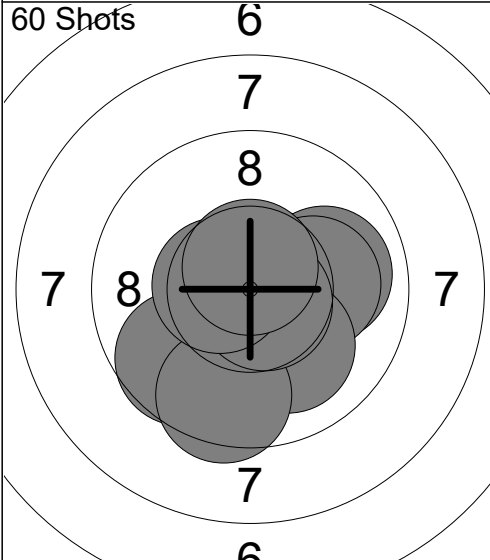
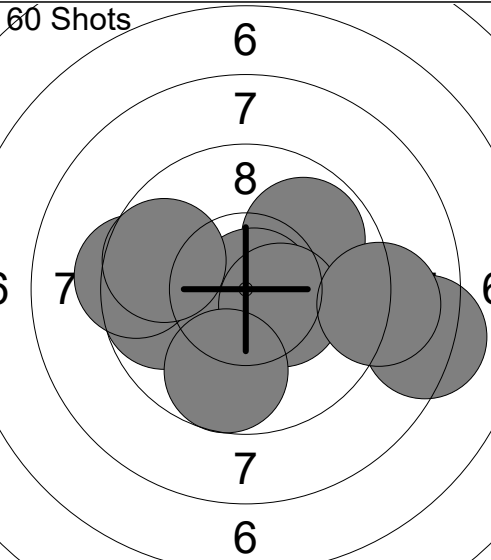
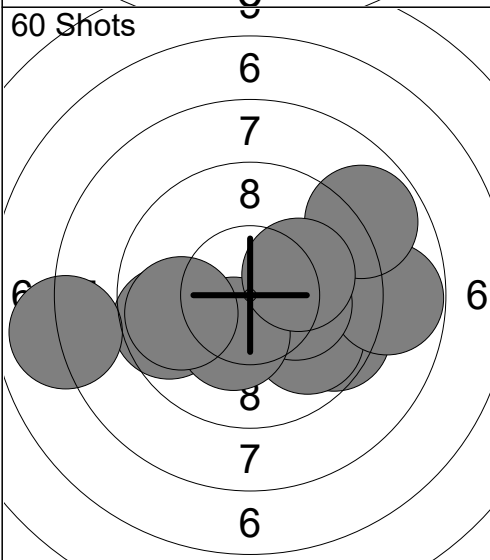
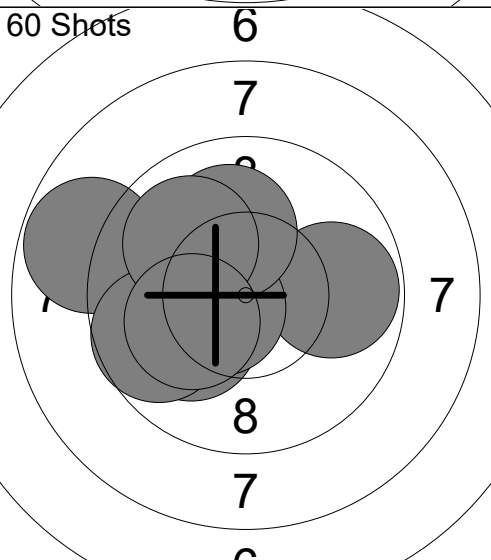
<p>60 Shots</p> 	<p>1: 9.9 ↘ 2: 9.9 ↘ 3: 9.1 → 4: 10.2x ↘ 5: 10.2x ↓ 6: 10.6x → 7: 10.0 ← 8: 10.3x ↓ 9: 9.7 ↙ 10: 10.4x ↗</p> <p>Series 100.3 100.3</p>	<p>60 Shots</p> 	<p>11: 9.6 ← 12: 9.6 → 13: 9.9 ↗ 14: 10.6x ← 15: 10.0 ↑ 16: 10.1 ← 17: 10.6x ↗ 18: 10.6x ↖ 19: 9.1 → 20: 9.8 ←</p> <p>Series 99.9 200.2</p>
<p>60 Shots</p> 	<p>21: 10.5x → 22: 10.6x → 23: 10.0 → 24: 9.7 ↙ 25: 10.1 → 26: 10.1 ↘ 27: 9.5 ↘ 28: 10.7x ↘ 29: 10.5x ← 30: 10.7x ↑</p> <p>Series 102.4 302.6</p>	<p>60 Shots</p> 	<p>31: 10.8x ↓ 32: 9.8 ↗ 33: 10.8x → 34: 9.7 ← 35: 9.4 ← 36: 8.3 → 37: 10.4x → 38: 9.0 → 39: 9.7 ↓ 40: 9.7 ←</p> <p>Series 97.6 400.2</p>
<p>60 Shots</p> 	<p>41: 9.6 ← 42: 9.5 → 43: 9.8 ↘ 44: 8.8 → 45: 10.2x → 46: 8.8 ↗ 47: 10.3x ↓ 48: 9.8 ← 49: 10.1 → 50: 8.0 ←</p> <p>Series 94.9 495.1</p>	<p>60 Shots</p> 	<p>51: 10.1 ↙ 52: 10.0 ← 53: 10.3x ↖ 54: 9.8 → 55: 8.8 ← 56: 9.7 ← 57: 10.5x ↖ 58: 10.1 ↑ 59: 10.0 ↖ 60: 10.2x ↖</p> <p>Series 99.5 594.6</p>

Relay **5** Lane **30** **LEPPER Adelynn**

1-80 Spokane JRT Precision

31.01.2025 2025 AirNats by X Count Civilian Marksmanship Program

Comment Signature

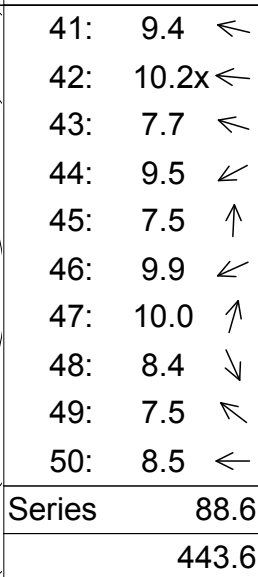
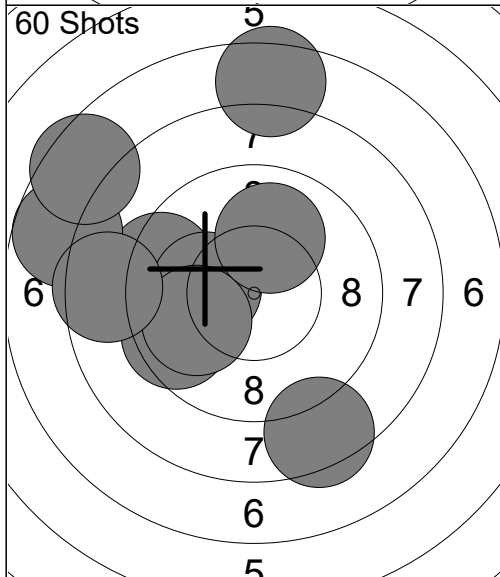
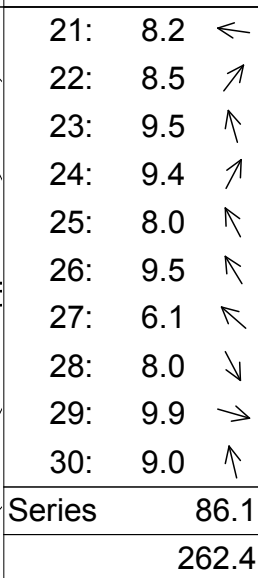
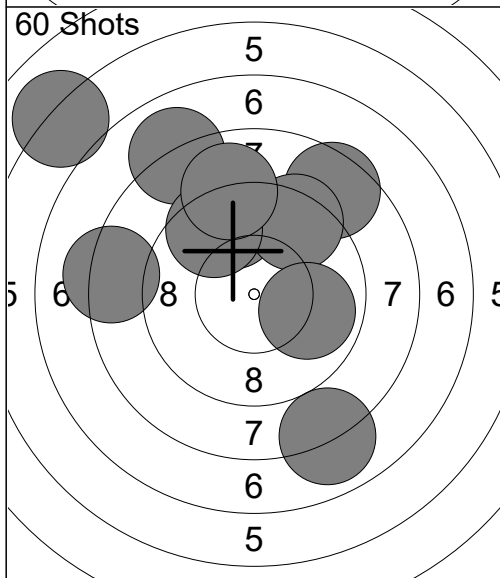
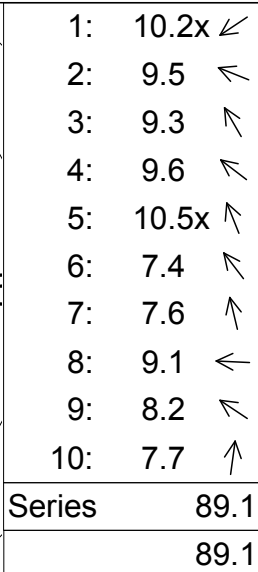
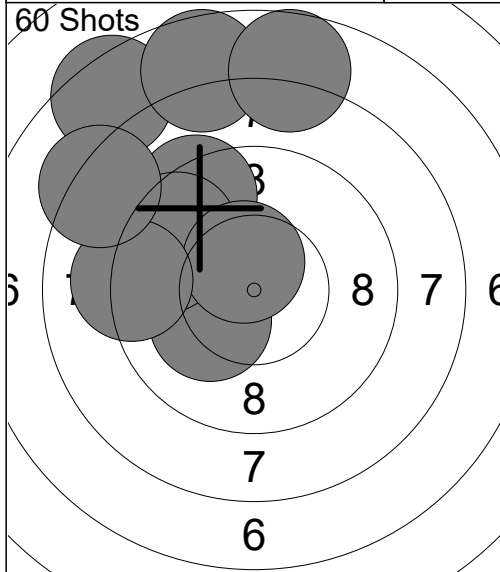

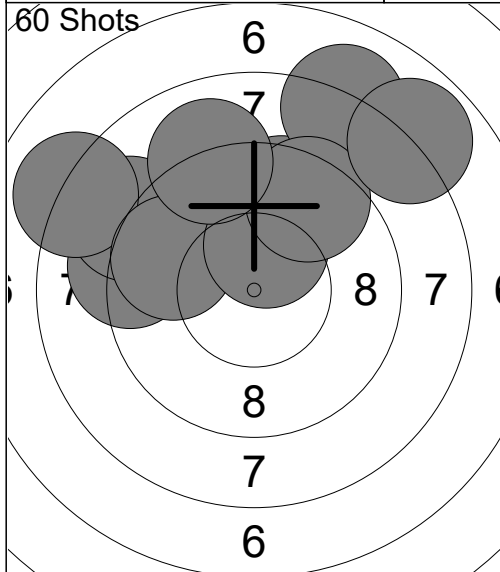

1:	9.1	←
2:	8.9	↖
3:	8.1	↖
4:	9.7	↖
5:	9.6	↑
6:	10.3x	↑
7:	8.1	↑
8:	9.4	↗
9:	9.0	↑
10:	7.9	↗
Series	90.1	
	90.1	

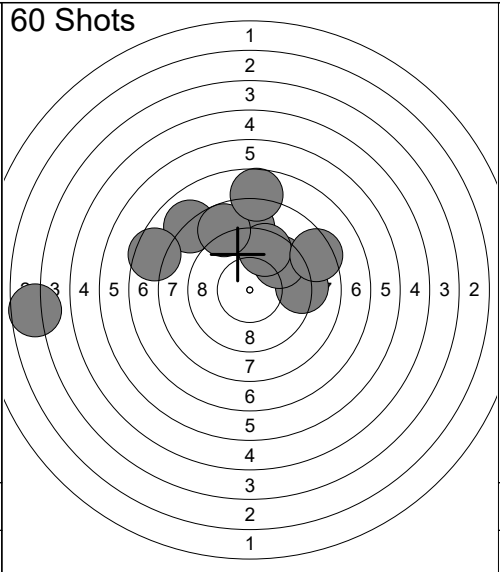

11:	9.2	→
12:	9.6	↗
13:	8.0	↖
14:	3.6	←
15:	8.8	↑
16:	9.5	↑
17:	8.8	↑
18:	7.7	↑
19:	8.4	↗
20:	7.5	←
Series	81.1	
	171.2	

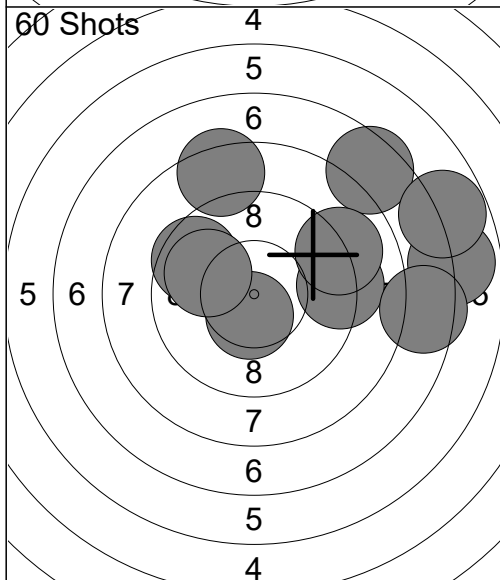

21:	6.9	→
22:	8.4	↑
23:	10.5x	↓
24:	9.2	→
25:	7.5	→
26:	9.6	↖
27:	9.9	↖
28:	7.5	↗
29:	6.8	→
30:	9.0	↗
Series	85.3	
	256.5	

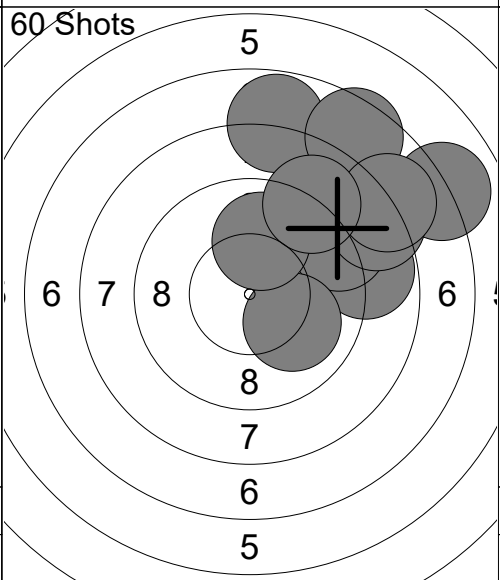

31:	7.0	↗
32:	8.8	→
33:	7.8	↑
34:	9.1	↗
35:	7.5	↗
36:	8.3	↗
37:	10.0	↘
38:	7.9	↗
39:	10.0	↑
40:	9.0	↗
Series	85.4	
	341.9	

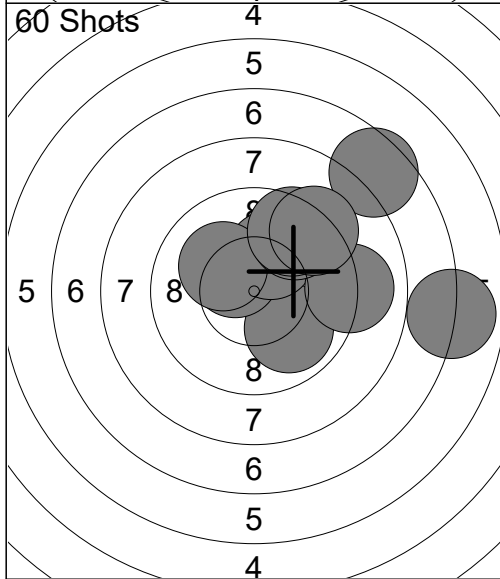

41:	9.9	↘
42:	10.4x	↖
43:	10.1	↑
44:	7.5	↗
45:	10.1	↖
46:	9.0	→
47:	9.5	↗
48:	9.5	↗
49:	6.9	→
50:	9.2	↗
Series	92.1	
	434.0	

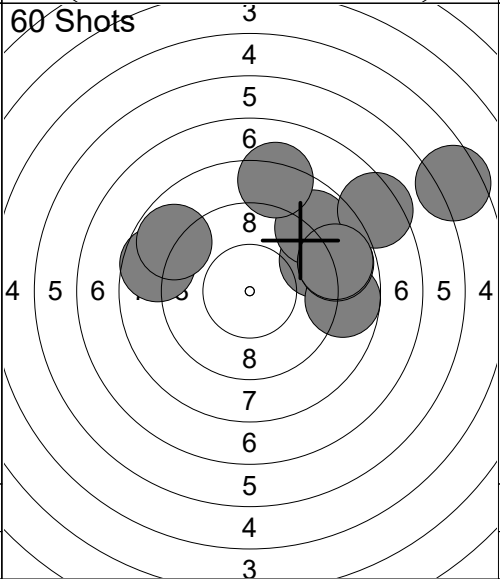

51:	8.7	←
52:	9.2	↗
53:	8.8	↗
54:	8.7	→
55:	8.8	→
56:	7.4	↗
57:	8.8	→
58:	8.3	↑
59:	5.5	↗
60:	8.8	↖
Series	83.0	
	517.0	

<p>60 Shots</p> <p style="text-align: center;">6 7 8 7 8 7 6</p>	<p>1: 10.5x →</p> <p>2: 8.6 ←</p> <p>3: 10.0 →</p> <p>4: 9.1 ↗</p> <p>5: 9.5 ↗</p> <p>6: 9.6 ↗</p> <p>7: 10.1 ↖</p> <p>8: 9.6 ↘</p> <p>9: 9.0 ←</p> <p>10: 7.7 ↘</p> <hr/> <p>Series 93.7</p> <hr/> <p style="text-align: center;">93.7</p>	<p>60 Shots</p> <p style="text-align: center;">6 8 7 6 7 8 7 6</p>	<p>11: 10.0 ↓</p> <p>12: 8.8 ←</p> <p>13: 9.5 →</p> <p>14: 10.6x ↓</p> <p>15: 10.1 ←</p> <p>16: 8.5 ↖</p> <p>17: 9.3 ↗</p> <p>18: 9.3 →</p> <p>19: 8.2 ↑</p> <p>20: 8.6 →</p> <hr/> <p>Series 92.9</p> <hr/> <p style="text-align: center;">186.6</p>
<p>60 Shots</p> <p style="text-align: center;">6 7 8 7 8 7 6</p>	<p>21: 10.1 →</p> <p>22: 10.9x ↑</p> <p>23: 8.8 ↑</p> <p>24: 10.3x →</p> <p>25: 8.8 →</p> <p>26: 8.6 ↗</p> <p>27: 9.2 ↗</p> <p>28: 9.8 ↗</p> <p>29: 9.5 ↘</p> <p>30: 9.7 ↑</p> <hr/> <p>Series 95.7</p> <hr/> <p style="text-align: center;">282.3</p>	<p>60 Shots</p> <p style="text-align: center;">6 7 8 7 6 7 8 6</p>	<p>31: 10.6x ↓</p> <p>32: 8.6 ←</p> <p>33: 10.6x ↘</p> <p>34: 9.4 →</p> <p>35: 9.8 ↓</p> <p>36: 9.8 ↑</p> <p>37: 9.7 ↗</p> <p>38: 9.2 ↘</p> <p>39: 8.6 ↑</p> <p>40: 8.2 ←</p> <hr/> <p>Series 94.5</p> <hr/> <p style="text-align: center;">376.8</p>
<p>60 Shots</p> <p style="text-align: center;">6 7 7 6 7 8 7 6</p>	<p>41: 8.9 →</p> <p>42: 9.0 ←</p> <p>43: 9.3 ↘</p> <p>44: 9.5 →</p> <p>45: 9.4 ↗</p> <p>46: 8.1 ↗</p> <p>47: 9.0 →</p> <p>48: 9.9 ↘</p> <p>49: 9.5 ↑</p> <p>50: 8.9 →</p> <hr/> <p>Series 91.5</p> <hr/> <p style="text-align: center;">468.3</p>	<p>60 Shots</p> <p style="text-align: center;">5 6 7 8 6 7 8 6 5</p>	<p>51: 10.6x ↑</p> <p>52: 9.1 ←</p> <p>53: 8.6 ↘</p> <p>54: 10.1 ←</p> <p>55: 9.7 ↑</p> <p>56: 8.9 ↗</p> <p>57: 8.7 ←</p> <p>58: 7.9 →</p> <p>59: 10.3x ↑</p> <p>60: 10.2x ↗</p> <hr/> <p>Series 94.1</p> <hr/> <p style="text-align: center;">562.4</p>

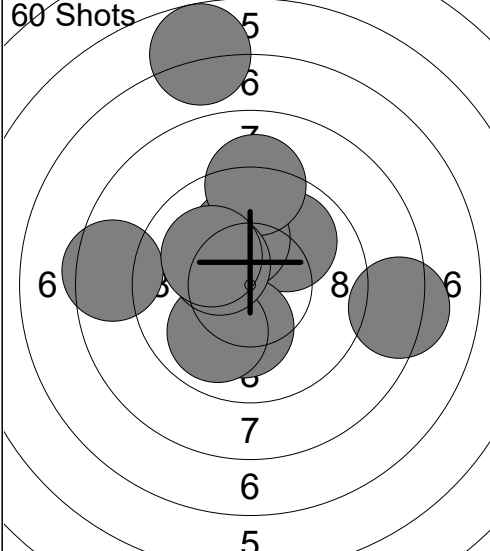
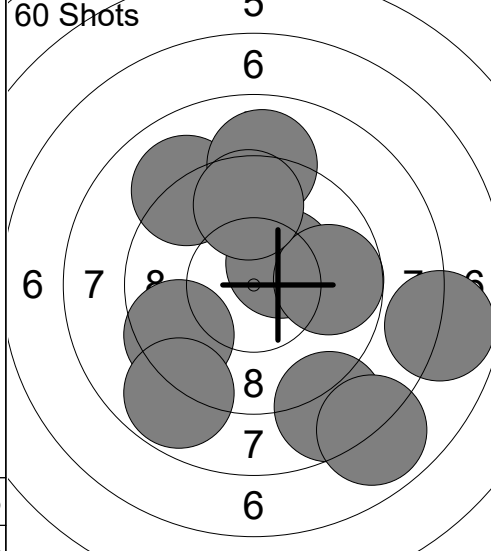
<p>60 Shots</p>  <p style="text-align: center;">5 6 7 8 6 7 6 5</p>	<p>1: 9.9 ↗ 2: 8.5 ← 3: 10.2x ↓ 4: 9.9 ↘ 5: 10.1 ↑ 6: 8.3 → 7: 9.2 ↑ 8: 6.8 ↑ 9: 10.3x ↖ 10: 10.1 ↖</p> <p>Series 93.3 93.3</p>	<p>60 Shots</p>  <p style="text-align: center;">5 6 7 8 7 6 6 5</p>	<p>11: 7.8 → 12: 10.4x ↗ 13: 8.6 ↓ 14: 9.7 → 15: 7.9 ↓ 16: 9.5 ↙ 17: 8.8 ↘ 18: 9.1 ↖ 19: 9.0 ↑ 20: 9.6 ↑</p> <p>Series 90.4 183.7</p>
---	---	---	---

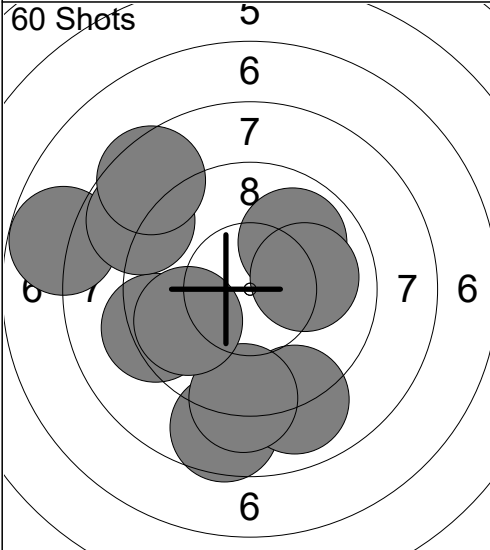
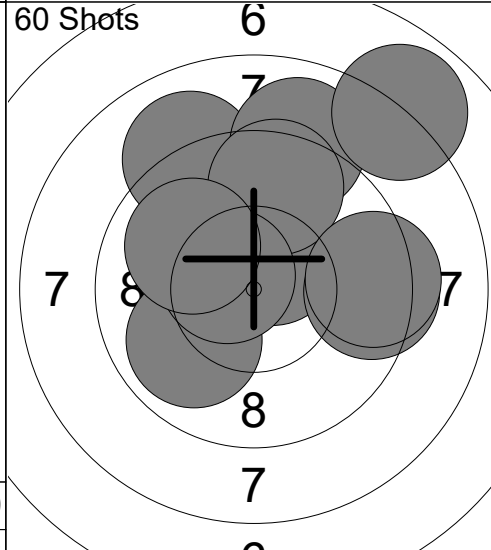
<p>60 Shots</p>  <p style="text-align: center;">5 6 7 8 7 6 6 5</p>	<p>21: 7.8 ← 22: 8.6 ↓ 23: 9.9 ↗ 24: 9.3 ← 25: 9.0 ↓ 26: 10.0 → 27: 9.2 ↓ 28: 8.8 ↗ 29: 8.5 ↗ 30: 9.8 ↙</p> <p>Series 90.9 274.6</p>	<p>60 Shots</p>  <p style="text-align: center;">5 6 7 8 7 7 7 6</p>	<p>31: 9.0 ↑ 32: 10.5x ↗ 33: 9.4 → 34: 9.9 ↙ 35: 9.0 ↑ 36: 9.6 ↑ 37: 9.4 → 38: 10.6x ↖ 39: 7.9 ↗ 40: 10.0 ↖</p> <p>Series 95.3 369.9</p>
--	--	--	--

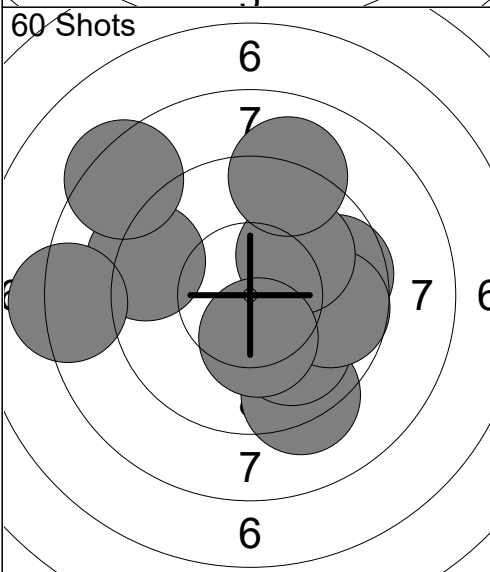
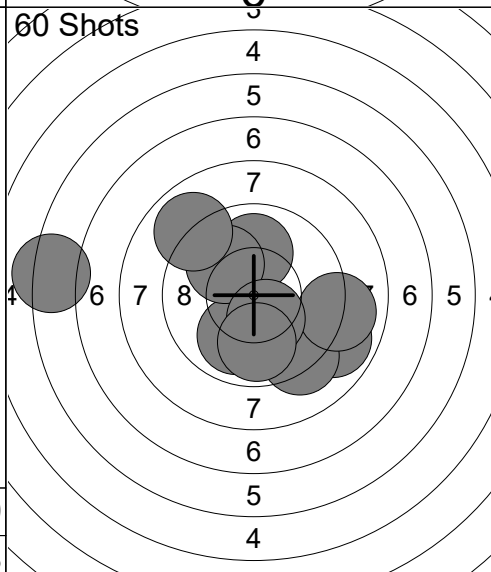
<p>60 Shots</p>  <p style="text-align: center;">5 6 7 8 7 6 7 6</p>	<p>41: 9.3 ← 42: 9.6 → 43: 9.3 ↘ 44: 10.0 ↘ 45: 9.7 → 46: 10.0 ↗ 47: 10.3x ↓ 48: 8.2 ← 49: 8.4 ↗ 50: 9.1 ↑</p> <p>Series 93.9 463.8</p>	<p>60 Shots</p>  <p style="text-align: center;">5 4 5 6 7 8 7 6 5 4 7 6 5 4 6 5 4</p>	<p>51: 10.0 ↓ 52: 10.0 ↑ 53: 10.0 ↗ 54: 8.9 → 55: 6.3 ← 56: 9.2 ↘ 57: 8.9 ↗ 58: 9.0 → 59: 10.3x ↓ 60: 9.9 ↓</p> <p>Series 92.5 556.3</p>
---	---	---	--

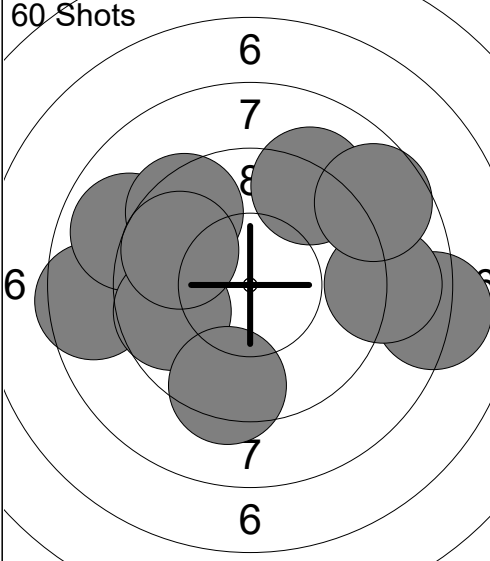
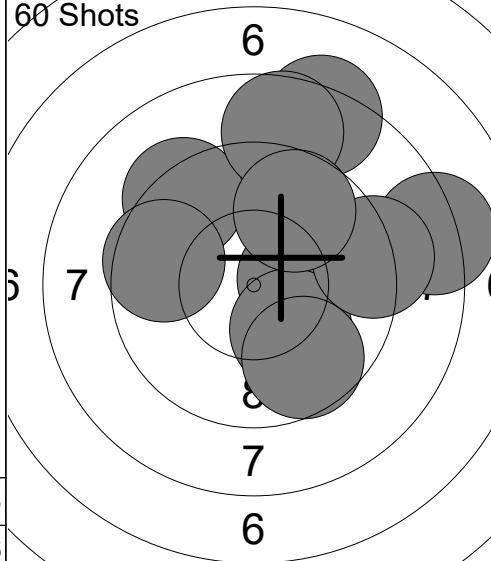
60 Shots 	1: 8.5 ← 2: 8.1 → 3: 8.9 ↖ 4: 9.2 ↗ 5: 9.7 ← 6: 9.4 ↓ 7: 8.9 → 8: 9.4 ↗ 9: 9.8 ↖ 10: 8.7 ↗ <hr/> Series 90.6 90.6	60 Shots 	11: 10.3x → 12: 10.1 ↘ 13: 8.2 → 14: 9.3 ↖ 15: 8.3 ↑ 16: 8.7 ↑ 17: 9.7 ↘ 18: 9.1 → 19: 9.7 ↑ 20: 9.6 ← <hr/> Series 93.0 183.6
--	--	--	---

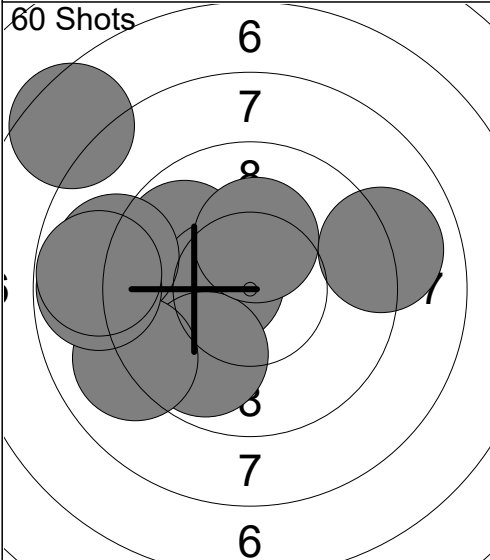
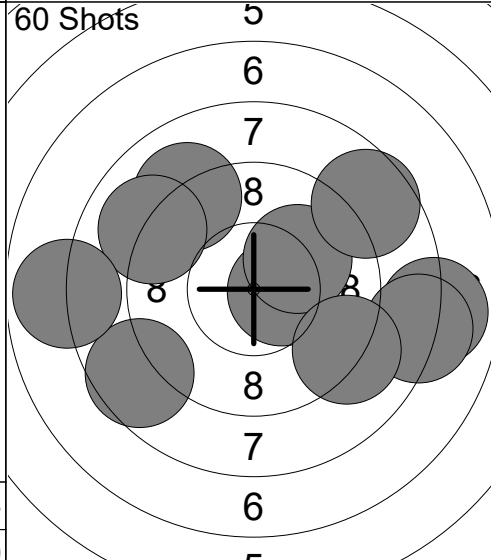
60 Shots 	21: 9.8 ↖ 22: 10.5x ← 23: 9.8 ↘ 24: 10.2x ↑ 25: 9.0 ← 26: 7.5 ↗ 27: 9.0 → 28: 9.0 ← 29: 8.8 ← 30: 8.8 ← <hr/> Series 92.4 276.0	60 Shots 	31: 9.1 ↖ 32: 10.5x → 33: 10.1 ↗ 34: 9.0 ↖ 35: 8.6 ← 36: 7.9 ← 37: 7.9 → 38: 8.2 → 39: 8.6 ↗ 40: 9.1 ↘ <hr/> Series 89.0 365.0
---	--	---	---

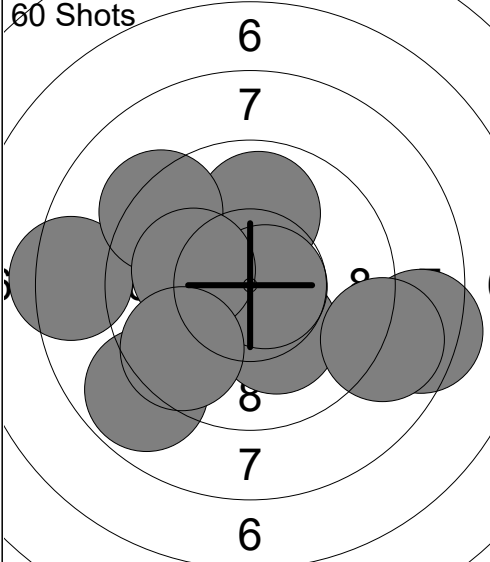
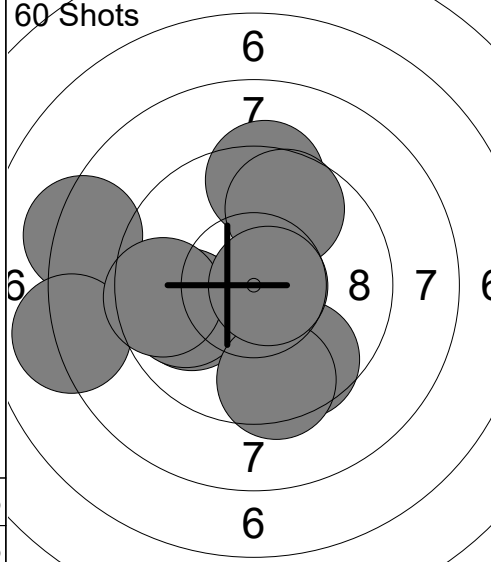
60 Shots 	41: 8.4 ← 42: 9.9 ↑ 43: 10.2x ↘ 44: 8.4 → 45: 9.3 ↗ 46: 8.9 → 47: 10.7x → 48: 8.8 ↘ 49: 10.1 ← 50: 9.6 ↘ <hr/> Series 94.3 459.3	60 Shots 	51: 9.6 ↘ 52: 9.9 ← 53: 9.9 ← 54: 9.4 ↑ 55: 8.3 ← 56: 9.7 ↑ 57: 9.5 ↘ 58: 8.1 ← 59: 9.6 ← 60: 10.7x → <hr/> Series 94.7 554.0
--	---	--	--

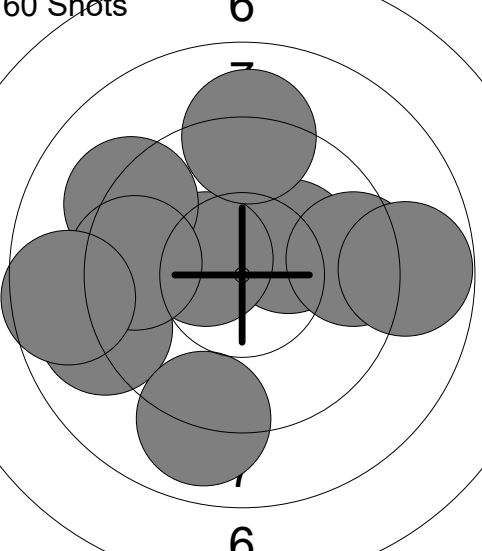
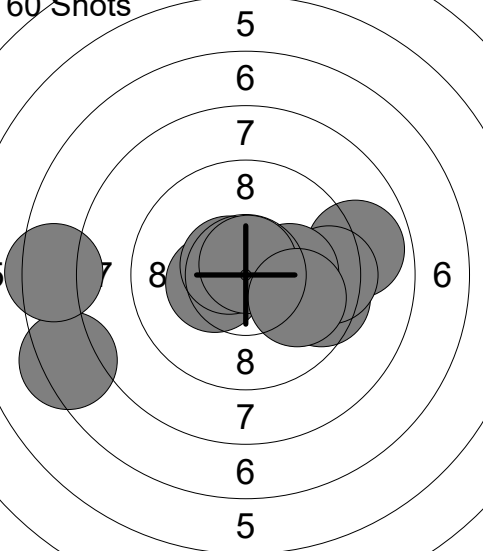
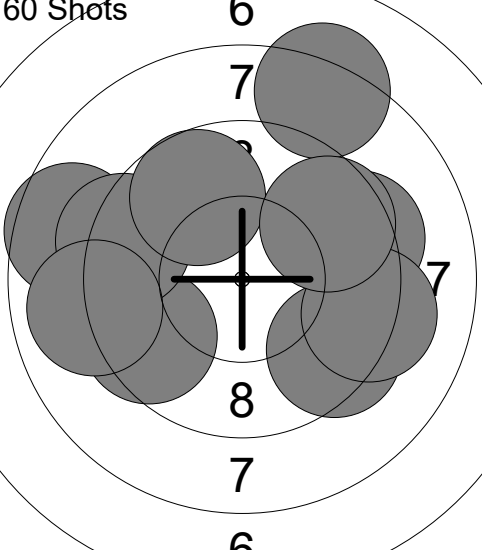
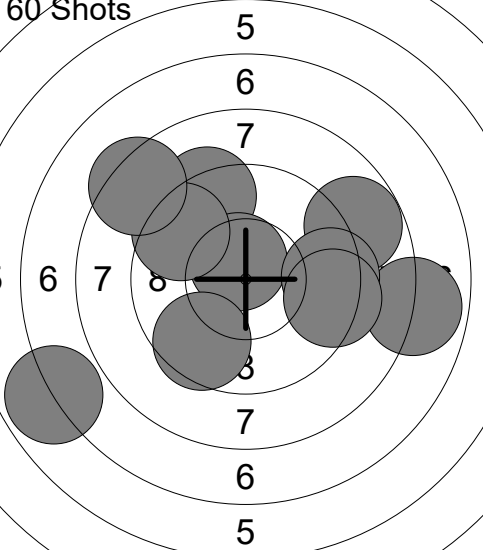
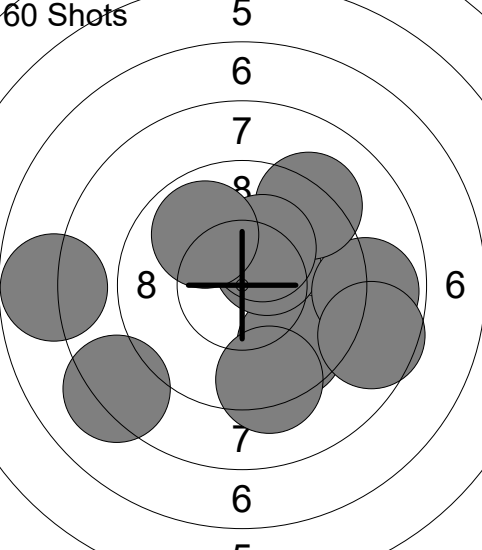
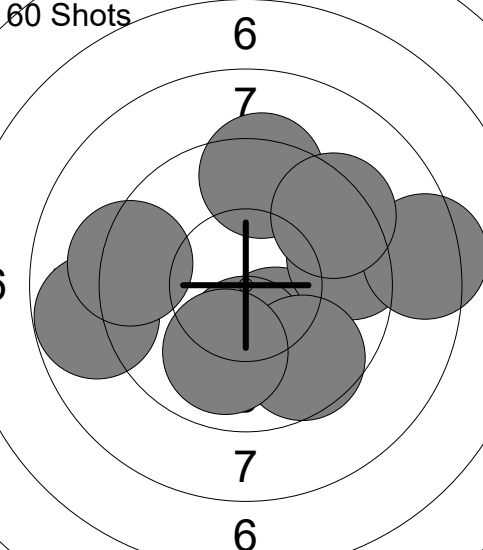
<p>60 Shots 6</p> 	<p>1: 10.2x ↗ 2: 10.4x ↖ 3: 9.2 ↖ 4: 9.1 ↑ 5: 9.0 ← 6: 9.5 ← 7: 9.0 ↓ 8: 9.5 → 9: 8.6 ← 10: 8.8 →</p> <p>Series 93.3 93.3</p>	<p>60 Shots 5</p> 	<p>11: 8.9 → 12: 9.5 → 13: 9.4 → 14: 10.4x ← 15: 7.3 ← 16: 10.1 → 17: 10.6x ↖ 18: 7.4 ← 19: 10.7x ↑ 20: 9.9 →</p> <p>Series 94.2 187.5</p>
<p>60 Shots 6</p> 	<p>21: 9.3 → 22: 8.6 ← 23: 9.5 ← 24: 9.3 ← 25: 9.4 ↘ 26: 8.2 ↑ 27: 9.0 ← 28: 9.7 ↑ 29: 9.2 → 30: 9.6 ↗</p> <p>Series 91.8 279.3</p>	<p>60 Shots 5</p> 	<p>31: 9.3 ↑ 32: 7.9 → 33: 10.6x ↑ 34: 8.8 → 35: 6.9 ← 36: 9.4 → 37: 9.6 ↓ 38: 9.3 → 39: 9.5 ↖ 40: 8.4 ↖</p> <p>Series 89.7 369.0</p>
<p>60 Shots 5</p> 	<p>41: 7.8 ← 42: 9.7 ↘ 43: 10.4x ↗ 44: 8.9 → 45: 8.6 → 46: 8.2 ↖ 47: 9.3 ↓ 48: 9.2 ↗ 49: 10.2x ↗ 50: 9.9 ↖</p> <p>Series 92.2 461.2</p>	<p>60 Shots 6</p> 	<p>51: 10.2x ↘ 52: 9.4 → 53: 8.4 → 54: 10.2x ↓ 55: 9.4 ↑ 56: 9.6 ↘ 57: 8.8 ← 58: 10.0 ↓ 59: 9.3 ← 60: 9.3 ↗</p> <p>Series 94.6 555.8</p>

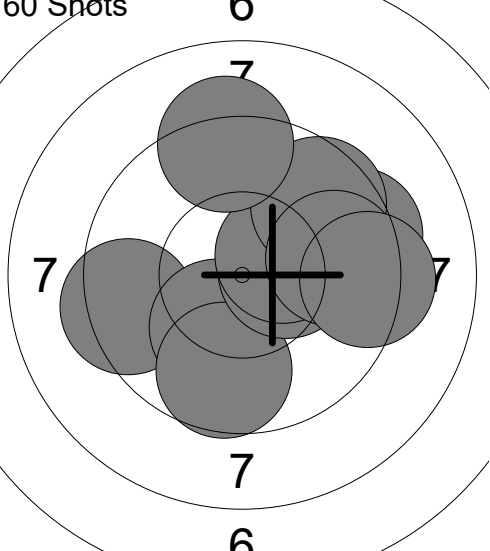
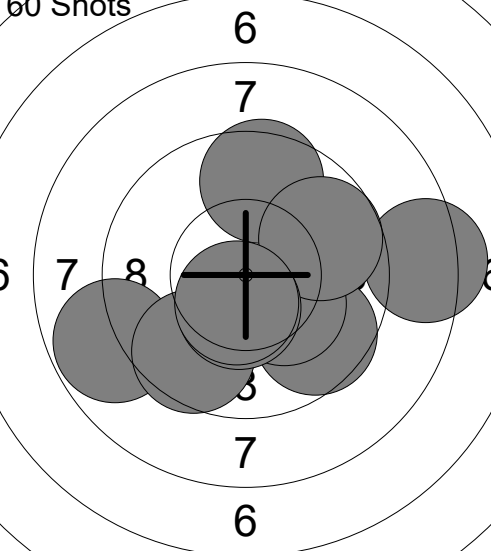
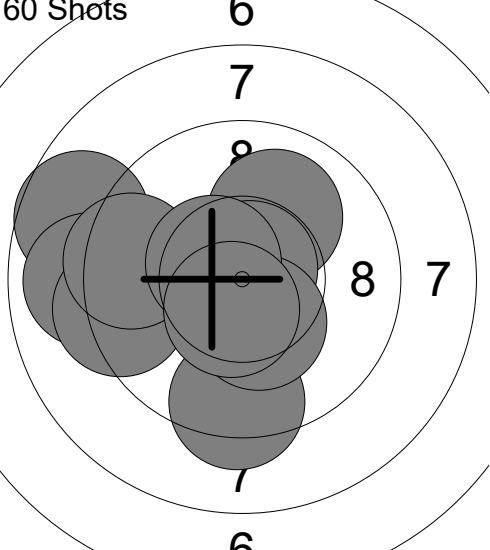
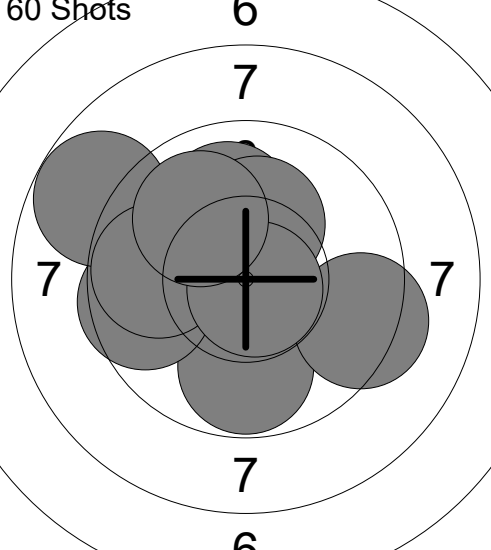
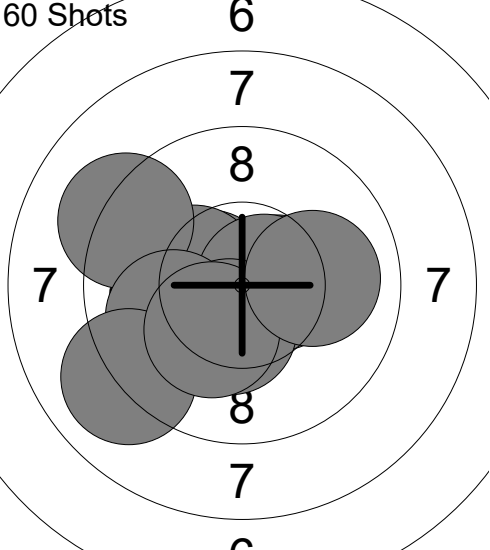
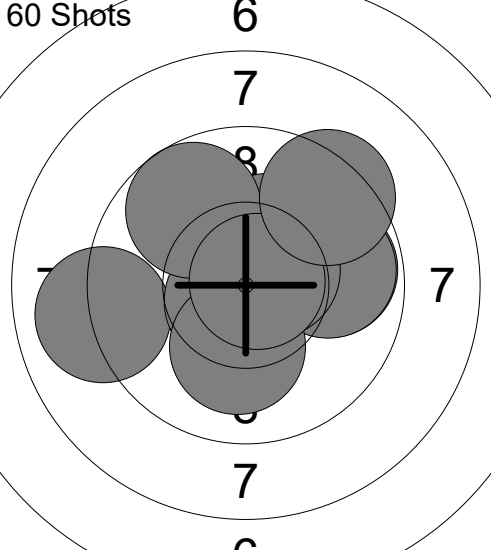
<p>60 Shots</p> 	<p>1: 9.4 ←</p> <p>2: 10.2x ↓</p> <p>3: 9.7 ↓</p> <p>4: 9.4 →</p> <p>5: 10.4x →</p> <p>6: 10.3x →</p> <p>7: 9.6 ↗</p> <p>8: 9.7 →</p> <p>9: 9.2 ↑</p> <p>10: 9.3 →</p> <hr/> <p>Series 97.2</p> <p style="text-align: center;">97.2</p>	<p>60 Shots</p> 	<p>11: 10.1 ⇒</p> <p>12: 8.3 →</p> <p>13: 9.6 ↓</p> <p>14: 9.6 ↑</p> <p>15: 10.2x ↓</p> <p>16: 9.7 ↗</p> <p>17: 8.8 ←</p> <p>18: 9.6 ↓</p> <p>19: 10.5x ↓</p> <p>20: 10.5x ↓</p> <hr/> <p>Series 96.9</p> <p style="text-align: center;">194.1</p>
<p>60 Shots</p> 	<p>21: 10.0 ↑</p> <p>22: 8.7 ←</p> <p>23: 9.3 ↓</p> <p>24: 8.9 ←</p> <p>25: 10.8x ↑</p> <p>26: 9.3 ←</p> <p>27: 9.5 ←</p> <p>28: 10.3x ↓</p> <p>29: 10.5x ←</p> <p>30: 10.5x ↓</p> <hr/> <p>Series 97.8</p> <p style="text-align: center;">291.9</p>	<p>60 Shots</p> 	<p>31: 10.5x ←</p> <p>32: 9.8 ↓</p> <p>33: 9.6 ←</p> <p>34: 9.3 ⇒</p> <p>35: 10.0 ↑</p> <p>36: 8.8 ←</p> <p>37: 10.2x ↑</p> <p>38: 9.8 ←</p> <p>39: 10.8x ↓</p> <p>40: 9.9 ↗</p> <hr/> <p>Series 98.7</p> <p style="text-align: center;">390.6</p>
<p>60 Shots</p> 	<p>41: 10.5x ←</p> <p>42: 10.5x →</p> <p>43: 10.3x ←</p> <p>44: 9.2 ←</p> <p>45: 10.7x →</p> <p>46: 10.4x ↓</p> <p>47: 9.9 ←</p> <p>48: 9.0 ←</p> <p>49: 10.2x ↓</p> <p>50: 10.0 →</p> <hr/> <p>Series 100.7</p> <p style="text-align: center;">491.3</p>	<p>60 Shots</p> 	<p>51: 9.0 ←</p> <p>52: 10.7x ↓</p> <p>53: 9.8 →</p> <p>54: 9.8 →</p> <p>55: 10.1 ↓</p> <p>56: 10.3x ↑</p> <p>57: 10.5x ↗</p> <p>58: 9.7 ↗</p> <p>59: 10.8x →</p> <p>60: 9.4 ↗</p> <hr/> <p>Series 100.1</p> <p style="text-align: center;">591.4</p>

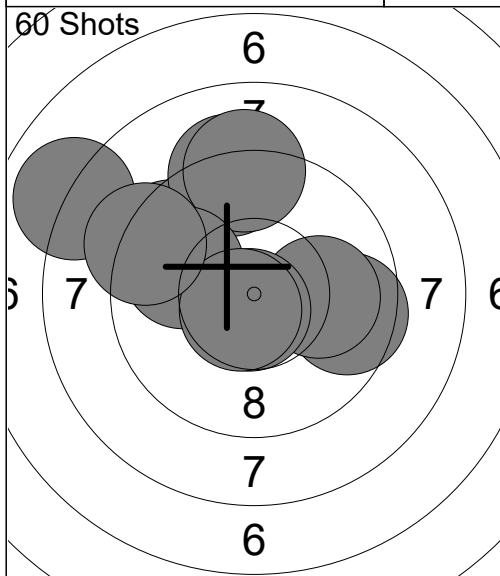

1:	9.5	↖
2:	9.2	↑
3:	9.1	↑
4:	8.0	↖
5:	9.8	↖
6:	9.6	→
7:	10.0	→
8:	10.7x	↓
9:	10.6x	↙
10:	9.2	↖
Series	95.7	
	95.7	

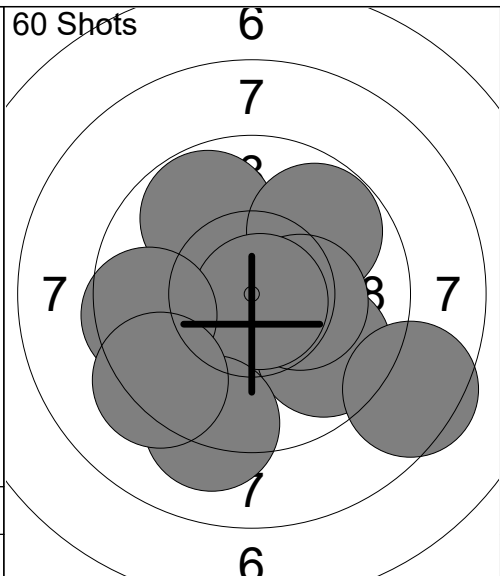

11:	9.8	↖
12:	10.4x	↙
13:	9.7	↘
14:	9.8	↗
15:	10.3x	→
16:	10.8x	↘
17:	9.6	←
18:	8.5	↘
19:	9.2	↓
20:	9.3	↙
Series	97.4	
	193.1	

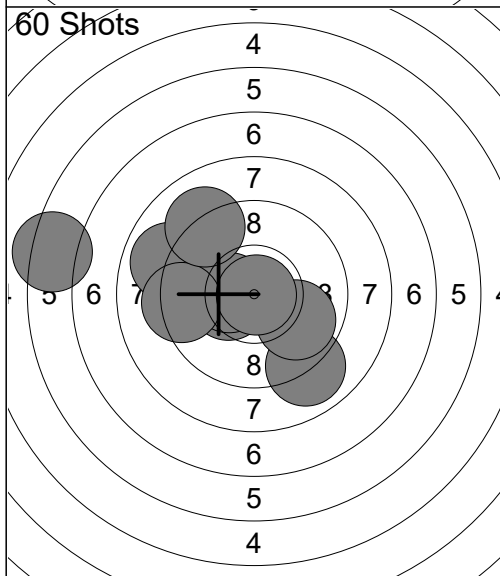

21:	9.0	↘
22:	9.9	↘
23:	9.4	↖
24:	8.9	↖
25:	10.4x	←
26:	10.4x	←
27:	6.3	←
28:	9.3	←
29:	10.9x	→
30:	9.1	↗
Series	93.6	
	286.7	

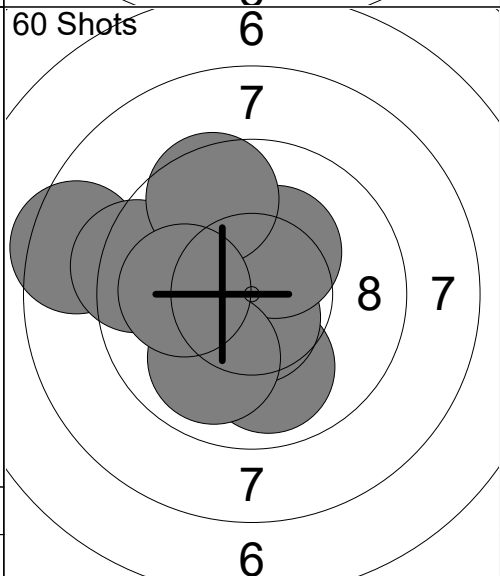

31:	10.4x	↑
32:	10.1	↙
33:	9.9	↓
34:	8.5	←
35:	10.6x	↓
36:	10.3x	↗
37:	9.3	←
38:	9.9	↙
39:	9.5	↗
40:	10.0	←
Series	98.5	
	385.2	

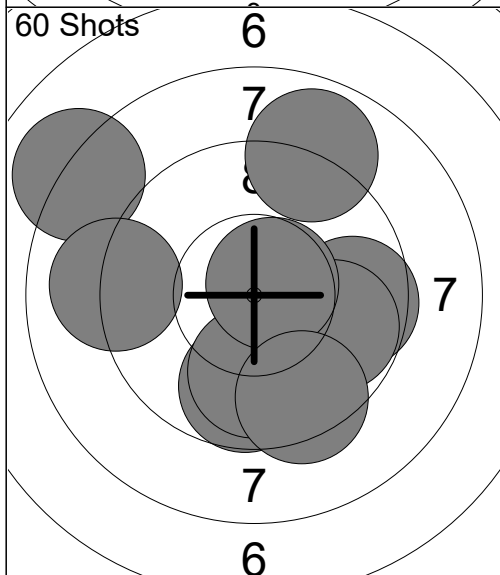

41:	9.6	→
42:	10.0	↓
43:	9.8	↘
44:	8.1	↗
45:	8.9	↑
46:	9.7	↓
47:	9.1	←
48:	9.9	↓
49:	10.7x	↗
50:	9.4	↓
Series	95.2	
	480.4	

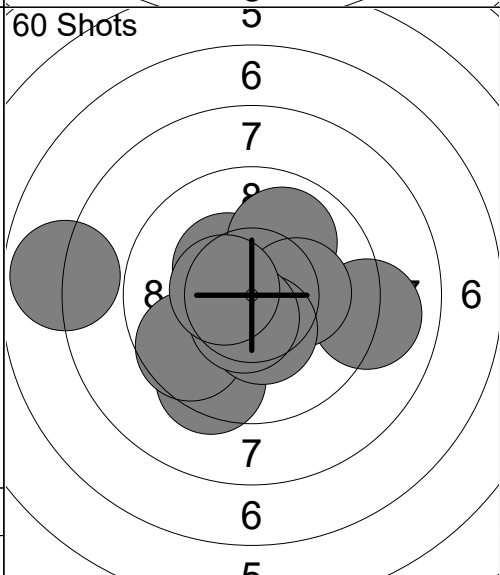

51:	10.4x	↖
52:	9.4	↙
53:	7.9	←
54:	10.0	↗
55:	9.0	→
56:	9.7	↙
57:	10.2x	→
58:	10.4x	↓
59:	10.6x	↓
60:	10.5x	←
Series	98.1	
	578.5	

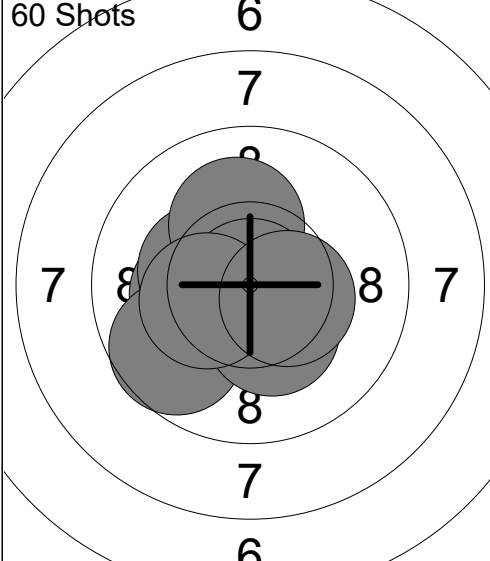
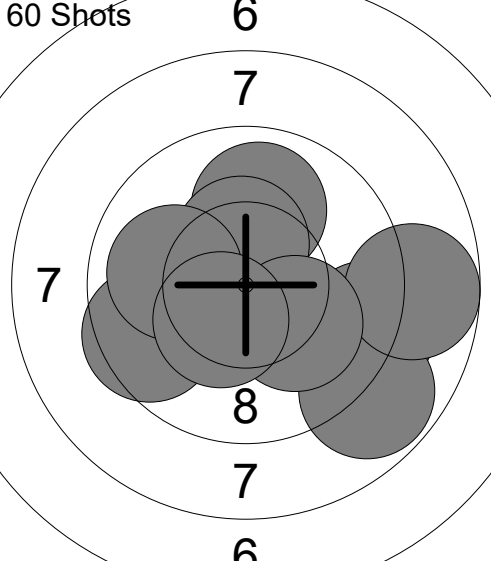
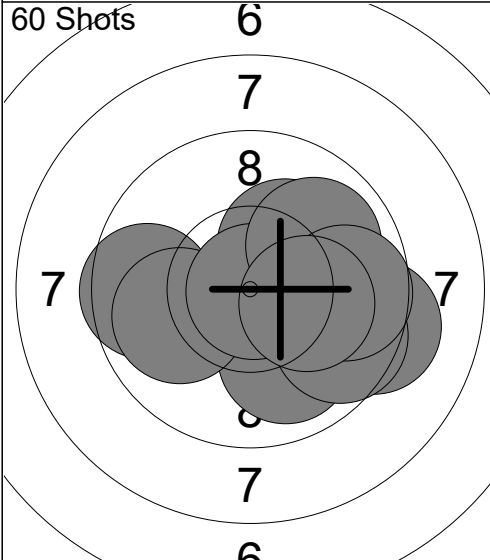
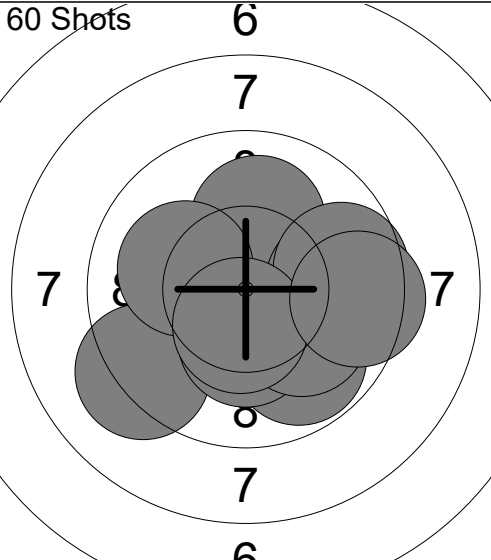
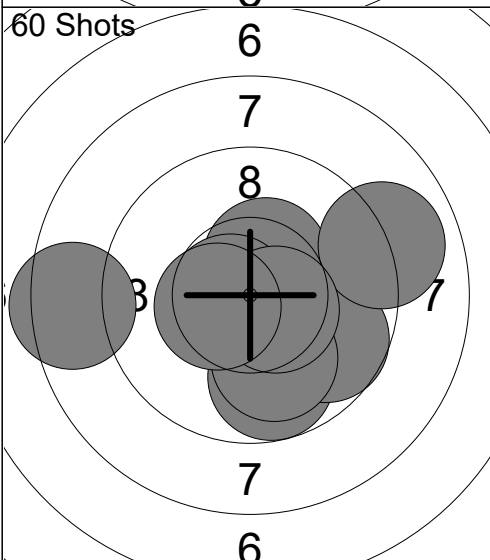
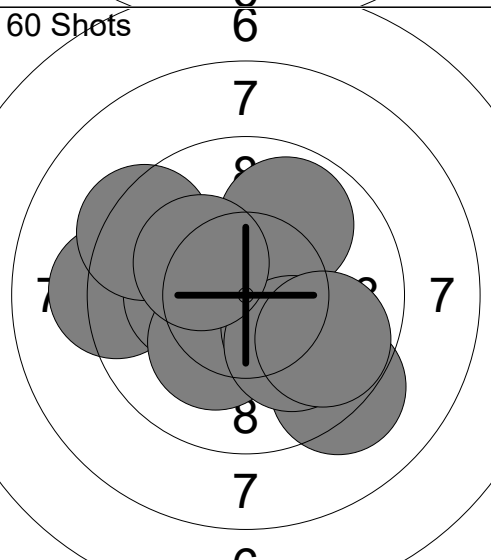
<p>60 Shots</p>  <p style="text-align: center;">6 7 8 7</p> <p style="text-align: center;">7 8 8 7</p> <p style="text-align: center;">7</p> <p style="text-align: center;">Series 103.8</p>	<p>60 Shots</p>  <p style="text-align: center;">6 7 8 7</p> <p style="text-align: center;">7 8 8 7</p> <p style="text-align: center;">7</p> <p style="text-align: center;">Series 97.2</p>	<p>11: 9.9 ↑</p> <p>12: 10.4x ↑</p> <p>13: 9.2 →</p> <p>14: 10.2x ↙</p> <p>15: 9.5 ↙</p> <p>16: 8.8 ↘</p> <p>17: 10.0 ←</p> <p>18: 8.7 →</p> <p>19: 10.1 ↘</p> <p>20: 10.4x ↙</p> <p style="text-align: center;">Series 201.0</p>
<p>60 Shots</p>  <p style="text-align: center;">6 7 8 7</p> <p style="text-align: center;">7 8 8 7</p> <p style="text-align: center;">7</p> <p style="text-align: center;">Series 99.2</p>	<p>60 Shots</p>  <p style="text-align: center;">6 7 8 7</p> <p style="text-align: center;">7 8 8 7</p> <p style="text-align: center;">7</p> <p style="text-align: center;">Series 99.0</p>	<p>21: 10.2x ↗</p> <p>22: 9.6 ←</p> <p>23: 9.9 ↘</p> <p>24: 10.0 ←</p> <p>25: 9.2 →</p> <p>26: 9.6 ↘</p> <p>27: 10.9x ↘</p> <p>28: 9.9 ↗</p> <p>29: 9.7 →</p> <p>30: 10.2x →</p> <p style="text-align: center;">Series 300.2</p>
<p>60 Shots</p>  <p style="text-align: center;">6 7 8 7</p> <p style="text-align: center;">7 8 8 7</p> <p style="text-align: center;">7</p> <p style="text-align: center;">Series 99.5</p>	<p>60 Shots</p>  <p style="text-align: center;">6 7 8 7</p> <p style="text-align: center;">7 8 8 7</p> <p style="text-align: center;">7</p> <p style="text-align: center;">Series 98.4</p>	<p>31: 9.2 ↙</p> <p>32: 9.8 ↘</p> <p>33: 10.1 ↑</p> <p>34: 10.3x ↓</p> <p>35: 10.1 ←</p> <p>36: 9.8 →</p> <p>37: 10.0 ↘</p> <p>38: 9.7 →</p> <p>39: 10.5x ↓</p> <p>40: 9.5 →</p> <p style="text-align: center;">Series 399.2</p>
<p>41: 9.8 ↘</p> <p>42: 9.7 →</p> <p>43: 10.4x ↑</p> <p>44: 9.0 →</p> <p>45: 10.5x ↘</p> <p>46: 10.0 ↘</p> <p>47: 10.7x ←</p> <p>48: 8.4 ←</p> <p>49: 10.5x →</p> <p>50: 10.5x ←</p> <p style="text-align: center;">Series 498.7</p>	<p>51: 9.2 ↘</p> <p>52: 9.2 ←</p> <p>53: 10.2x ←</p> <p>54: 10.2x ↙</p> <p>55: 10.2x ↘</p> <p>56: 9.9 ↑</p> <p>57: 10.1 ↘</p> <p>58: 9.4 ↙</p> <p>59: 10.2x ↙</p> <p>60: 9.8 ↘</p> <p style="text-align: center;">Series 597.1</p>	

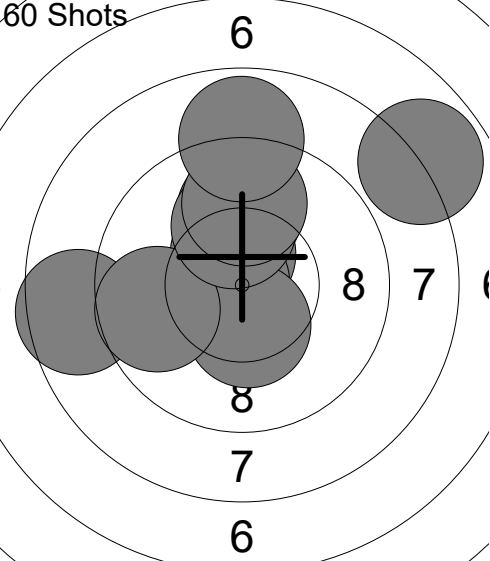
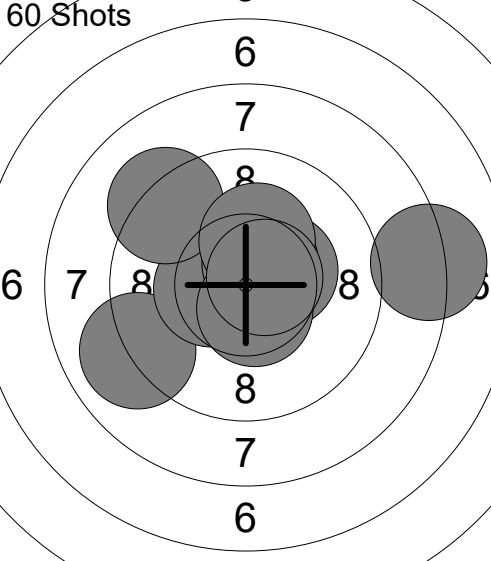
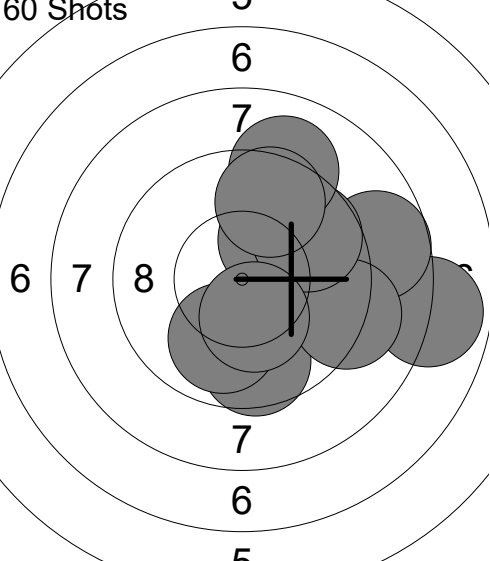
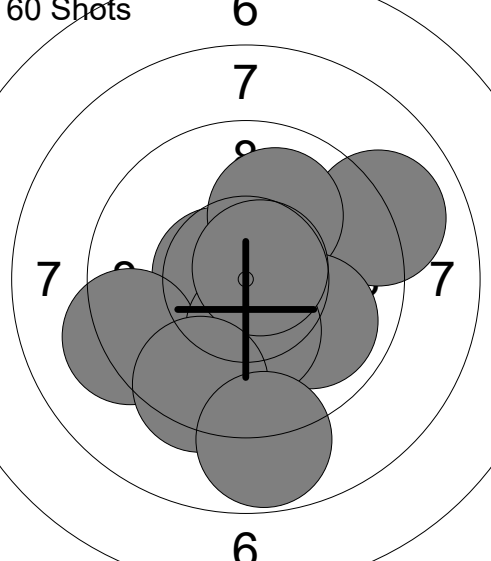
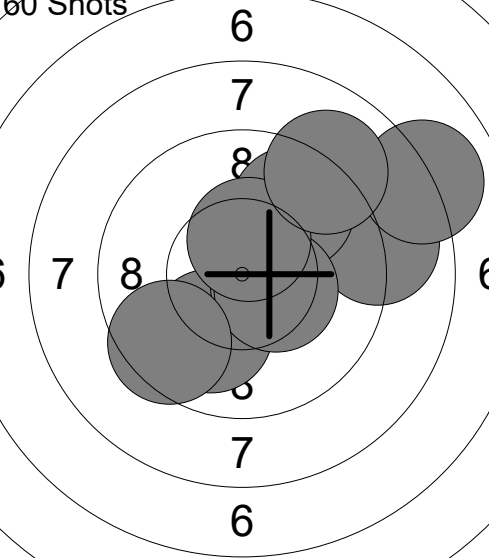
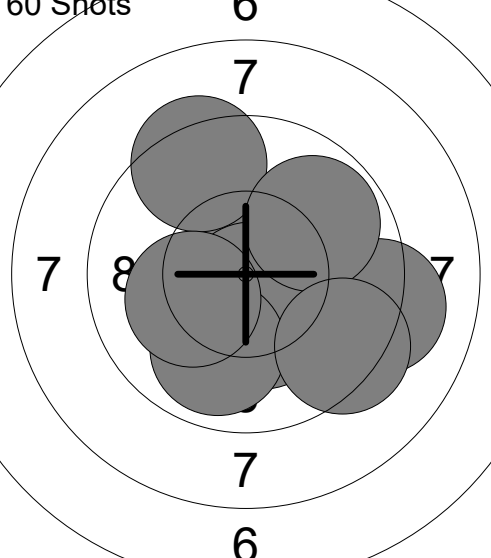
60 Shots 	1: 9.9 ↑ 2: 8.6 ← 3: 10.5x ↑ 4: 7.9 → 5: 10.7x ← 6: 10.4x ↓ 7: 9.7 ← 8: 10.1 ↑ 9: 9.8 ↑ 10: 8.9 ↑ <hr/> Series 96.5 96.5	60 Shots 	11: 10.4x → 12: 9.0 ← 13: 10.8x ↑ 14: 10.4x ← 15: 10.5x ↗ 16: 10.6x ↓ 17: 9.2 ↖ 18: 8.1 → 19: 10.2x ↑ 20: 10.6x → <hr/> Series 99.8 196.3
60 Shots 	21: 7.9 → 22: 10.1 ↗ 23: 8.7 → 24: 9.6 ↓ 25: 9.2 → 26: 9.7 → 27: 9.9 ↓ 28: 10.3x ↓ 29: 9.1 ↑ 30: 9.6 ↑ <hr/> Series 94.1 290.4	60 Shots 	31: 10.6x ← 32: 9.2 ← 33: 9.0 → 34: 10.3x ↓ 35: 10.0 ↑ 36: 9.9 → 37: 10.3x ↓ 38: 10.7x ↗ 39: 9.4 ↓ 40: 8.8 ↓ <hr/> Series 98.2 388.6
60 Shots 	41: 10.7x → 42: 10.0 ↓ 43: 10.5x → 44: 8.9 → 45: 9.7 ↗ 46: 8.0 → 47: 10.4x → 48: 10.4x ↑ 49: 9.0 ↗ 50: 9.5 ↙ <hr/> Series 97.1 485.7	60 Shots 	51: 10.4x ↗ 52: 10.3x ↓ 53: 10.8x → 54: 10.7x ↓ 55: 9.4 ↑ 56: 9.1 → 57: 9.9 ↓ 58: 9.8 ↗ 59: 9.4 → 60: 10.2x ← <hr/> Series 100.0 585.7

<p>60 Shots</p>	<p>60 Shots</p>
<p>60 Shots</p>	<p>60 Shots</p>
<p>60 Shots</p>	<p>60 Shots</p>

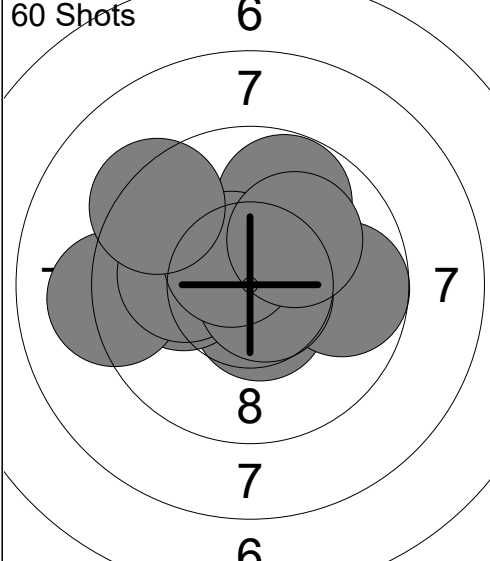
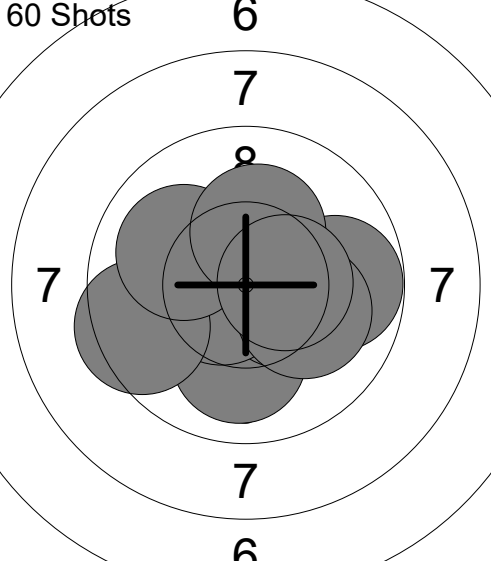
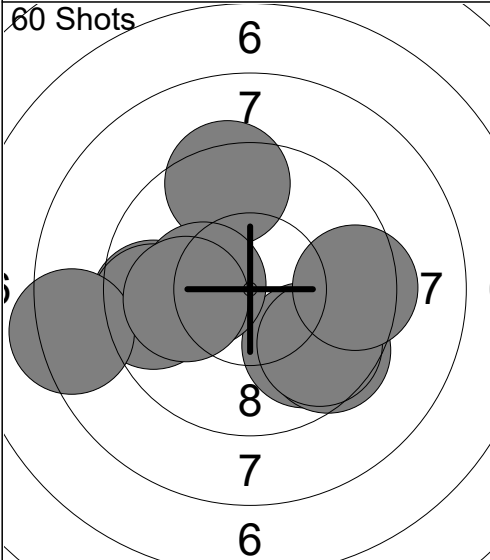
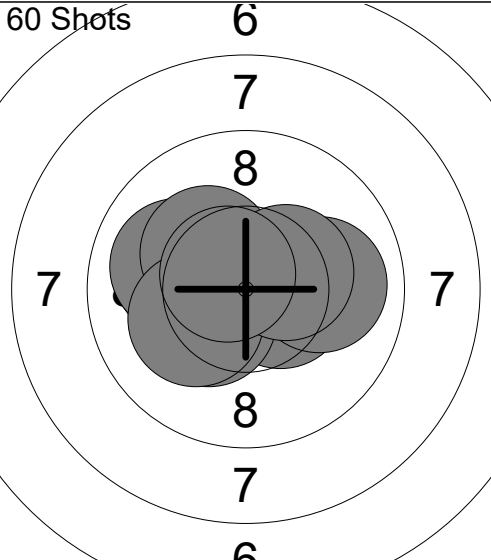
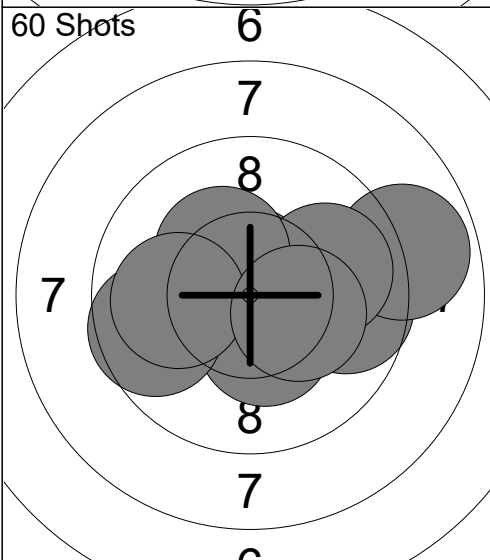
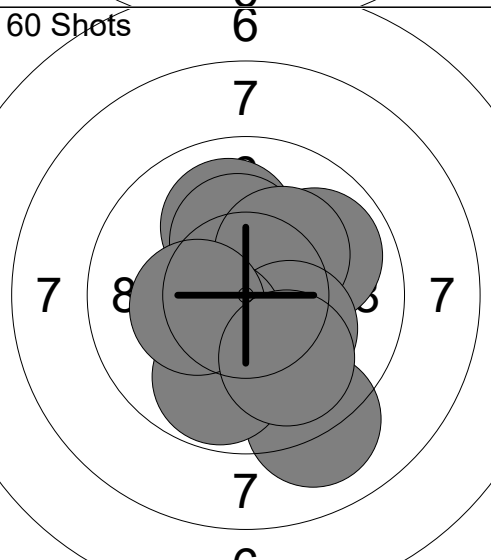
60 Shots  <p style="text-align: center;">6 7 7 8 7</p>	1: 10.6x ↓ 2: 9.8 ↑ 3: 10.1 ← 4: 9.1 ← 5: 10.1 ← 6: 9.7 → 7: 10.7x → 8: 10.5x ↗ 9: 10.1 ↗ 10: 9.3 ↖ Series 100.0 100.0	60 Shots  <p style="text-align: center;">6 7 8 7 7</p>	11: 10.0 ↓ 12: 10.4x → 13: 10.4x → 14: 10.6x ← 15: 9.8 → 16: 10.1 → 17: 9.5 ← 18: 10.0 ↖ 19: 10.2x ↑ 20: 10.4x → Series 101.4 201.4
60 Shots  <p style="text-align: center;">6 6 7 7 8 7 6</p>	21: 9.8 ↓ 22: 9.5 ↓ 23: 9.4 ↑ 24: 9.5 ← 25: 9.5 ← 26: 9.7 ↓ 27: 8.3 ← 28: 10.3x ← 29: 10.0 ← 30: 9.4 → Series 95.4 296.8	60 Shots  <p style="text-align: center;">6 7 8 7 8 7 6</p>	31: 10.0 ← 32: 10.1 ← 33: 10.5x → 34: 10.0 ← 35: 10.0 → 36: 10.3x ↖ 37: 10.3x ↖ 38: 10.2x ← 39: 10.4x → 40: 10.6x ↖ Series 102.4 399.2
60 Shots  <p style="text-align: center;">6 7 8 7 8 7 6</p>	41: 10.8x ↙ 42: 9.7 → 43: 10.7x ↑ 44: 8.9 → 45: 9.9 → 46: 10.3x ↓ 47: 9.6 ← 48: 10.3x ↗ 49: 10.0 ← 50: 10.3x → Series 100.5 499.7	60 Shots  <p style="text-align: center;">6 7 8 7 8 7 6</p>	51: 9.9 ↗ 52: 10.0 ↑ 53: 10.2x ↑ 54: 10.2x ↗ 55: 10.2x → 56: 9.1 ↓ 57: 10.4x ↖ 58: 9.8 ↓ 59: 10.3x ← 60: 10.0 ↓ Series 100.1 599.8

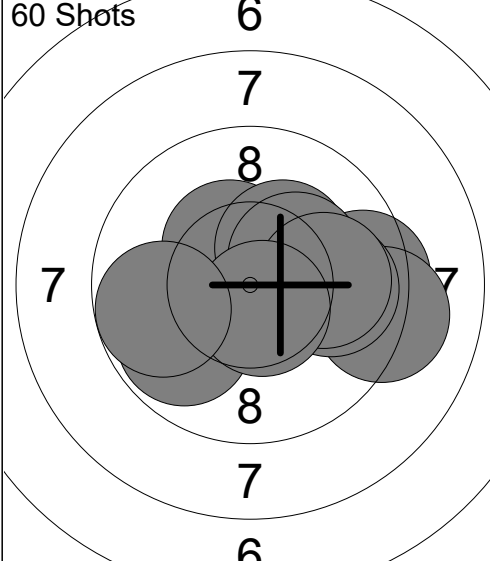
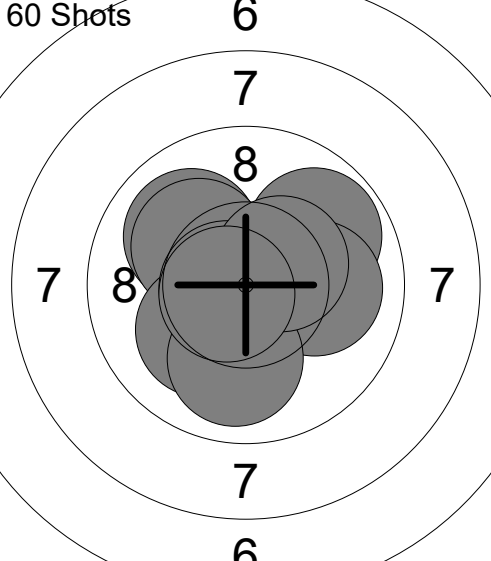
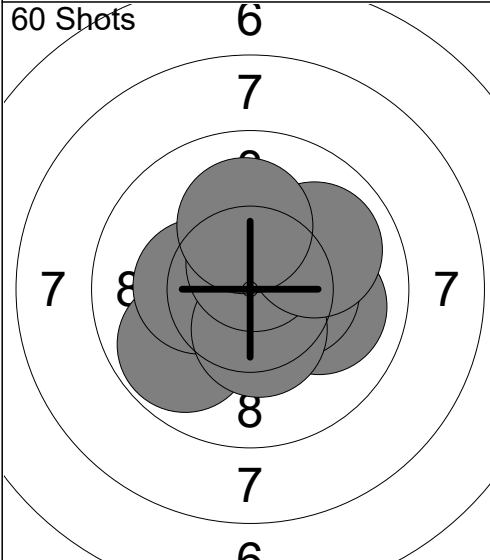
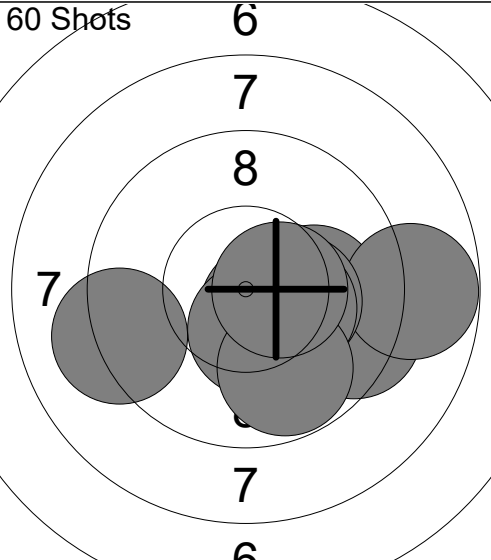
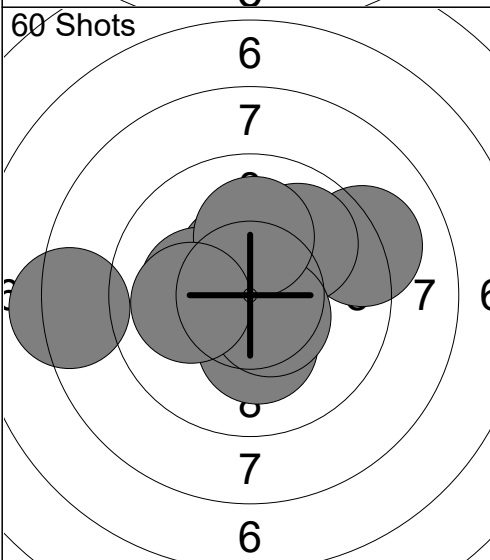
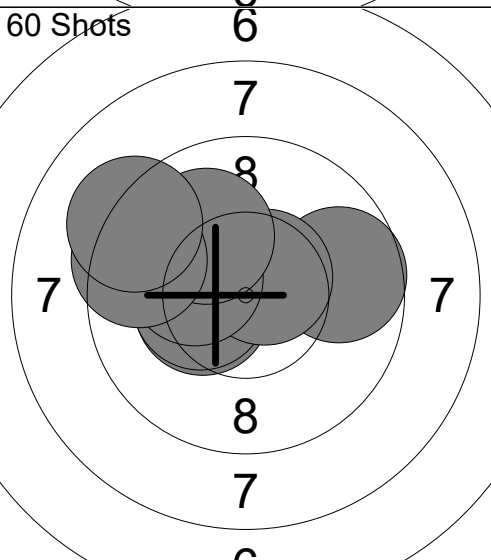
60 Shots 	1: 9.5 → 2: 10.4x ↖ 3: 10.3x ↗ 4: 10.3x ↗ 5: 9.2 → 6: 9.9 → 7: 9.8 ↙ 8: 10.0 → 9: 10.6x ↘ 10: 9.8 ← <hr/> Series 99.8 99.8	60 Shots 	11: 10.0 ↖ 12: 9.8 ↗ 13: 10.5x ↙ 14: 10.2x ↖ 15: 10.0 → 16: 10.1 ↙ 17: 10.7x ↙ 18: 10.0 ↓ 19: 10.4x ↗ 20: 10.7x ↙ <hr/> Series 102.4 202.2
60 Shots 	21: 10.9x ↘ 22: 9.8 ↙ 23: 10.0 → 24: 10.4x → 25: 10.7x ↙ 26: 10.3x ↙ 27: 10.4x ↘ 28: 10.6x ↗ 29: 10.0 ↗ 30: 10.1 ↗ <hr/> Series 103.2 305.4	60 Shots 	31: 10.1 → 32: 9.4 → 33: 8.8 → 34: 10.6x ↘ 35: 10.3x → 36: 10.3x → 37: 10.4x ↘ 38: 9.2 ← 39: 9.8 ↘ 40: 10.5x → <hr/> Series 99.4 404.8
60 Shots 	41: 10.2x ↘ 42: 9.1 ↗ 43: 8.3 ← 44: 10.4x ↗ 45: 9.9 ↗ 46: 10.6x ↗ 47: 10.2x ↙ 48: 10.5x ↘ 49: 10.1 ↗ 50: 10.1 ← <hr/> Series 99.4 504.2	60 Shots 	51: 9.7 → 52: 9.9 ↙ 53: 10.4x ↙ 54: 10.4x ↙ 55: 10.3x ↙ 56: 10.6x ↗ 57: 10.2x ↙ 58: 10.0 ↗ 59: 9.5 ↙ 60: 9.2 ↙ <hr/> Series 100.2 604.4

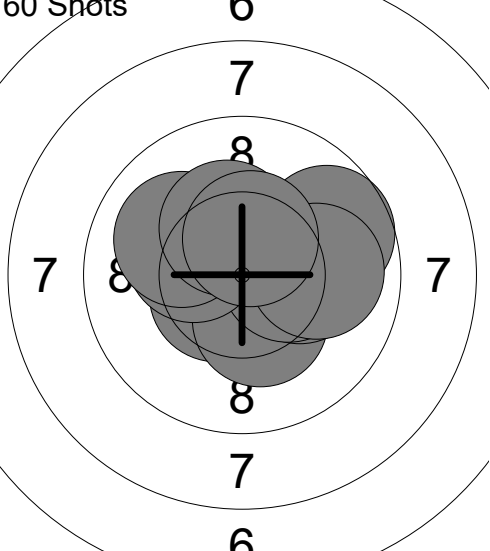
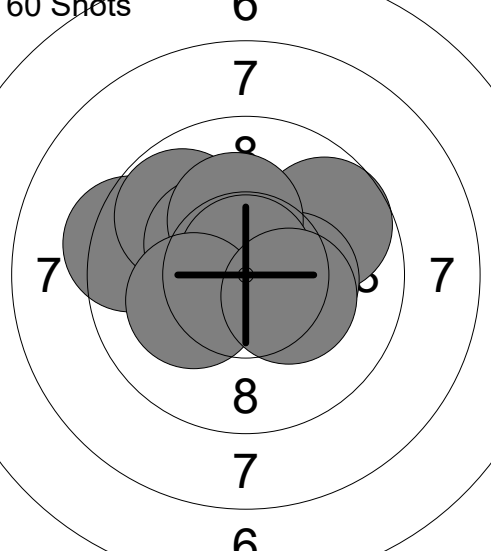
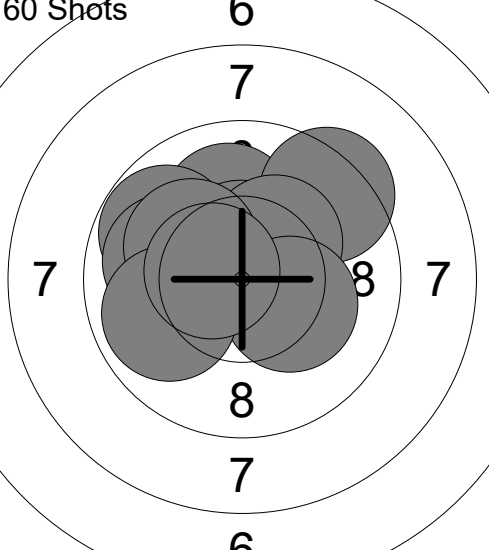
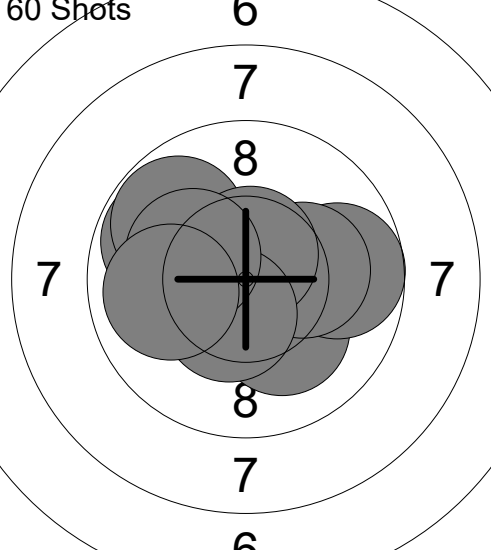
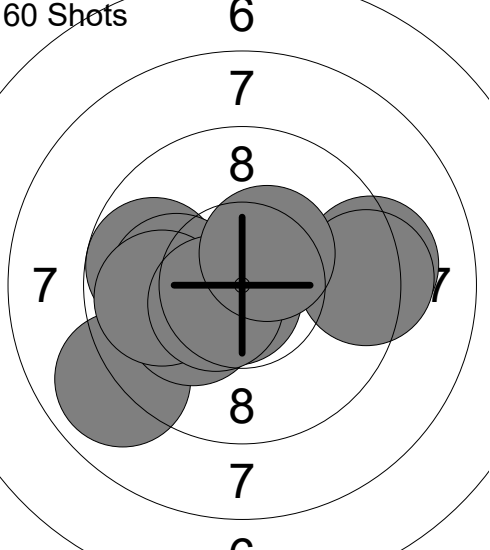
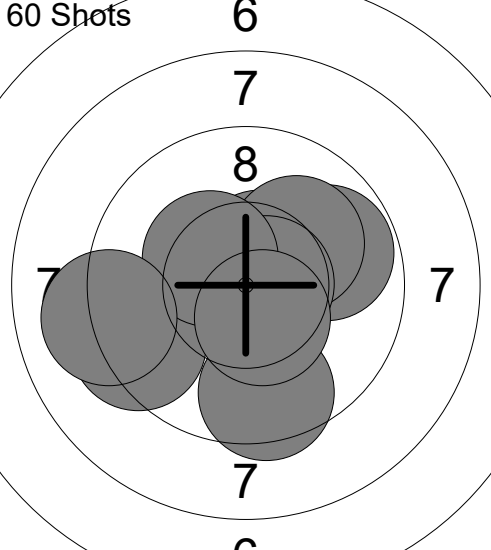
<p>60 Shots</p>  <p style="text-align: center;">6 7 8 7 8 7</p>	<p>1: 10.5x ↙ 2: 10.3x ↓ 3: 10.2x → 4: 10.3x → 5: 10.2x ↙ 6: 10.0 ↖ 7: 9.7 → 8: 10.3x ↑ 9: 10.0 → 10: 10.5x ↑</p> <p>Series 102.0 102.0</p>	<p>60 Shots</p>  <p style="text-align: center;">6 7 8 7 8 7</p>	<p>11: 9.7 → 12: 10.3x → 13: 10.3x ↗ 14: 9.4 ↖ 15: 9.8 ↗ 16: 10.3x ↖ 17: 10.2x ↑ 18: 10.8x ↑ 19: 10.2x ↖ 20: 10.3x →</p> <p>Series 101.3 203.3</p>
<p>60 Shots</p>  <p style="text-align: center;">6 7 8 7 8 7</p>	<p>21: 10.0 ↑ 22: 9.4 ↗ 23: 9.8 ↖ 24: 10.5x ↑ 25: 10.3x ↗ 26: 10.0 ↖ 27: 10.2x → 28: 10.2x ↖ 29: 9.9 ↖ 30: 10.5x ↖</p> <p>Series 100.8 304.1</p>	<p>60 Shots</p>  <p style="text-align: center;">6 7 8 7 8 7</p>	<p>31: 9.8 ↖ 32: 10.1 ↓ 33: 9.7 → 34: 10.1 ↖ 35: 10.2x → 36: 9.8 ↖ 37: 10.6x ↑ 38: 10.4x ↓ 39: 10.2x ↖ 40: 9.9 ↖</p> <p>Series 100.8 404.9</p>
<p>60 Shots</p>  <p style="text-align: center;">6 7 8 7 8 7 6</p>	<p>41: 9.7 ↖ 42: 8.9 ↖ 43: 10.2x ↖ 44: 10.8x ↖ 45: 10.1 ↖ 46: 9.2 → 47: 9.9 ↖ 48: 10.5x ↖ 49: 9.3 → 50: 10.4x ↗</p> <p>Series 99.0 503.9</p>	<p>60 Shots</p>  <p style="text-align: center;">6 7 8 7 8 7 6</p>	<p>51: 10.5x ↗ 52: 9.8 → 53: 10.1 ↗ 54: 9.5 ↓ 55: 10.8x ↓ 56: 9.3 ↖ 57: 10.7x → 58: 10.4x ↖ 59: 10.5x ↓ 60: 9.1 ↖</p> <p>Series 100.7 604.6</p>

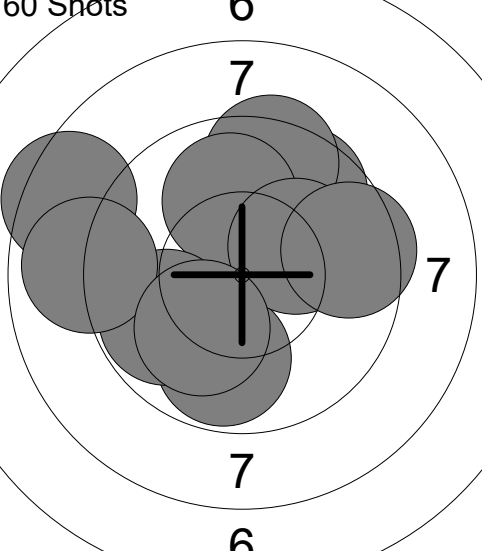
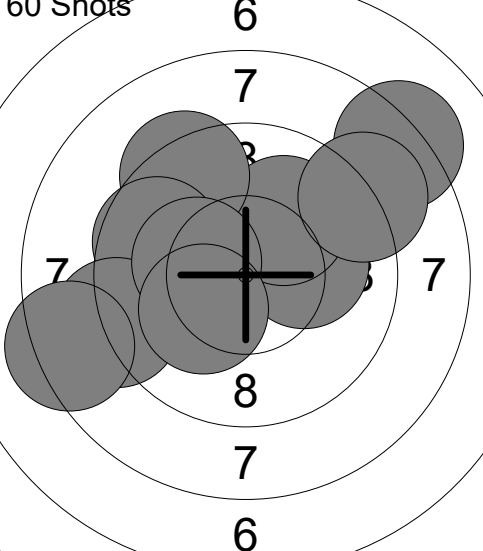
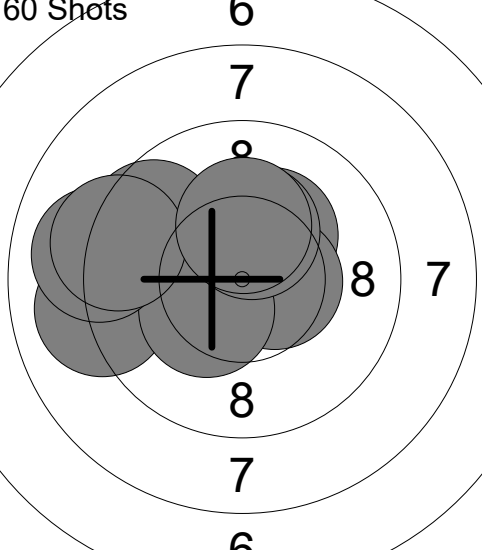
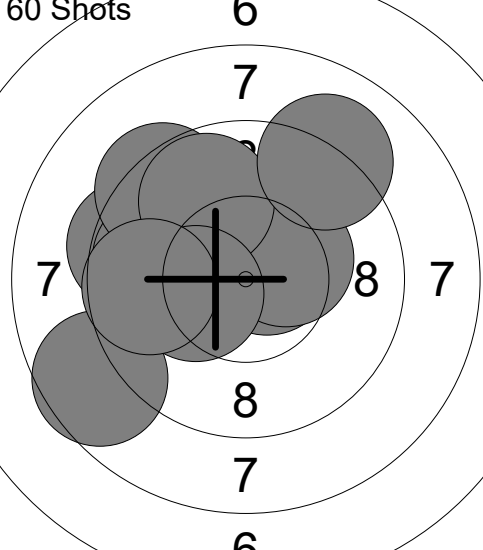
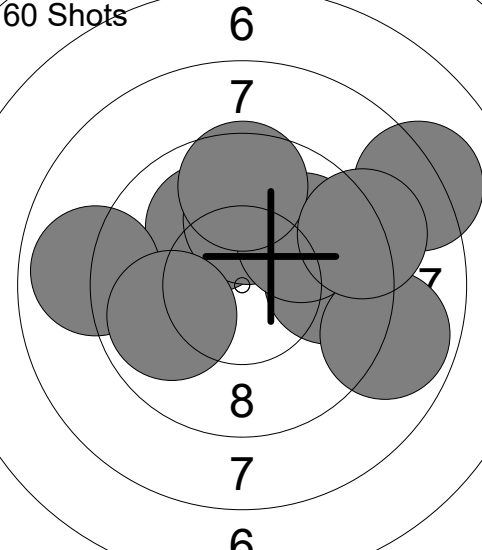
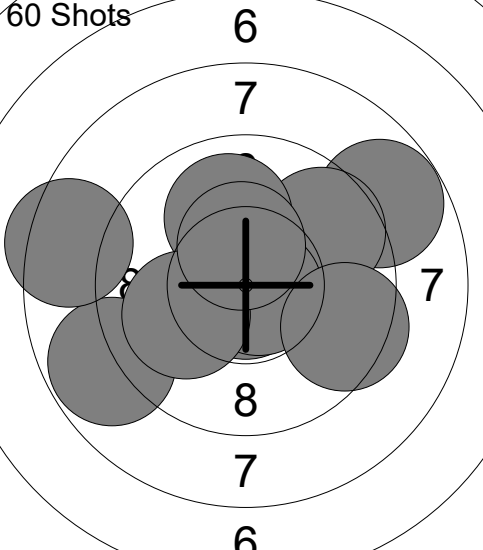
<p>60 Shots</p> 	<p>1: 9.6 ↗ 2: 9.4 ↑ 3: 9.8 ↓ 4: 10.0 ↑ 5: 10.1 → 6: 9.8 ← 7: 8.5 ← 8: 8.9 ← 9: 10.1 ↓ 10: 9.5 →</p> <p>Series 95.7</p> <p style="text-align: center;">95.7</p>	<p>60 Shots</p> 	<p>11: 10.1 → 12: 10.0 ↗ 13: 8.2 ↗ 14: 9.3 ↖ 15: 9.0 ↗ 16: 9.6 ← 17: 9.0 ← 18: 8.3 ← 19: 10.2x ← 20: 10.2x ↙</p> <p>Series 93.9</p> <p style="text-align: center;">189.6</p>
<p>60 Shots</p> 	<p>21: 10.3x ↗ 22: 10.2x ← 23: 10.5x → 24: 9.6 ↖ 25: 9.1 ← 26: 10.3x ↙ 27: 10.3x ↑ 28: 9.0 ← 29: 9.2 ← 30: 10.2x ↑</p> <p>Series 98.7</p> <p style="text-align: center;">288.3</p>	<p>60 Shots</p> 	<p>31: 9.4 ← 32: 10.6x ↗ 33: 9.8 ← 34: 10.4x ↗ 35: 9.3 ↖ 36: 9.8 ↑ 37: 10.3x ← 38: 9.1 ↗ 39: 8.6 ← 40: 9.7 ←</p> <p>Series 97.0</p> <p style="text-align: center;">385.3</p>
<p>60 Shots</p> 	<p>41: 8.2 ↗ 42: 10.0 ↖ 43: 10.0 ↑ 44: 8.9 ← 45: 9.9 ← 46: 9.7 → 47: 9.9 ↗ 48: 8.9 → 49: 9.6 ↑ 50: 9.1 →</p> <p>Series 94.2</p> <p style="text-align: center;">479.5</p>	<p>60 Shots</p> 	<p>51: 8.8 ↗ 52: 8.8 ← 53: 10.8x ↓ 54: 9.7 ↗ 55: 8.4 ← 56: 10.8x → 57: 10.0 ↑ 58: 10.0 ← 59: 10.4x ↑ 60: 9.4 →</p> <p>Series 97.1</p> <p style="text-align: center;">576.6</p>

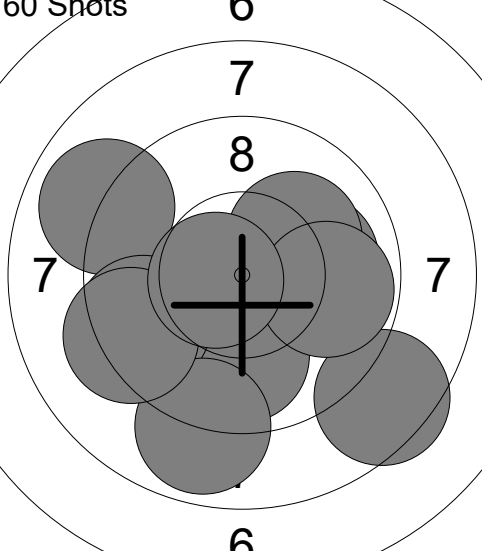
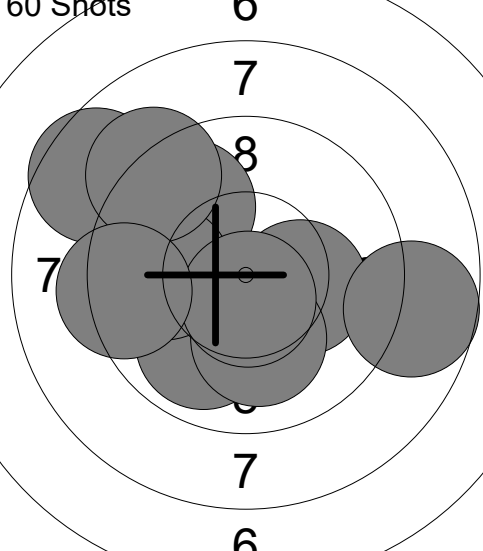
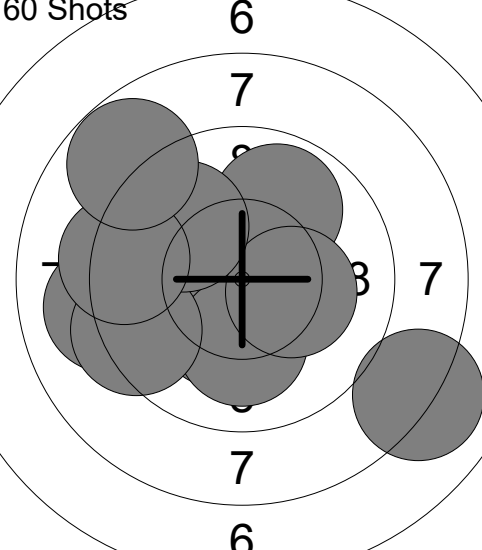
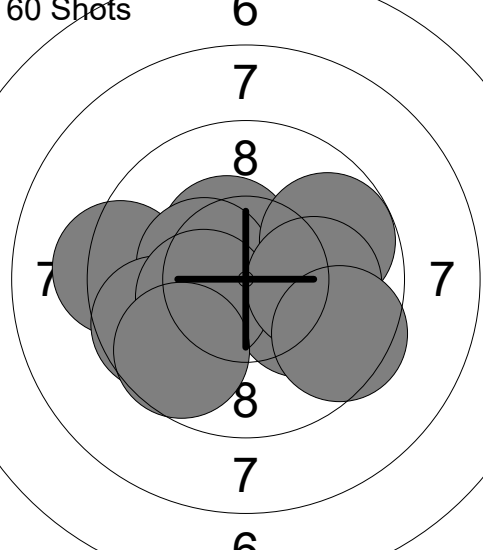
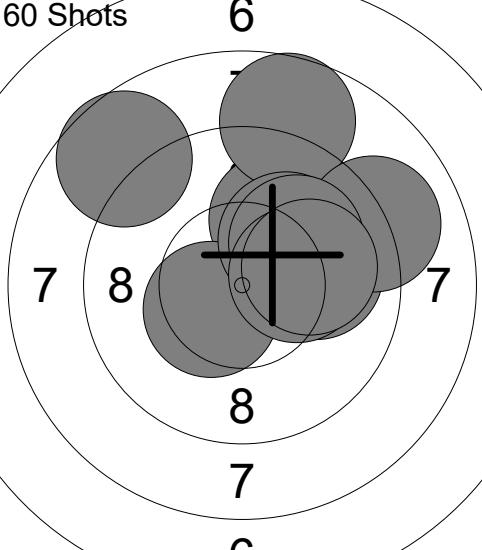
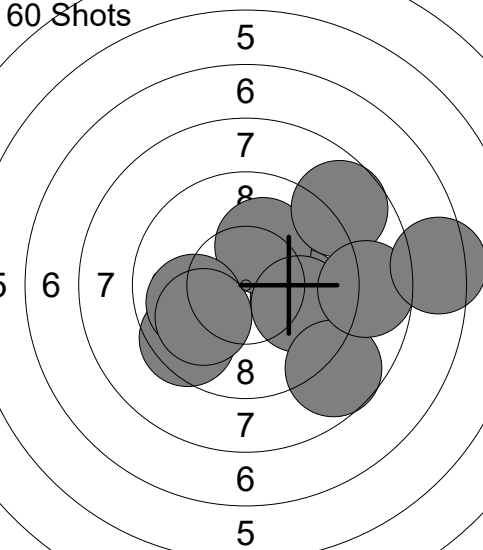
<p>60 Shots</p> 	<p>1: 9.9 ↓</p> <p>2: 8.9 ↖</p> <p>3: 8.5 ↘</p> <p>4: 9.5 ←</p> <p>5: 8.9 ↓</p> <p>6: 9.3 ←</p> <p>7: 10.0 →</p> <p>8: 10.1 ↗</p> <p>9: 9.8 →</p> <p>10: 10.6x ←</p> <hr/> <p>Series 95.5</p> <hr/> <p>95.5</p>	<p>60 Shots</p> 	<p>11: 8.6 ↗</p> <p>12: 9.8 ↗</p> <p>13: 10.2x →</p> <p>14: 9.9 ↓</p> <p>15: 9.9 ←</p> <p>16: 10.1 ↓</p> <p>17: 9.1 ↗</p> <p>18: 10.6x ↓</p> <p>19: 9.3 ←</p> <p>20: 8.7 →</p> <hr/> <p>Series 96.2</p> <hr/> <p>191.7</p>
<p>60 Shots</p> 	<p>21: 10.3x ↓</p> <p>22: 10.1 ↓</p> <p>23: 9.9 ↗</p> <p>24: 8.1 ↘</p> <p>25: 9.1 ←</p> <p>26: 10.3x →</p> <p>27: 9.3 ←</p> <p>28: 9.9 ↗</p> <p>29: 9.3 ←</p> <p>30: 8.8 ↗</p> <hr/> <p>Series 95.1</p> <hr/> <p>286.8</p>	<p>60 Shots</p> 	<p>31: 10.4x ↗</p> <p>32: 9.3 ←</p> <p>33: 10.1 ↘</p> <p>34: 10.4x ←</p> <p>35: 9.7 ←</p> <p>36: 9.7 ↗</p> <p>37: 10.3x ←</p> <p>38: 9.7 ↓</p> <p>39: 10.0 →</p> <p>40: 9.5 ↘</p> <hr/> <p>Series 99.1</p> <hr/> <p>385.9</p>
<p>60 Shots</p> 	<p>41: 10.0 ↗</p> <p>42: 8.7 ↗</p> <p>43: 10.0 →</p> <p>44: 8.7 ↖</p> <p>45: 10.4x ↘</p> <p>46: 9.0 ↗</p> <p>47: 10.1 ↗</p> <p>48: 10.0 ↗</p> <p>49: 10.2x →</p> <p>50: 10.0 →</p> <hr/> <p>Series 97.1</p> <hr/> <p>483.0</p>	<p>60 Shots</p> 	<p>51: 9.9 →</p> <p>52: 10.2x ↗</p> <p>53: 9.5 ↓</p> <p>54: 9.9 ←</p> <p>55: 9.9 →</p> <p>56: 10.0 ←</p> <p>57: 8.7 ↘</p> <p>58: 8.7 ↗</p> <p>59: 8.7 →</p> <p>60: 7.4 →</p> <hr/> <p>Series 92.9</p> <hr/> <p>575.9</p>

<p>60 Shots</p>	<p>1: 8.5 ↑</p> <p>2: 8.8 ↖</p> <p>3: 10.0 ↓</p> <p>4: 9.1 →</p> <p>5: 9.4 ↗</p> <p>6: 10.1 ↗</p> <p>7: 9.1 ↗</p> <p>8: 9.7 →</p> <p>9: 8.8 ↑</p> <p>10: 10.4x ↓</p> <p>Series 93.9</p>	<p>60 Shots</p>	<p>11: 9.6 ↙</p> <p>12: 9.4 ↗</p> <p>13: 8.0 →</p> <p>14: 10.1 ↗</p> <p>15: 10.4x ↙</p> <p>16: 9.5 →</p> <p>17: 8.9 ↓</p> <p>18: 10.0 ↖</p> <p>19: 10.7x →</p> <p>20: 9.9 ↖</p> <p>Series 96.5</p>
93.9		190.4	
<p>60 Shots</p>	<p>21: 9.8 ↓</p> <p>22: 10.5x ↗</p> <p>23: 10.4x ↓</p> <p>24: 10.0 ↓</p> <p>25: 10.5x ↖</p> <p>26: 9.7 →</p> <p>27: 9.9 ↓</p> <p>28: 7.8 ↖</p> <p>29: 9.1 ↗</p> <p>30: 10.2x ↑</p> <p>Series 97.9</p>	<p>60 Shots</p>	<p>31: 9.3 ↑</p> <p>32: 10.5x ↖</p> <p>33: 10.5x ↖</p> <p>34: 8.1 →</p> <p>35: 9.4 ↑</p> <p>36: 10.6x ↗</p> <p>37: 10.4x ↓</p> <p>38: 9.9 ↗</p> <p>39: 9.5 ↓</p> <p>40: 10.9x ↗</p> <p>Series 99.1</p>
288.3		387.4	
<p>60 Shots</p>	<p>41: 9.2 ↑</p> <p>42: 10.4x ↖</p> <p>43: 8.1 ↗</p> <p>44: 9.8 →</p> <p>45: 10.4x ↖</p> <p>46: 7.3 →</p> <p>47: 9.7 ↗</p> <p>48: 10.2x ↗</p> <p>49: 9.2 ↓</p> <p>50: 9.6 ↑</p> <p>Series 93.9</p>	<p>60 Shots</p>	<p>51: 8.4 ↖</p> <p>52: 10.3x ↑</p> <p>53: 9.9 →</p> <p>54: 10.3x ↑</p> <p>55: 9.3 ↖</p> <p>56: 9.9 ↗</p> <p>57: 9.1 ↖</p> <p>58: 9.2 ↖</p> <p>59: 10.1 ↑</p> <p>60: 10.6x ↗</p> <p>Series 97.1</p>
481.3		578.4	

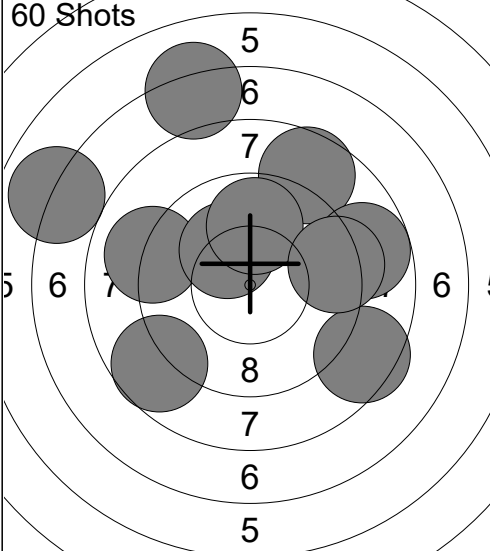
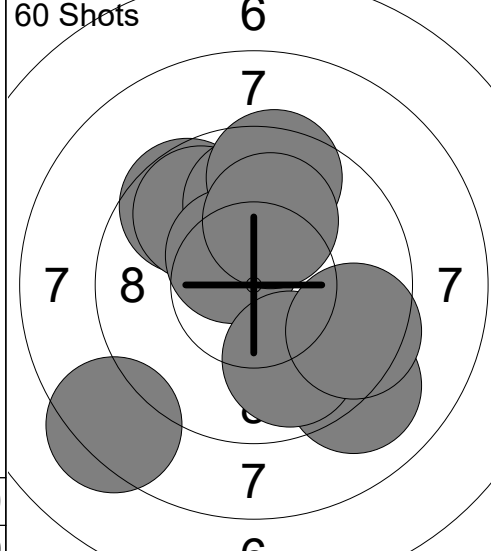
<p>60 Shots</p>  <p style="text-align: center;">5 6 7 8 7 6 5</p>	<p>1: 8.5 ↘ 2: 8.7 ↙ 3: 6.9 ↖ 4: 8.6 ↗ 5: 9.0 ← 6: 10.2x ↗ 7: 9.8 ↑ 8: 7.2 ↑ 9: 8.8 → 10: 9.3 →</p> <p>Series 87.0</p>	<p>60 Shots 6</p>  <p style="text-align: center;">6 7 8 7</p>	<p>11: 9.6 ↗ 12: 9.8 ↗ 13: 9.9 ↑ 14: 9.5 ↑ 15: 10.5x ↗ 16: 9.1 ↘ 17: 9.8 ↘ 18: 10.1 ↑ 19: 9.5 → 20: 8.3 ↙</p> <p>Series 96.1</p>
87.0		183.1	

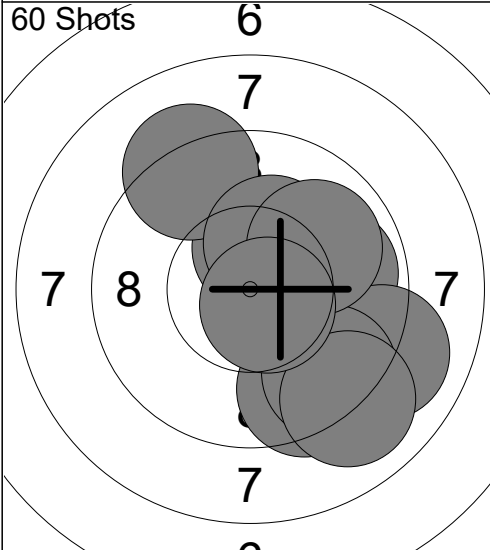
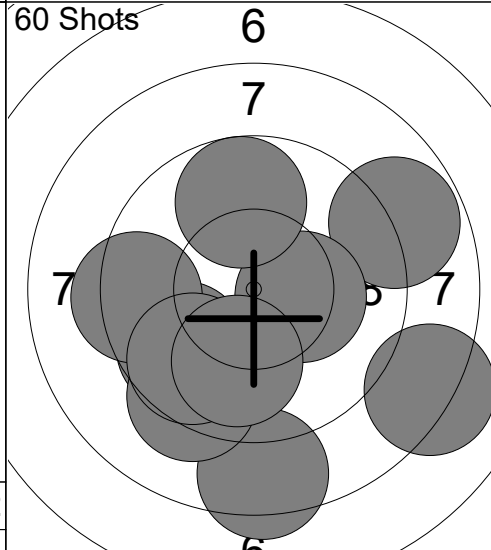
<p>60 Shots 6</p>  <p style="text-align: center;">6 7 8 7</p>	<p>21: 9.9 → 22: 10.4x ↑ 23: 9.2 ↗ 24: 9.5 ↘ 25: 10.3x ↑ 26: 9.0 → 27: 9.4 ↘ 28: 9.0 ↘ 29: 9.9 ↗ 30: 10.6x ↘</p> <p>Series 97.2</p>	<p>60 Shots 6</p>  <p style="text-align: center;">6 7 5 7</p>	<p>31: 9.7 ↙ 32: 8.8 → 33: 8.4 ↓ 34: 9.3 ↘ 35: 10.3x → 36: 9.7 ↑ 37: 8.2 → 38: 9.3 ← 39: 9.7 ↙ 40: 9.9 ↓</p> <p>Series 93.3</p>
280.3		373.6	

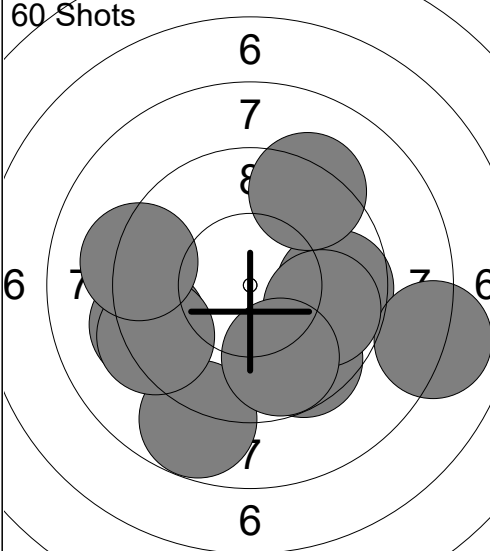
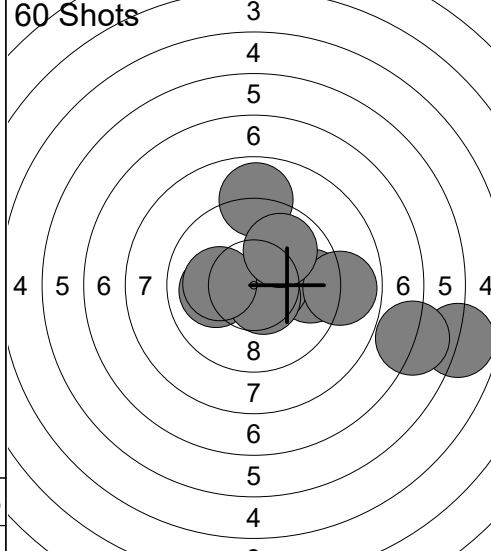
<p>60 Shots 6</p>  <p style="text-align: center;">6 7 8 7 6</p>	<p>41: 8.8 ↓ 42: 9.7 → 43: 9.3 ← 44: 9.3 ← 45: 9.2 ← 46: 9.6 ↘ 47: 8.0 → 48: 9.8 → 49: 9.8 ↓ 50: 9.3 ↗</p> <p>Series 92.8</p>	<p>60 Shots 3</p>  <p style="text-align: center;">3 4 5 6 8 7 6 5 4 3</p>	<p>51: 8.9 ↑ 52: 9.6 → 53: 5.9 → 54: 6.9 → 55: 10.5x → 56: 8.9 → 57: 10.0 ← 58: 10.6x ↘ 59: 10.1 ← 60: 9.9 ↗</p> <p>Series 91.3</p>
466.4		557.7	

Relay 5	Lane 48	BONK Sam
-------------------	-------------------	-----------------

1-80	DARC Precision	Precision
------	----------------	-----------

31.01.2025	2025 AirNats by X Count	Civilian Marksmanship Program
------------	-------------------------	-------------------------------

Comment	Signature
---------	-----------

<p>60 Shots</p>	<p>60 Shots</p>	<p>11: 10.3x ←</p> <p>12: 10.1 ↙</p> <p>13: 9.2 →</p> <p>14: 8.8 →</p> <p>15: 7.3 →</p> <p>16: 7.6 →</p> <p>17: 9.2 ↑</p> <p>18: 8.8 →</p> <p>19: 10.2x ←</p> <p>20: 8.0 →</p> <p>Series 89.5</p>
93.5	183.0	

<p>60 Shots</p>	<p>60 Shots</p>	<p>21: 9.9 ↗</p> <p>22: 10.6x ↗</p> <p>23: 9.6 ↘</p> <p>24: 10.5x ↙</p> <p>25: 10.2x ↙</p> <p>26: 10.0 ↗</p> <p>27: 10.2x ➔</p> <p>28: 9.5 ←</p> <p>29: 9.3 ↗</p> <p>30: 10.0 ↑</p> <p>Series 99.8</p>
282.8	380.6	

<p>60 Shots</p>	<p>60 Shots</p>	<p>31: 10.6x ←</p> <p>32: 10.1 ↗</p> <p>33: 9.1 ←</p> <p>34: 9.6 ↘</p> <p>35: 10.3x ➔</p> <p>36: 10.2x ←</p> <p>37: 10.5x ➔</p> <p>38: 10.3x ←</p> <p>39: 9.2 ↗</p> <p>40: 7.9 ←</p> <p>Series 97.8</p>
469.5	564.9	

<p>60 Shots</p> <p style="text-align: center;">6 7 7 8 7 7</p>	<p>1: 10.3x →</p> <p>2: 10.6x ↑</p> <p>3: 9.9 ↓</p> <p>4: 10.5x →</p> <p>5: 9.9 ↑</p> <p>6: 10.6x ↑</p> <p>7: 10.1 →</p> <p>8: 10.7x ↑</p> <p>9: 10.0 ←</p> <p>10: 10.8x ↖</p> <hr/> <p>Series 103.4</p> <p style="text-align: center;">103.4</p>	<p>60 Shots</p> <p style="text-align: center;">6 7 7 8 7 8 7</p>	<p>11: 9.8 ↑</p> <p>12: 8.7 ↘</p> <p>13: 9.1 ↘</p> <p>14: 10.1 ↘</p> <p>15: 10.5x ↓</p> <p>16: 9.4 →</p> <p>17: 10.9x ↓</p> <p>18: 10.2x ↙</p> <p>19: 10.2x →</p> <p>20: 10.1 ↑</p> <hr/> <p>Series 99.0</p> <p style="text-align: center;">202.4</p>
<p>60 Shots</p> <p style="text-align: center;">6 7 7 8 7 8 7</p>	<p>21: 9.7 →</p> <p>22: 10.7x ↙</p> <p>23: 9.6 ←</p> <p>24: 10.4x ↘</p> <p>25: 10.1 ↘</p> <p>26: 10.1 →</p> <p>27: 10.6x ↑</p> <p>28: 10.8x →</p> <p>29: 10.5x ↑</p> <p>30: 9.9 ↑</p> <hr/> <p>Series 102.4</p> <p style="text-align: center;">304.8</p>	<p>60 Shots</p> <p style="text-align: center;">6 7 7 8 7 8 7</p>	<p>31: 9.8 ↙</p> <p>32: 10.4x →</p> <p>33: 8.8 →</p> <p>34: 10.0 →</p> <p>35: 10.4x ↘</p> <p>36: 10.0 →</p> <p>37: 10.5x ↑</p> <p>38: 9.7 ↖</p> <p>39: 9.3 ↙</p> <p>40: 9.9 →</p> <hr/> <p>Series 98.8</p> <p style="text-align: center;">403.6</p>
<p>60 Shots</p> <p style="text-align: center;">6 7 7 8 7 8 7 6</p>	<p>41: 10.4x →</p> <p>42: 8.5 ←</p> <p>43: 10.7x ↑</p> <p>44: 10.1 ←</p> <p>45: 10.0 →</p> <p>46: 9.7 ←</p> <p>47: 10.6x ↖</p> <p>48: 10.2x ↘</p> <p>49: 10.2x ↑</p> <p>50: 10.2x ↘</p> <hr/> <p>Series 100.6</p> <p style="text-align: center;">504.2</p>	<p>60 Shots</p> <p style="text-align: center;">6 7 7 8 7 8 7 6</p>	<p>51: 9.8 ↖</p> <p>52: 10.0 ↘</p> <p>53: 10.8x ↙</p> <p>54: 9.7 →</p> <p>55: 10.7x ↙</p> <p>56: 10.3x →</p> <p>57: 10.2x →</p> <p>58: 9.8 ↘</p> <p>59: 10.2x ↖</p> <p>60: 10.6x ↑</p> <hr/> <p>Series 102.1</p> <p style="text-align: center;">606.3</p>

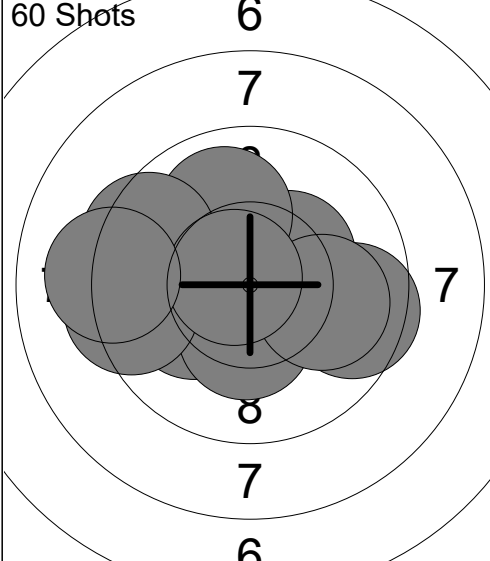
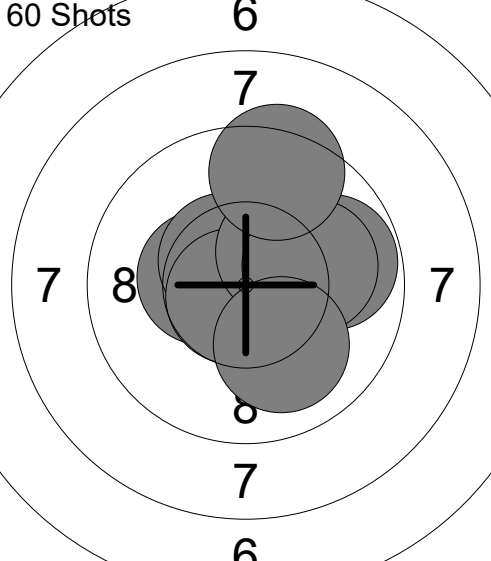
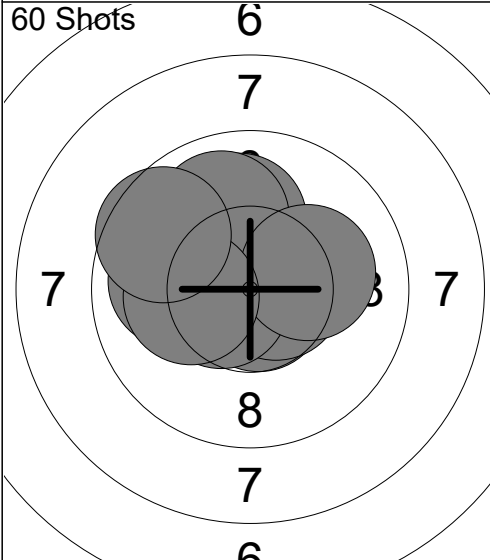
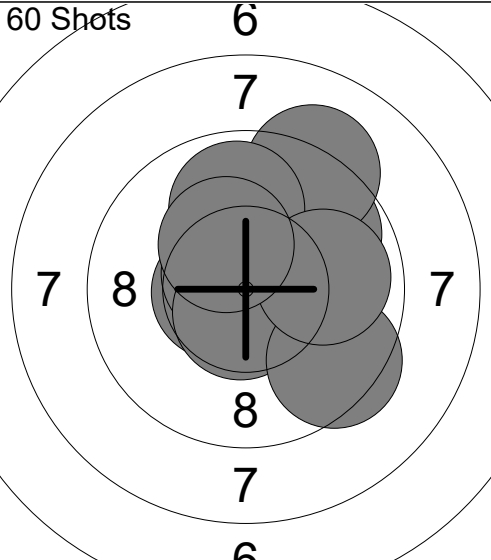
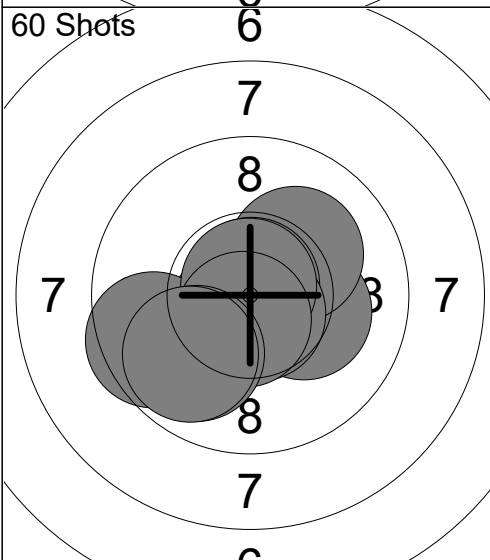
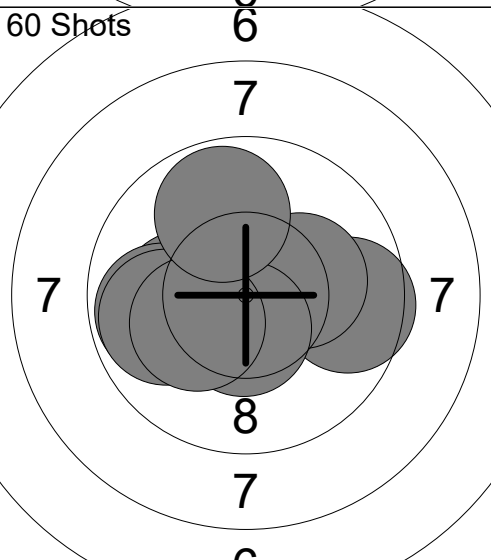
<p>60 Shots</p> 	<p>1: 10.1 ← 2: 10.3x ↗ 3: 9.6 → 4: 10.0 ↑ 5: 9.5 ← 6: 10.3x ↓ 7: 9.4 ← 8: 10.0 → 9: 10.7x ↙ 10: 9.1 ←</p> <p>Series 99.0 99.0</p>	<p>60 Shots</p> 	<p>11: 10.7x → 12: 10.5x ↑ 13: 10.4x ← 14: 10.5x ↖ 15: 10.7x ↙ 16: 10.3x ↗ 17: 9.8 → 18: 10.1 → 19: 9.4 ↑ 20: 10.0 ↓</p> <p>Series 102.4 201.4</p>
<p>60 Shots</p> 	<p>21: 10.7x ↓ 22: 10.0 ↑ 23: 10.0 ← 24: 10.8x ↑ 25: 10.6x → 26: 10.5x ← 27: 9.9 ↑ 28: 10.2x → 29: 10.2x ← 30: 9.6 ↖</p> <p>Series 102.5 303.9</p>	<p>60 Shots</p> 	<p>31: 10.6x ← 32: 10.8x ↓ 33: 9.8 ↗ 34: 9.2 ↑ 35: 9.9 ↑ 36: 10.6x ↖ 37: 10.6x ↓ 38: 9.4 ↘ 39: 9.9 → 40: 10.3x ↖</p> <p>Series 101.1 405.0</p>
<p>60 Shots</p> 	<p>41: 10.6x ↙ 42: 9.5 ← 43: 10.2x → 44: 10.1 ↗ 45: 10.8x ↑ 46: 10.7x ↓ 47: 10.8x ↑ 48: 10.6x ↓ 49: 9.9 ↙ 50: 9.8 ↙</p> <p>Series 103.0 508.0</p>	<p>60 Shots</p> 	<p>51: 9.6 → 52: 10.8x ↓ 53: 10.2x ← 54: 10.6x ↖ 55: 10.2x → 56: 10.5x ↓ 57: 9.8 ← 58: 9.9 ← 59: 10.2x ↙ 60: 9.8 ↑</p> <p>Series 101.6 609.6</p>

<p>60 Shots</p>	<p>1: 10.0 ↙ 2: 10.8x ↓ 3: 10.0 → 4: 9.8 ↓ 5: 10.7x ↗ 6: 10.4x ↙ 7: 10.2x ↑ 8: 10.0 ↓ 9: 10.3x → 10: 10.6x ↖</p> <p>Series 102.8 102.8</p>	<p>60 Shots</p>	<p>11: 10.4x ↓ 12: 10.0 → 13: 10.4x ↙ 14: 10.6x ↑ 15: 9.8 → 16: 10.4x ↑ 17: 10.6x ↑ 18: 10.1 ↗ 19: 10.1 → 20: 9.8 →</p> <p>Series 102.2 205.0</p>
<p>60 Shots</p>	<p>21: 10.1 ↖ 22: 10.0 ↑ 23: 10.4x ← 24: 10.4x ↗ 25: 10.5x ← 26: 10.3x → 27: 10.5x ← 28: 10.5x ↑ 29: 9.9 ← 30: 10.6x ↑</p> <p>Series 103.2 308.2</p>	<p>60 Shots</p>	<p>31: 10.5x → 32: 10.3x ← 33: 10.8x ← 34: 10.7x → 35: 10.6x → 36: 10.4x ↓ 37: 10.4x ↑ 38: 9.7 ↑ 39: 10.6x ↖ 40: 10.7x →</p> <p>Series 104.7 412.9</p>
<p>60 Shots</p>	<p>41: 10.4x ↑ 42: 10.7x ↓ 43: 10.6x ↑ 44: 9.9 → 45: 10.6x ↖ 46: 10.2x ↗ 47: 10.5x ↑ 48: 10.3x ↖ 49: 10.5x → 50: 10.3x ↘</p> <p>Series 104.0 516.9</p>	<p>60 Shots</p>	<p>51: 10.9x ↙ 52: 10.7x ↓ 53: 10.2x ↑ 54: 9.8 ← 55: 10.4x → 56: 10.6x ↘ 57: 10.4x ↖ 58: 10.4x ↘ 59: 9.8 ↖ 60: 10.5x ↘</p> <p>Series 103.7 620.6</p>

<p>60 Shots</p>	<p>1: 10.0 →</p> <p>2: 10.1 ↗</p> <p>3: 10.2x ←</p> <p>4: 10.6x ↗</p> <p>5: 9.8 ←</p> <p>6: 10.5x ↑</p> <p>7: 10.7x ↖</p> <p>8: 9.8 ↗</p> <p>9: 10.2x ↖</p> <p>10: 10.4x ←</p> <hr/> <p>Series 102.3</p>	<p>60 Shots</p>	<p>11: 10.7x ↙</p> <p>12: 10.5x ↓</p> <p>13: 10.3x ↓</p> <p>14: 10.4x ↖</p> <p>15: 9.9 ↗</p> <p>16: 10.4x ↖</p> <p>17: 10.1 ↓</p> <p>18: 10.1 ↓</p> <p>19: 10.3x ↑</p> <p>20: 10.5x ↓</p> <hr/> <p>Series 103.2</p>
102.3		205.5	
<p>60 Shots</p>	<p>21: 9.5 ↖</p> <p>22: 10.1 ↑</p> <p>23: 10.8x ↑</p> <p>24: 10.1 ↖</p> <p>25: 10.1 ↓</p> <p>26: 9.9 ↑</p> <p>27: 10.4x ↓</p> <p>28: 10.0 →</p> <p>29: 10.5x ↗</p> <p>30: 10.0 ↓</p> <hr/> <p>Series 101.4</p>	<p>60 Shots</p>	<p>31: 10.7x ↖</p> <p>32: 10.3x ⇒</p> <p>33: 10.5x ↗</p> <p>34: 10.1 ↖</p> <p>35: 9.7 ↗</p> <p>36: 10.1 ↑</p> <p>37: 9.9 ↓</p> <p>38: 10.4x ↓</p> <p>39: 10.5x ↓</p> <p>40: 10.4x ↓</p> <hr/> <p>Series 102.6</p>
306.9		409.5	
<p>60 Shots</p>	<p>41: 9.7 →</p> <p>42: 9.5 ↙</p> <p>43: 10.2x ↓</p> <p>44: 9.4 →</p> <p>45: 10.7x ⇒</p> <p>46: 10.6x ↓</p> <p>47: 9.4 ↓</p> <p>48: 10.4x ↙</p> <p>49: 10.3x ←</p> <p>50: 10.4x ↓</p> <hr/> <p>Series 100.6</p>	<p>60 Shots</p>	<p>51: 10.4x ←</p> <p>52: 10.3x ↓</p> <p>53: 9.3 →</p> <p>54: 10.1 ↗</p> <p>55: 10.4x ↙</p> <p>56: 9.8 ↓</p> <p>57: 10.5x ↗</p> <p>58: 10.8x ←</p> <p>59: 10.5x ↑</p> <p>60: 10.2x ↓</p> <hr/> <p>Series 102.3</p>
510.1		612.4	

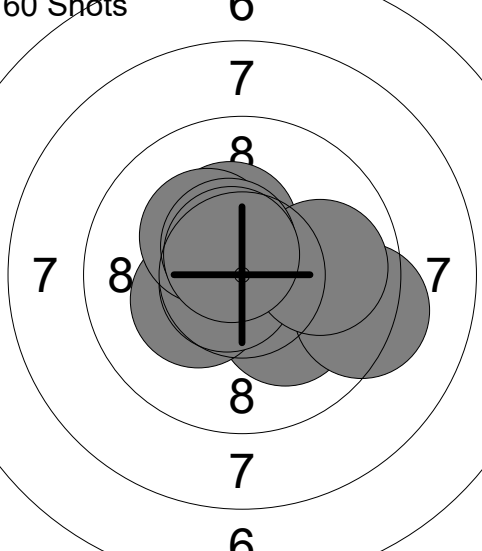
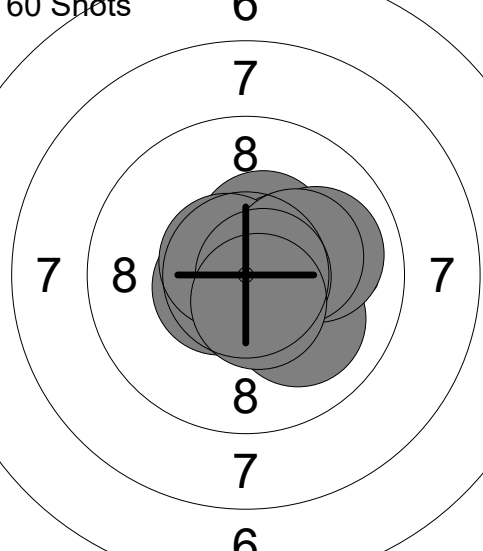
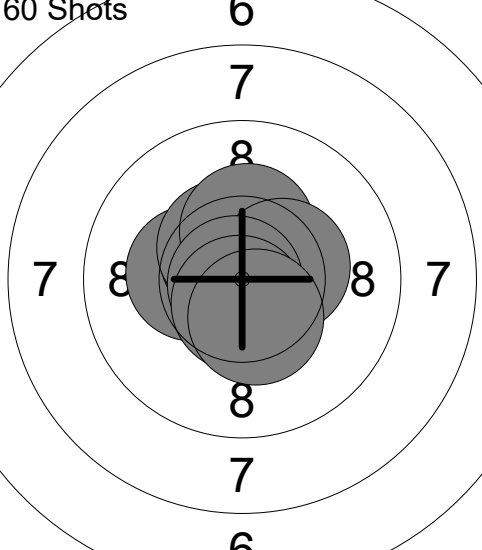
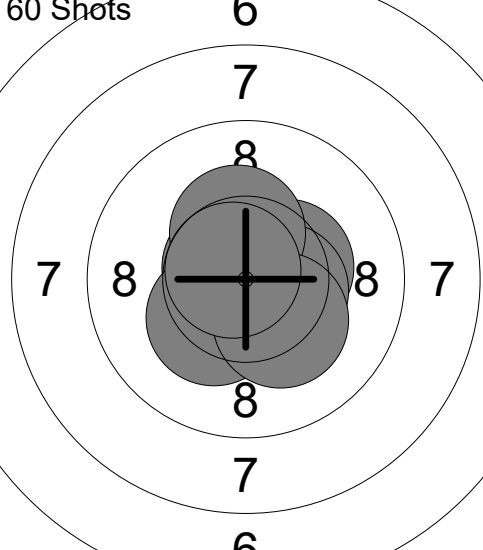
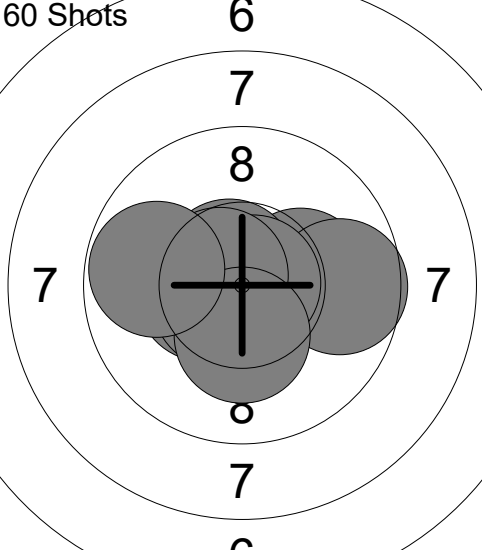
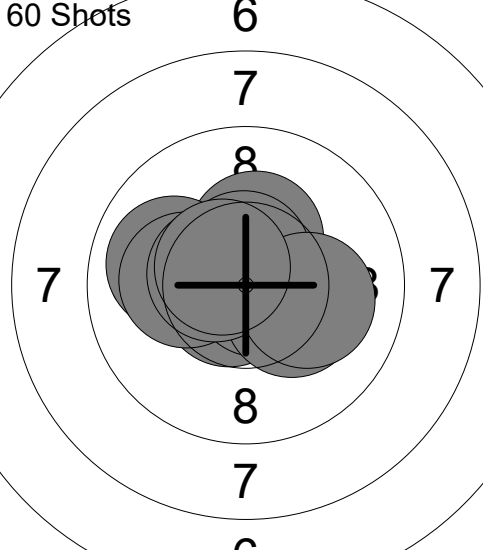
<p>60 Shots</p>  <p style="text-align: center;">6 7 8 7 8 7</p>	<p>1: 10.7x →</p> <p>2: 10.1 ↘</p> <p>3: 10.3x ↙</p> <p>4: 10.7x ↙</p> <p>5: 10.3x ↑</p> <p>6: 10.3x ↗</p> <p>7: 9.3 →</p> <p>8: 9.9 →</p> <p>9: 10.5x ↗</p> <p>10: 10.6x ↗</p> <hr/> <p>Series 102.7</p> <hr/> <p style="text-align: center;">102.7</p>	<p>60 Shots</p>  <p style="text-align: center;">6 7 8 7 8 7</p>	<p>11: 10.4x ↗</p> <p>12: 10.4x →</p> <p>13: 10.0 ↘</p> <p>14: 10.9x ↘</p> <p>15: 10.6x ↙</p> <p>16: 10.6x ↖</p> <p>17: 10.0 →</p> <p>18: 10.3x →</p> <p>19: 10.7x →</p> <p>20: 10.6x ↘</p> <hr/> <p>Series 104.5</p> <hr/> <p style="text-align: center;">207.2</p>
<p>60 Shots</p>  <p style="text-align: center;">6 6 7 8 7 8 7</p>	<p>21: 10.3x ↙</p> <p>22: 10.9x ↗</p> <p>23: 10.6x ↗</p> <p>24: 10.5x ↗</p> <p>25: 10.6x ↗</p> <p>26: 10.3x ↑</p> <p>27: 10.4x →</p> <p>28: 10.8x ↙</p> <p>29: 10.6x ↓</p> <p>30: 10.4x ↓</p> <hr/> <p>Series 105.4</p> <hr/> <p style="text-align: center;">312.6</p>	<p>60 Shots</p>  <p style="text-align: center;">6 6 7 8 7 8 7</p>	<p>31: 10.7x ↓</p> <p>32: 10.4x →</p> <p>33: 10.8x ↘</p> <p>34: 10.7x ↖</p> <p>35: 10.5x →</p> <p>36: 10.3x ↑</p> <p>37: 10.6x ↙</p> <p>38: 10.3x ↙</p> <p>39: 10.2x ↘</p> <p>40: 10.7x ↖</p> <hr/> <p>Series 105.2</p> <hr/> <p style="text-align: center;">417.8</p>
<p>60 Shots</p>  <p style="text-align: center;">6 6 7 8 7 8 7</p>	<p>41: 10.9x ↙</p> <p>42: 10.4x ↙</p> <p>43: 10.2x →</p> <p>44: 10.7x ↖</p> <p>45: 10.6x ↙</p> <p>46: 9.7 →</p> <p>47: 10.8x →</p> <p>48: 10.6x ↖</p> <p>49: 10.3x ↓</p> <p>50: 9.8 ↖</p> <hr/> <p>Series 104.0</p> <hr/> <p style="text-align: center;">521.8</p>	<p>60 Shots</p>  <p style="text-align: center;">6 6 7 8 7 8 7</p>	<p>51: 10.7x ↙</p> <p>52: 10.8x →</p> <p>53: 10.3x ↑</p> <p>54: 10.6x ↑</p> <p>55: 10.0 ↖</p> <p>56: 10.3x →</p> <p>57: 10.2x ↖</p> <p>58: 10.5x ↖</p> <p>59: 10.1 →</p> <p>60: 10.6x ↖</p> <hr/> <p>Series 104.1</p> <hr/> <p style="text-align: center;">625.9</p>

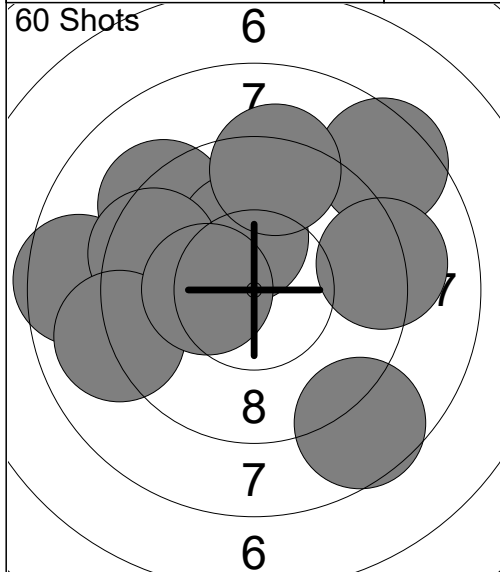

1:	8.5	↗
2:	9.3	↖
3:	8.5	←
4:	10.2x	↑
5:	9.2	→
6:	9.5	↖
7:	8.6	↘
8:	9.3	↑
9:	9.0	←
10:	10.3x	←
Series		92.4
		92.4

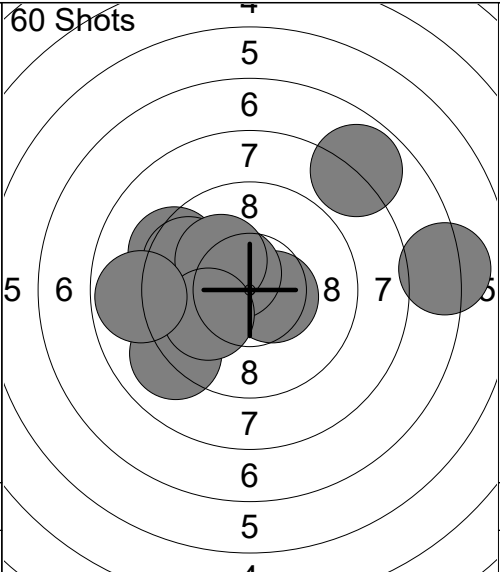

11:	7.1	→
12:	9.3	↖
13:	9.6	↖
14:	10.5x	→
15:	10.5x	↖
16:	9.1	↖
17:	10.2x	↖
18:	7.8	↗
19:	10.0	←
20:	8.8	←
Series		92.9
		185.3

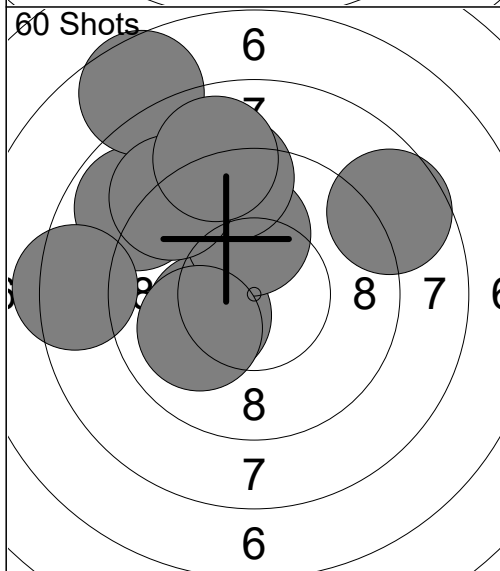

21:	10.2x	←
22:	10.1	↑
23:	9.2	↑
24:	10.0	←
25:	8.9	↖
26:	8.4	←
27:	7.6	↗
28:	9.1	↗
29:	8.7	↗
30:	8.9	↑
Series		91.1
		276.4

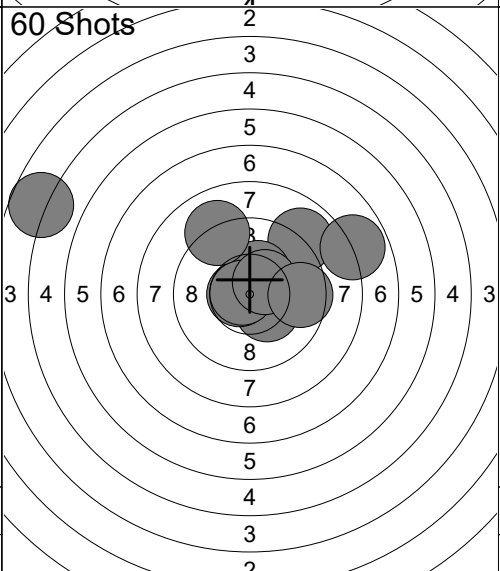

31:	4.7	↖
32:	10.3x	↘
33:	8.9	↗
34:	10.3x	↑
35:	10.7x	←
36:	7.8	↗
37:	10.7x	←
38:	10.4x	↗
39:	9.0	↗
40:	9.5	→
Series		92.3
		368.7

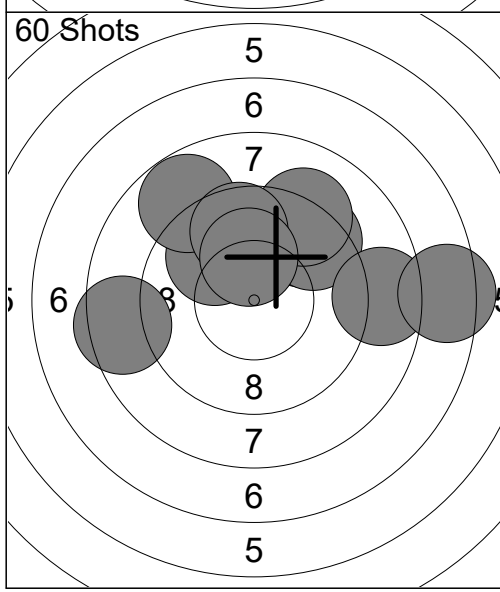

41:	9.9	↖
42:	8.5	←
43:	9.5	↗
44:	9.4	↗
45:	8.8	↖
46:	9.2	↗
47:	9.6	↑
48:	10.1	↑
49:	8.6	→
50:	7.4	→
Series		91.0
		459.7

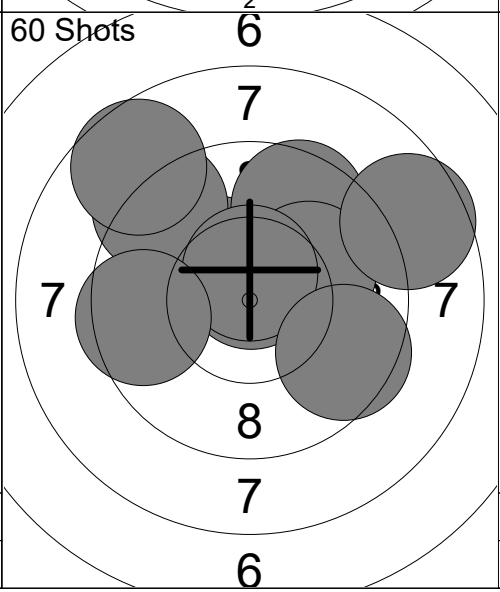

51:	10.3x	↖
52:	10.7x	↑
53:	9.6	↗
54:	10.1	↗
55:	9.2	↖
56:	10.6x	↑
57:	8.7	↖
58:	9.5	↘
59:	8.6	↗
60:	9.5	←
Series		96.8
		556.5

Relay 5	Lane 56	ZHOU Angel Jiajia
-------------------	-------------------	--------------------------

1-80	Culver Academy	Precision	
------	----------------	-----------	--

31.01.2025	2025 AirNats by X Count	Civilian Marksmanship Program	
------------	-------------------------	-------------------------------	--

Comment	Signature		
---------	-----------	--	--

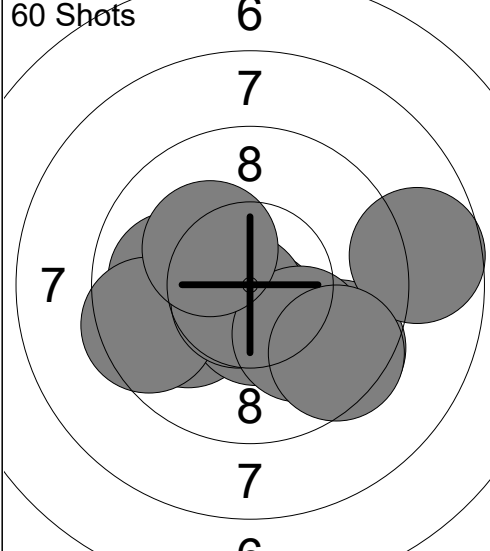
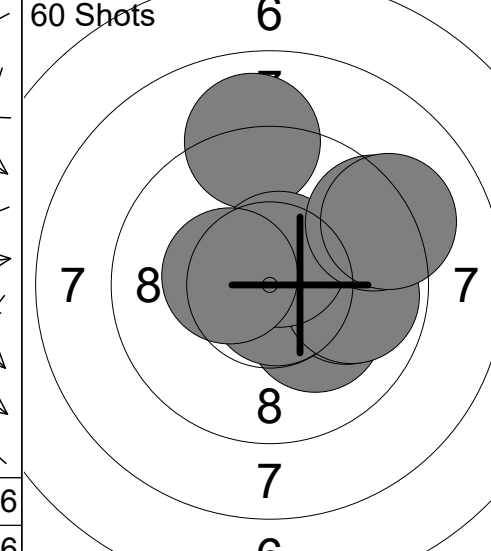
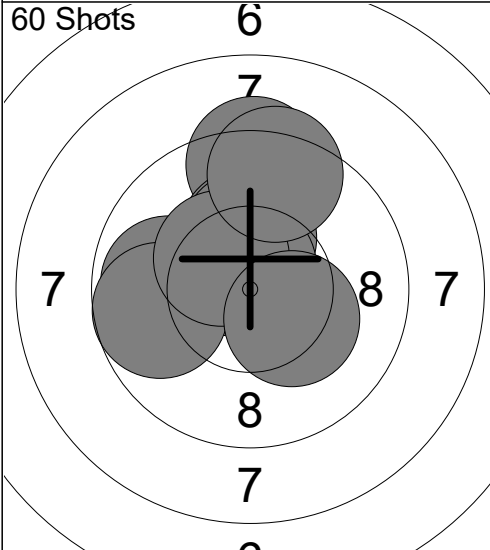
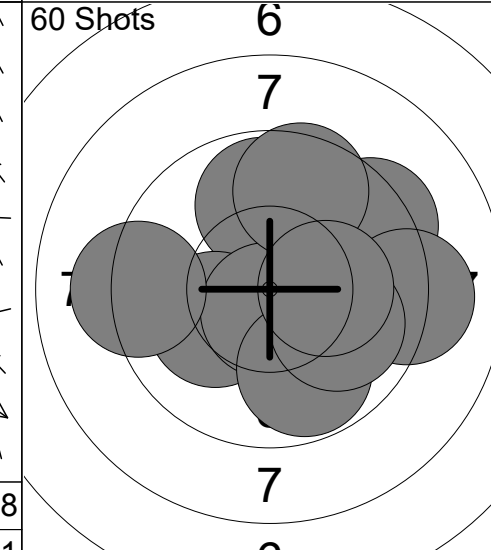
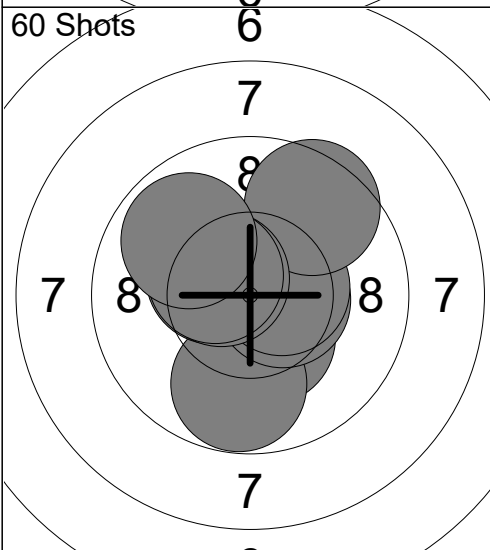
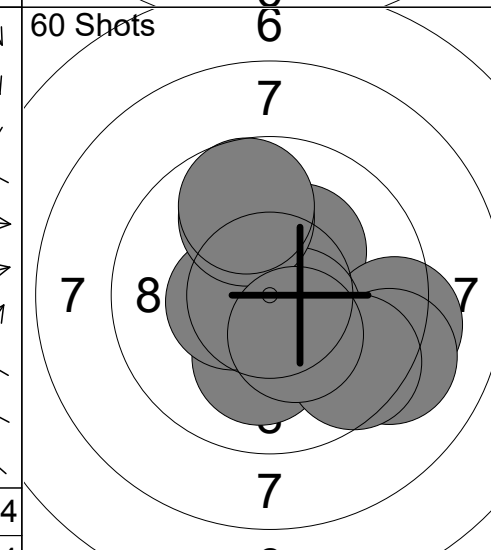
<p>60 Shots</p>  <p style="text-align: center;">6 7 8 7 8 7</p>	<p>1: 10.0 ↙ 2: 10.5x ↓ 3: 10.0 ← 4: 9.5 ↘ 5: 9.5 ← 6: 8.7 → 7: 10.7x ↙ 8: 10.0 ↘ 9: 9.5 ↘ 10: 10.2x ↗</p> <p>Series 98.6</p>	<p>60 Shots</p>  <p style="text-align: center;">6 7 8 7 8 7</p>	<p>11: 9.0 ↑ 12: 10.2x ↘ 13: 10.4x → 14: 9.9 → 15: 10.8x ↓ 16: 9.9 → 17: 10.6x ↑ 18: 10.4x ← 19: 9.3 ↗ 20: 9.2 ↗</p> <p>Series 99.7</p>
	98.6		198.3
<p>60 Shots</p>  <p style="text-align: center;">6 7 8 7 8 7</p>	<p>21: 9.3 ↑ 22: 10.2x ↑ 23: 10.3x ↑ 24: 10.6x ↗ 25: 9.9 ← 26: 10.7x ↑ 27: 9.7 ← 28: 10.4x ↗ 29: 10.3x ↘ 30: 9.4 ↑</p> <p>Series 100.8</p>	<p>60 Shots</p>  <p style="text-align: center;">6 7 8 7 8 7</p>	<p>31: 9.8 ↑ 32: 9.4 ↗ 33: 10.1 ← 34: 9.1 → 35: 10.7x ↓ 36: 9.2 ← 37: 9.8 ↓ 38: 9.6 ↑ 39: 10.0 ↘ 40: 10.2x →</p> <p>Series 97.9</p>
	299.1		397.0
<p>60 Shots</p>  <p style="text-align: center;">6 7 8 7 8 7</p>	<p>41: 10.5x ↓ 42: 10.4x ↓ 43: 9.8 ↓ 44: 10.4x ↖ 45: 10.5x → 46: 10.5x → 47: 9.5 ↗ 48: 10.5x ↖ 49: 10.4x ↖ 50: 9.9 ↖</p> <p>Series 102.4</p>	<p>60 Shots</p>  <p style="text-align: center;">6 7 8 7 8 7</p>	<p>51: 10.3x ↗ 52: 9.3 → 53: 10.1 ↓ 54: 10.5x ↘ 55: 9.2 ↘ 56: 10.5x ← 57: 9.5 ↘ 58: 9.9 ↑ 59: 9.7 ↑ 60: 10.3x ↘</p> <p>Series 99.3</p>
	499.4		598.7

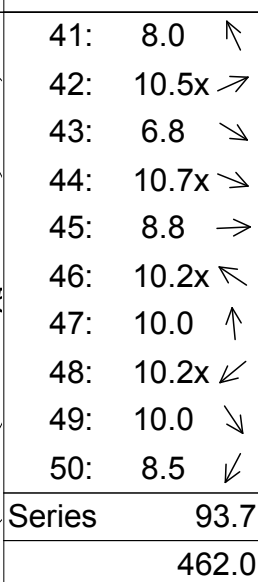
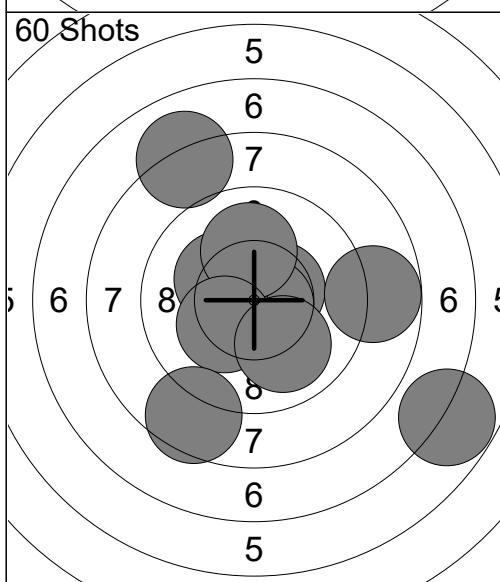
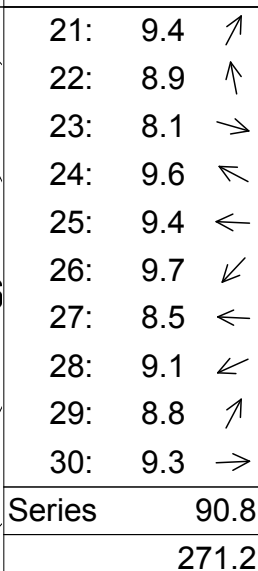
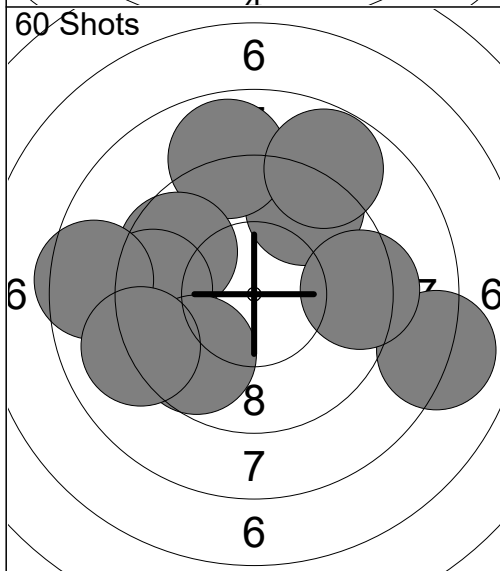
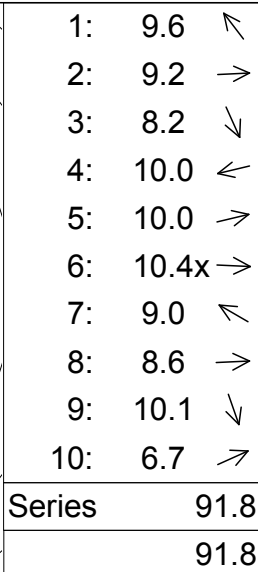
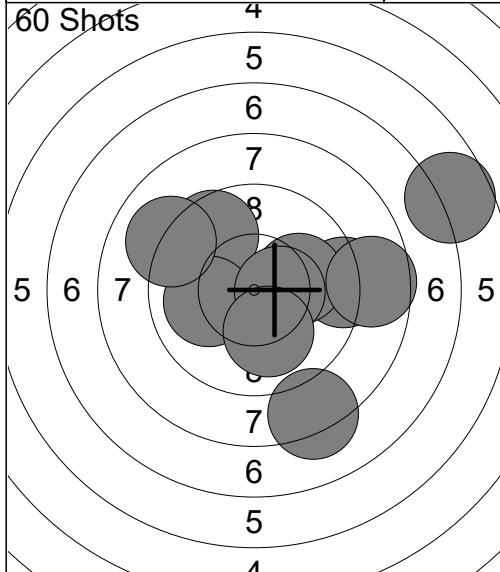

Relay **5** Lane **58** **SHI Samuel Zhenhe**

1-80 Culver Academy Precision

31.01.2025 2025 AirNats by X Count Civilian Marksmanship Program

Comment Signature

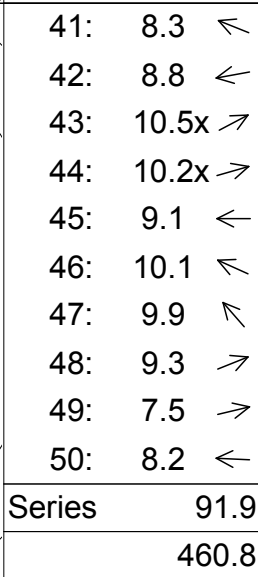
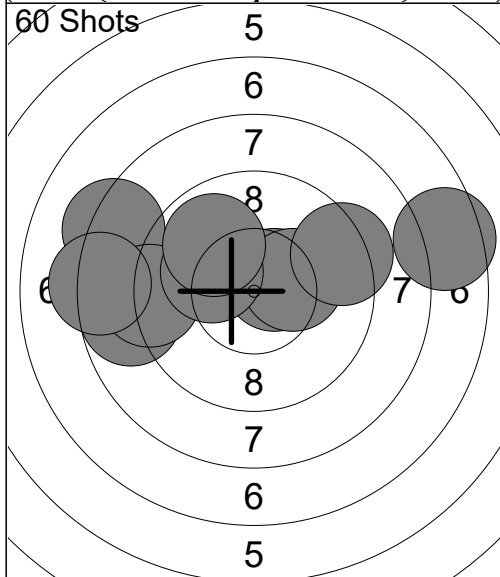
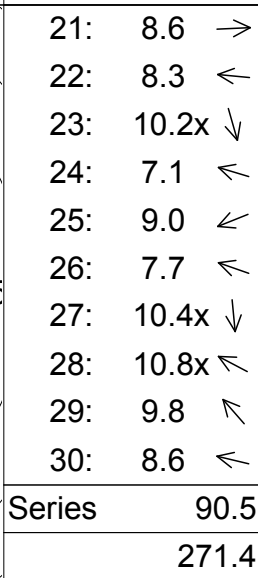
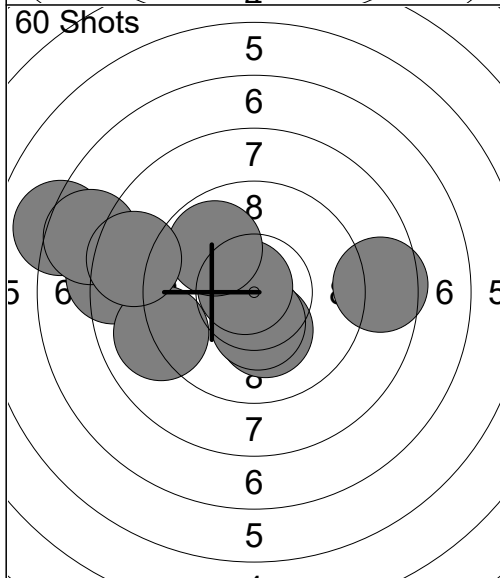
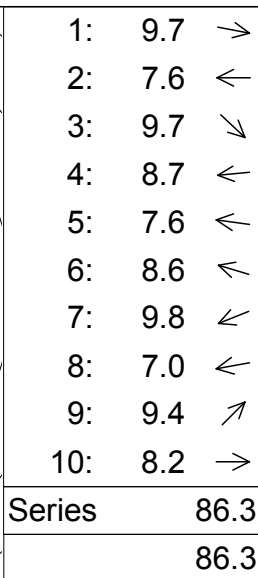
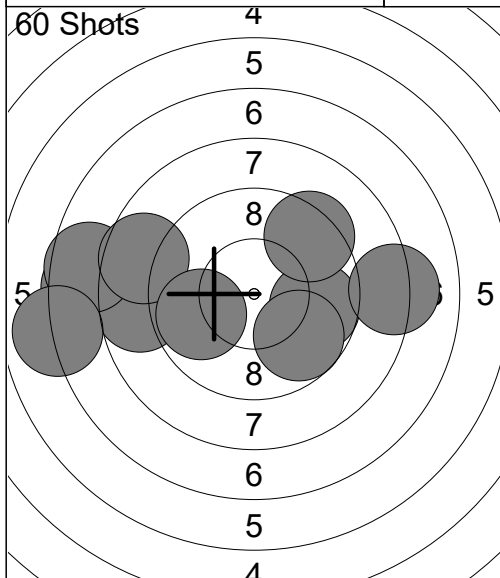

Relay 5	Lane 59	LI Leon Leyao
-------------------	-------------------	----------------------

1-80	Culver Academy	Precision	
------	----------------	-----------	--

31.01.2025	2025 AirNats by X Count	Civilian Marksmanship Program	
------------	-------------------------	-------------------------------	--

Comment	Signature		
---------	-----------	--	--

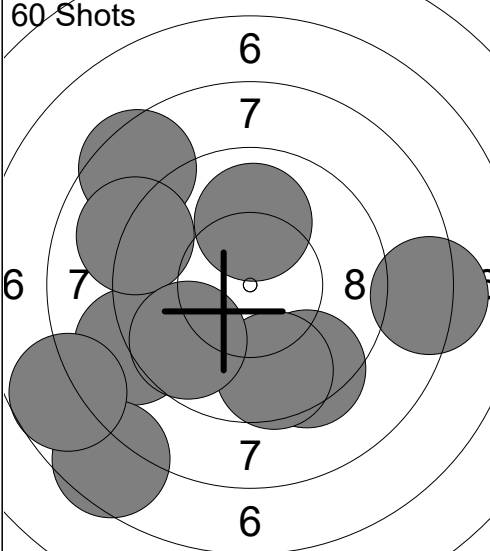
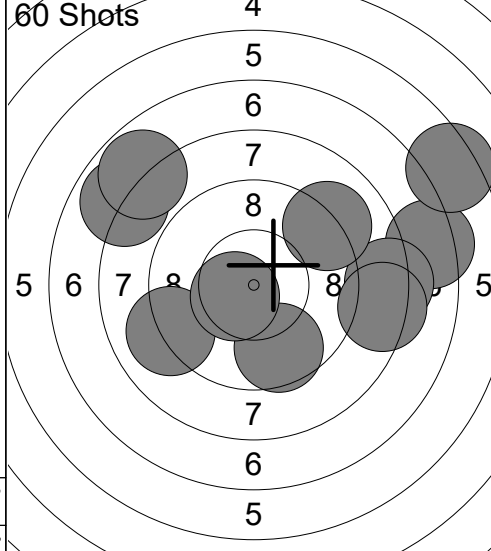
<p>60 Shots</p>  <p style="text-align: center;">6 7 6 7 8 6 7 6</p>	<p>1: 8.2 → 2: 9.4 ↓ 3: 8.9 ← 4: 7.6 ↓ 5: 7.7 ← 6: 10.0 ↑ 7: 8.5 ↗ 8: 9.1 ↖ 9: 9.6 ↓ 10: 9.7 ↙</p> <p>Series 88.7 88.7</p>	<p>60 Shots</p>  <p style="text-align: center;">4 5 6 7 8 5 6 7 8 5 7 6 5</p>	<p>11: 7.3 → 12: 8.2 → 13: 7.9 ↖ 14: 8.3 → 15: 6.4 ↗ 16: 9.1 ↗ 17: 7.8 ↖ 18: 9.6 ↓ 19: 9.0 ← 20: 10.5x ↙</p> <p>Series 84.1 172.8</p>
---	--	---	---

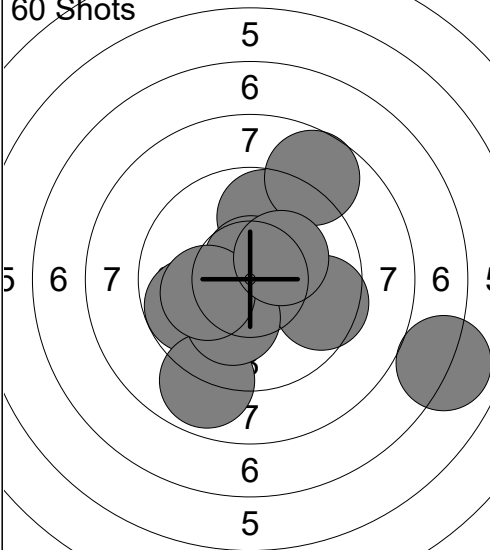
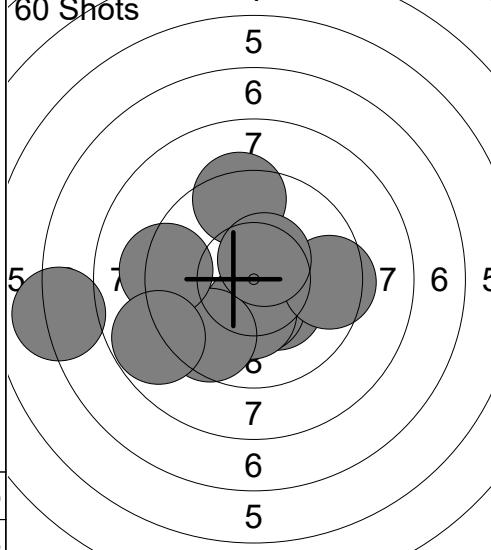
<p>60 Shots</p>  <p style="text-align: center;">5 6 7 5 6 7 7 6 5 7 6 5</p>	<p>21: 9.7 ← 22: 9.5 → 23: 9.8 ↑ 24: 8.9 ↓ 25: 10.6x ↑ 26: 7.0 → 27: 10.1 ↓ 28: 8.7 ↗ 29: 10.1 ← 30: 10.2x ↗</p> <p>Series 94.6 267.4</p>	<p>60 Shots</p>  <p style="text-align: center;">4 5 6 7 5 7 7 6 5 6 7 6 5</p>	<p>31: 7.1 ← 32: 10.3x ↓ 33: 10.4x ↓ 34: 10.3x ↓ 35: 9.4 ↑ 36: 9.6 ↓ 37: 9.5 → 38: 9.2 ← 39: 10.5x ↑ 40: 8.8 ←</p> <p>Series 95.1 362.5</p>
--	---	--	---

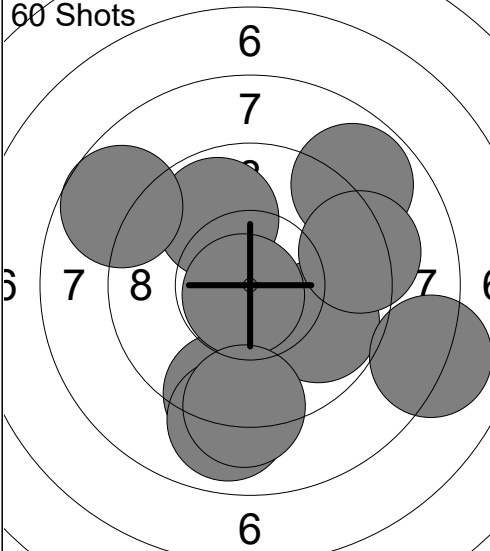
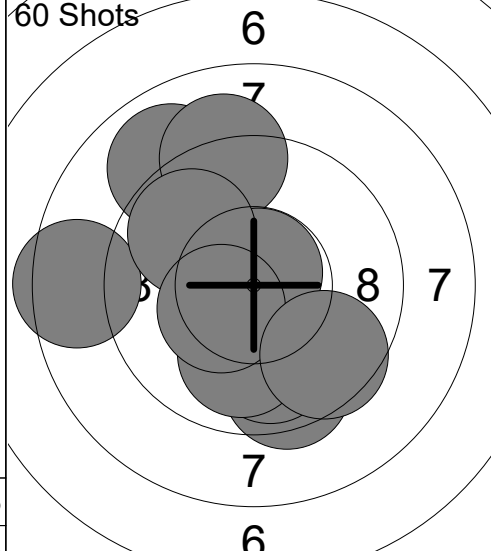
<p>60 Shots</p>  <p style="text-align: center;">6 7 6 7 8 7 6 7 6</p>	<p>41: 9.9 ↗ 42: 9.3 ↓ 43: 8.9 ↓ 44: 9.8 → 45: 8.8 ↗ 46: 8.7 ↖ 47: 10.8x ↓ 48: 9.2 ↓ 49: 8.1 → 50: 9.3 →</p> <p>Series 92.8 455.3</p>	<p>60 Shots</p>  <p style="text-align: center;">4 6 7 5 7 8 7 7 6</p>	<p>51: 9.5 ↓ 52: 9.9 ↓ 53: 8.9 ↗ 54: 9.1 ↑ 55: 10.8x ↑ 56: 8.5 ← 57: 9.8 ↖ 58: 10.0 ↓ 59: 10.4x ↙ 60: 9.6 ↓</p> <p>Series 96.5 551.8</p>
---	---	---	--

<p>60 Shots</p>	<p>1: 9.8 ↑ 2: 6.6 → 3: 9.9 ↓ 4: 8.9 ↓ 5: 8.7 ↘ 6: 7.4 ↓ 7: 9.0 ↓ 8: 9.8 → 9: 9.5 ↓ 10: 7.8 ↓</p> <p>Series 81 (0x) 81 (0x)</p>	<p>60 Shots</p>	<p>11: 10.8x ↘ 12: 9.9 ↓ 13: 9.4 ← 14: 8.8 ↗ 15: 8.6 ↓ 16: 10.6x ↘ 17: 9.4 ↑ 18: 9.7 ↑ 19: 8.1 ↗ 20: 7.8 ↓</p> <p>Series 87 (2x) 168 (2x)</p>
<p>60 Shots</p>	<p>21: 9.7 ↘ 22: 9.3 ↓ 23: 9.0 ↑ 24: 8.6 ↘ 25: 9.7 ↗ 26: 9.6 ↓ 27: 8.7 ↑ 28: 7.6 ← 29: 9.6 ↓ 30: 10.2 ↑</p> <p>Series 87 (0x) 255 (2x)</p>	<p>60 Shots</p>	<p>31: 8.9 ↑ 32: 9.5 ← 33: 10.2 ↗ 34: 10.2 ↓ 35: 8.8 ← 36: 7.8 ← 37: 10.3 ↘ 38: 7.5 ↗ 39: 7.5 ↓ 40: 9.0 ↓</p> <p>Series 85 (0x) 340 (2x)</p>
<p>60 Shots</p>	<p>41: 9.1 ↗ 42: 9.2 ← 43: 8.9 ↓ 44: 7.6 ↗ 45: 9.4 ↗ 46: 6.9 ↓ 47: 8.5 ← 48: 9.4 ↑ 49: 7.6 ↗ 50: 9.0 ←</p> <p>Series 81 (0x) 421 (2x)</p>	<p>60 Shots</p>	<p>51: 7.9 ↑ 52: 10.7x → 53: 8.8 ← 54: 10.2 ← 55: 9.9 ← 56: 8.3 ↗ 57: 10.1 ↓ 58: 9.6 → 59: 8.3 ← 60: 9.0 ↓</p> <p>Series 88 (1x) 509 (3x)</p>

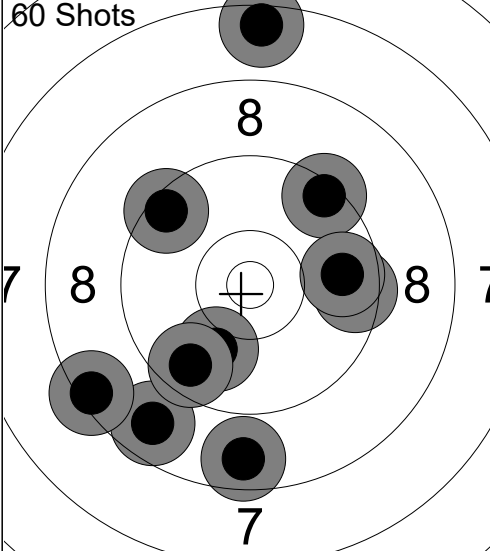
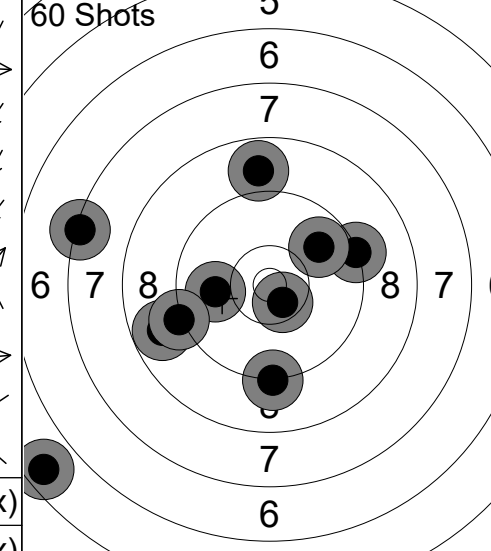
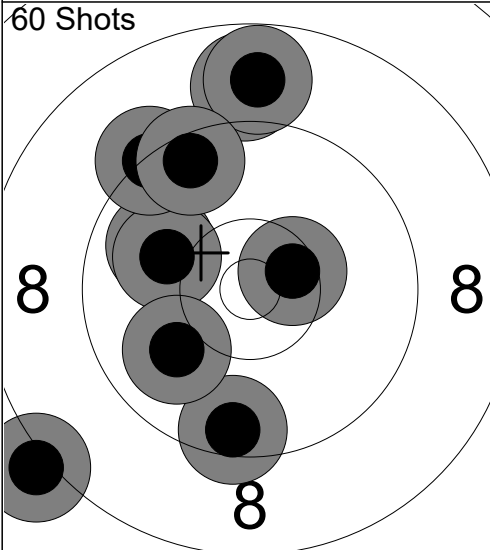
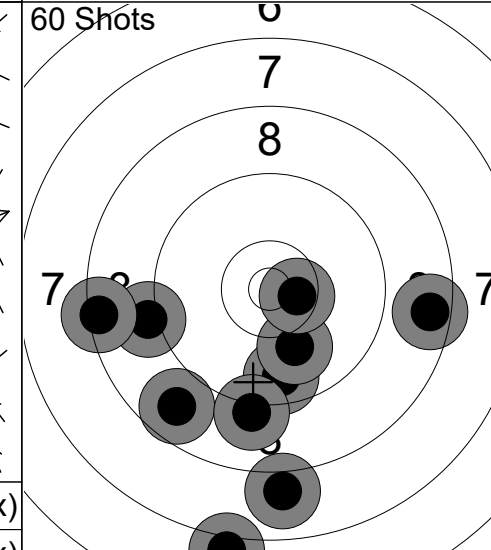
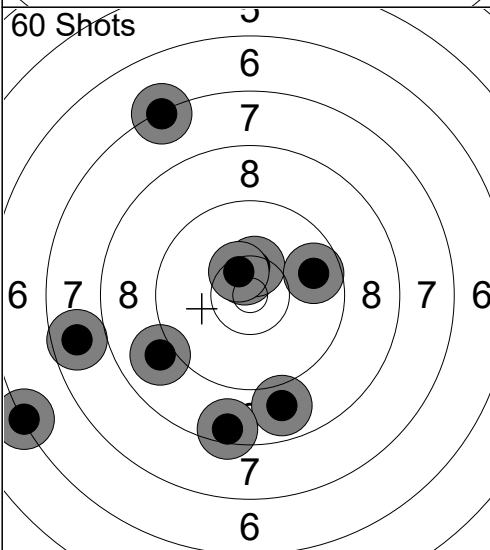
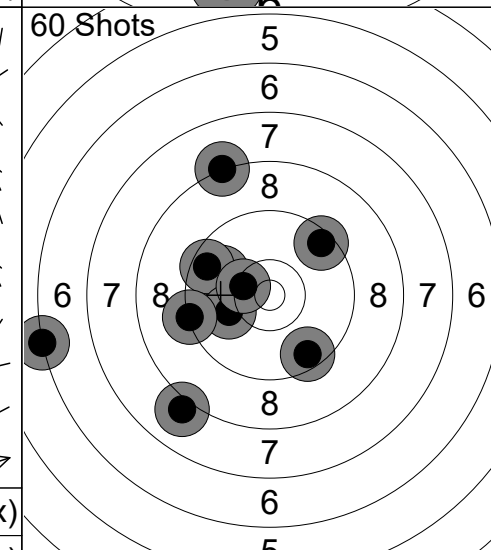
<p>60 Shots</p>  <p style="text-align: center;">7 8 7</p>	<p>1: 8.6 ↓</p> <p>2: 9.5 →</p> <p>3: 8.7 ↓</p> <p>4: 10.0 ↓</p> <p>5: 9.6 ↓</p> <p>6: 9.4 ↗</p> <p>7: 7.5 ↑</p> <p>8: 9.7 →</p> <p>9: 8.4 ←</p> <p>10: 9.5 ↖</p> <hr/> <p>Series 86 (0x)</p> <p style="text-align: center;">86 (0x)</p>	<p>60 Shots</p>  <p style="text-align: center;">6 7 6</p>	<p>11: 8.8 ←</p> <p>12: 9.2 ↓</p> <p>13: 9.3 →</p> <p>14: 8.8 ↑</p> <p>15: 9.9 ←</p> <p>16: 9.2 ←</p> <p>17: 7.3 ↖</p> <p>18: 10.5x ↓</p> <p>19: 9.8 ↗</p> <p>20: 5.6 ←</p> <hr/> <p>Series 83 (1x)</p> <p style="text-align: center;">169 (1x)</p>
<p>60 Shots</p>  <p style="text-align: center;">8 8</p>	<p>21: 8.1 ↖</p> <p>22: 9.9 ↖</p> <p>23: 10.0 ↖</p> <p>24: 9.5 ↓</p> <p>25: 10.5x →</p> <p>26: 8.9 ↑</p> <p>27: 8.8 ↑</p> <p>28: 10.0 ←</p> <p>29: 9.3 ↗</p> <p>30: 9.5 ↑</p> <hr/> <p>Series 90 (1x)</p> <p style="text-align: center;">259 (2x)</p>	<p>60 Shots</p>  <p style="text-align: center;">7 7</p>	<p>31: 9.6 ↓</p> <p>32: 9.1 ←</p> <p>33: 10.0 ↓</p> <p>34: 8.6 →</p> <p>35: 8.7 ↓</p> <p>36: 8.0 ↓</p> <p>37: 8.4 ←</p> <p>38: 7.0 ↓</p> <p>39: 9.1 ↓</p> <p>40: 10.5x →</p> <hr/> <p>Series 86 (1x)</p> <p style="text-align: center;">345 (3x)</p>
<p>60 Shots</p>  <p style="text-align: center;">6 7 6</p>	<p>41: 8.9 ↓</p> <p>42: 9.0 ←</p> <p>43: 10.6x ↑</p> <p>44: 7.3 ↗</p> <p>45: 10.4x ↑</p> <p>46: 10.5x ↗</p> <p>47: 8.5 ↓</p> <p>48: 7.7 ←</p> <p>49: 6.3 ←</p> <p>50: 9.7 →</p> <hr/> <p>Series 84 (3x)</p> <p style="text-align: center;">429 (6x)</p>	<p>60 Shots</p>  <p style="text-align: center;">6 7 6</p>	<p>51: 9.9 ↖</p> <p>52: 9.6 ↖</p> <p>53: 8.0 ↓</p> <p>54: 9.5 ↓</p> <p>55: 10.1 ←</p> <p>56: 8.2 ↑</p> <p>57: 9.5 ↗</p> <p>58: 9.3 ←</p> <p>59: 10.4x ↖</p> <p>60: 6.2 ←</p> <hr/> <p>Series 87 (1x)</p> <p style="text-align: center;">516 (7x)</p>

<p>60 Shots</p> <p style="text-align: center;">6 7 8 8 7 6</p>	<p>1: 10.3 ←</p> <p>2: 8.9 ↘</p> <p>3: 7.6 ←</p> <p>4: 10.2 ←</p> <p>5: 9.6 ↘</p> <p>6: 9.8 →</p> <p>7: 9.4 ←</p> <p>8: 8.5 ↗</p> <p>9: 8.2 ↘</p> <p>10: 7.0 →</p> <hr/> <p>Series 85 (0x)</p> <p style="text-align: center;">85 (0x)</p>	<p>60 Shots</p> <p style="text-align: center;">7 8 8 7</p>	<p>11: 10.0 ↖</p> <p>12: 10.2 ↘</p> <p>13: 8.9 ↑</p> <p>14: 9.2 ←</p> <p>15: 8.9 ↘</p> <p>16: 9.5 ←</p> <p>17: 9.1 ↘</p> <p>18: 7.0 ↗</p> <p>19: 7.5 ↓</p> <p>20: 8.3 ↖</p> <hr/> <p>Series 85 (0x)</p> <p style="text-align: center;">170 (0x)</p>
--	---	--	---

<p>60 Shots</p> <p style="text-align: center;">5 6 7 6 7 6 5</p>	<p>21: 8.4 →</p> <p>22: 7.6 ↘</p> <p>23: 8.7 ↗</p> <p>24: 8.9 ←</p> <p>25: 9.2 →</p> <p>26: 8.5 ↓</p> <p>27: 6.4 →</p> <p>28: 10.4x ↗</p> <p>29: 7.7 →</p> <p>30: 9.0 ↑</p> <hr/> <p>Series 80 (1x)</p> <p style="text-align: center;">250 (1x)</p>	<p>60 Shots</p> <p style="text-align: center;">6 7 8 7 6</p>	<p>31: 8.4 ←</p> <p>32: 9.3 ↑</p> <p>33: 8.9 →</p> <p>34: 9.2 ↖</p> <p>35: 6.2 ↑</p> <p>36: 8.8 ↓</p> <p>37: 8.0 ↗</p> <p>38: 8.8 ↓</p> <p>39: 9.5 ←</p> <p>40: 8.5 ←</p> <hr/> <p>Series 81 (0x)</p> <p style="text-align: center;">331 (1x)</p>
--	---	--	---

<p>60 Shots</p> <p style="text-align: center;">5 6 7 8 6 7 6 5</p>	<p>41: 10.1 →</p> <p>42: 6.0 ←</p> <p>43: 9.8 ↘</p> <p>44: 7.8 ↗</p> <p>45: 8.6 →</p> <p>46: 8.7 ←</p> <p>47: 10.0 →</p> <p>48: 9.2 ←</p> <p>49: 8.2 →</p> <p>50: 10.1 ←</p> <hr/> <p>Series 85 (0x)</p> <p style="text-align: center;">416 (1x)</p>	<p>60 Shots</p> <p style="text-align: center;">1 2 3 4 5 7 8 8 7 6 5 4 3 2 8 7 6 5 4 3 2 1</p>	<p>51: 10.4x ↑</p> <p>52: 8.0 ↘</p> <p>53: 9.4 ←</p> <p>54: 7.6 ↘</p> <p>55: 2.5 ←</p> <p>56: 7.5 ↑</p> <p>57: 6.5 ↑</p> <p>58: 8.5 ↗</p> <p>59: 6.9 ↘</p> <p>60: 8.0 →</p> <hr/> <p>Series 71 (1x)</p> <p style="text-align: center;">487 (2x)</p>
--	--	--	---

<p>60 Shots</p>	<p>1: 9.4 ↑ 2: 8.6 → 3: 9.5 ↖ 4: 9.1 ← 5: 8.9 ← 6: 9.5 → 7: 8.0 ← 8: 10.3 → 9: 9.8 ↗ 10: 10.1 ↑</p> <p>Series 89 (0x) 89 (0x)</p>	<p>60 Shots</p>	<p>11: 8.4 ← 12: 9.4 ← 13: 10.5x ↑ 14: 7.2 ↖ 15: 9.4 ↖ 16: 8.8 ↘ 17: 10.4x ← 18: 8.7 → 19: 9.6 ↘ 20: 8.6 ↗</p> <p>Series 86 (2x) 175 (2x)</p>
-----------------	---	-----------------	---

<p>60 Shots</p>	<p>21: 9.9 ↑ 22: 10.2 → 23: 9.0 ← 24: 9.9 ← 25: 10.0 ↑ 26: 10.5x ↓ 27: 9.0 ↗ 28: 10.4x ↗ 29: 9.1 ↖ 30: 9.7 ↑</p> <p>Series 94 (2x) 269 (4x)</p>	<p>60 Shots</p>	<p>31: 10.0 ↖ 32: 10.0 ← 33: 9.6 ← 34: 9.6 ↗ 35: 9.9 ↗ 36: 9.3 ← 37: 10.0 ↓ 38: 8.7 ↑ 39: 10.4x ← 40: 7.9 ↖</p> <p>Series 91 (1x) 360 (5x)</p>
-----------------	---	-----------------	--

<p>60 Shots</p>	<p>41: 10.2 ↑ 42: 9.8 ↖ 43: 9.3 ↖ 44: 9.4 ↖ 45: 9.3 ↑ 46: 8.7 ← 47: 10.1 ↓ 48: 10.0 ← 49: 9.8 ↘ 50: 10.1 ↖</p> <p>Series 93 (0x) 453 (5x)</p>	<p>60 Shots</p>	<p>51: 9.6 ← 52: 7.8 ↗ 53: 9.0 ↖ 54: 9.7 ↖ 55: 10.5x ← 56: 9.5 ↓ 57: 10.7x ← 58: 10.2 ↗ 59: 9.2 → 60: 10.1 ↓</p> <p>Series 92 (2x) 545 (7x)</p>
-----------------	---	-----------------	---

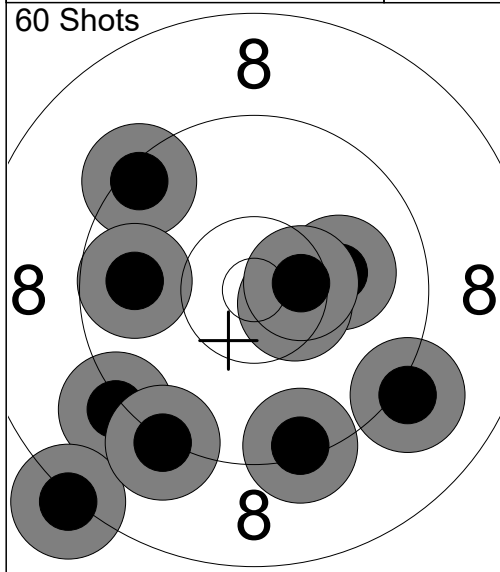

1:	9.4	↗
2:	9.2	↙
3:	8.2	↙
4:	9.3	↘
5:	10.1	→
6:	9.1	↘
7:	10.5x	→
8:	10.5x	→
9:	9.8	←
10:	9.2	↘
Series	92 (2x)	
	92 (2x)	

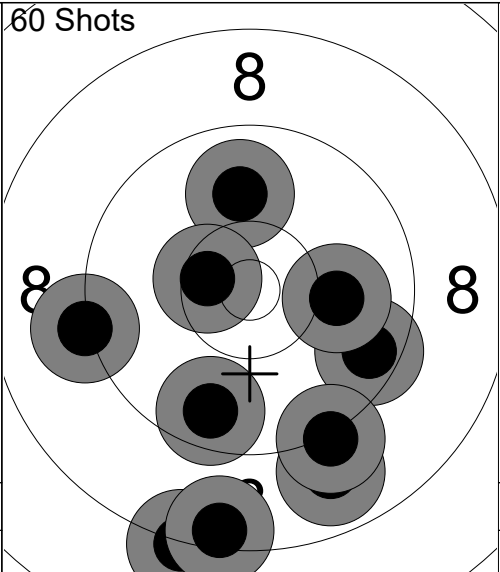

11:	8.9	↘
12:	9.9	↑
13:	8.2	↘
14:	9.6	↘
15:	10.5x	←
16:	8.4	↘
17:	9.6	↘
18:	10.0	→
19:	9.2	↘
20:	9.2	←
Series	89 (1x)	
	181 (3x)	

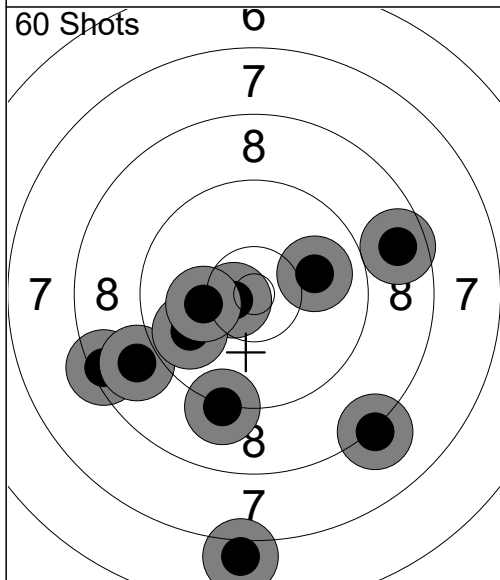

21:	8.4	←
22:	9.2	↘
23:	8.2	↘
24:	8.9	←
25:	7.0	↘
26:	10.6x	←
27:	9.8	←
28:	10.2	←
29:	10.0	→
30:	8.7	→
Series	87 (1x)	
	268 (4x)	

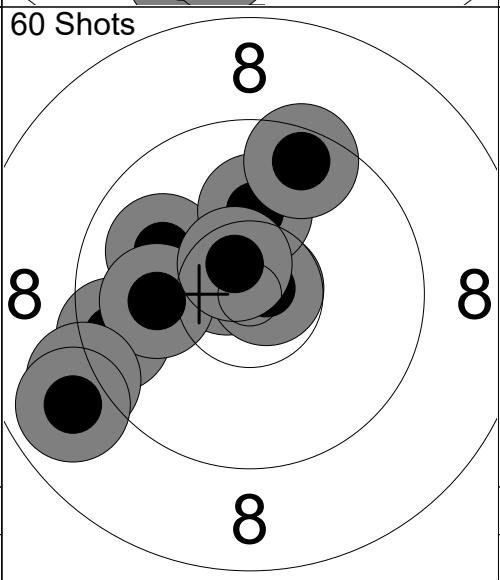

31:	10.0	↖
32:	9.6	←
33:	10.7x	↖
34:	10.8x	→
35:	10.0	←
36:	10.1	↑
37:	9.5	↑
38:	9.1	←
39:	10.6x	↗
40:	8.9	←
Series	95 (3x)	
	363 (7x)	

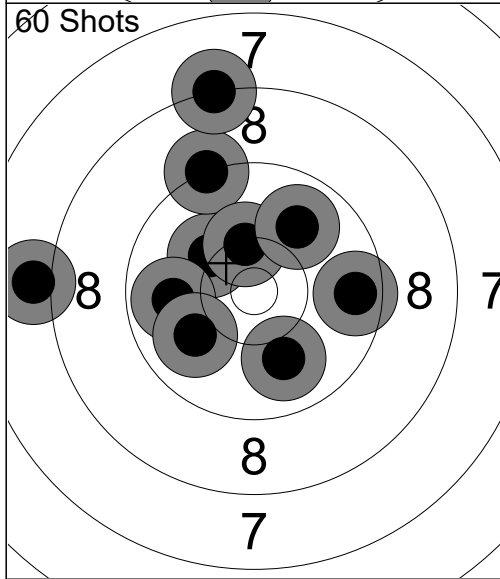

41:	10.2	↖
42:	9.2	↑
43:	10.0	↘
44:	8.0	←
45:	8.2	↑
46:	10.3	↑
47:	9.9	←
48:	10.0	←
49:	9.6	→
50:	9.9	↗
Series	92 (0x)	
	455 (7x)	

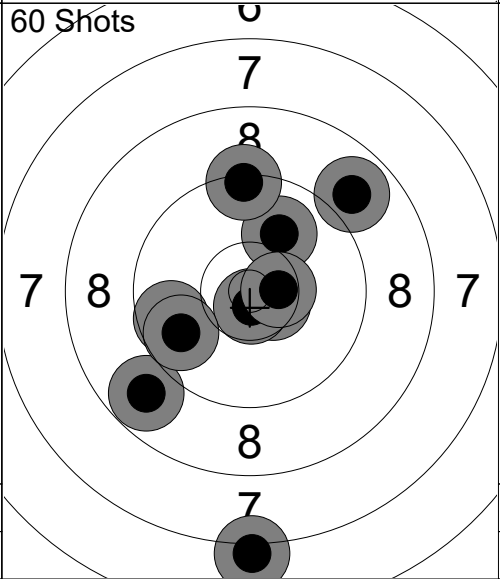

51:	10.0	↗
52:	10.6x	→
53:	8.8	↙
54:	9.3	↑
55:	9.7	←
56:	10.7x	↘
57:	7.1	↘
58:	8.9	↗
59:	9.8	←
60:	10.5x	→
Series	90 (3x)	
	545 (10x)	

Relay 5	Lane 67	ARKIN Elie	
1-80	NoVA Frame Hitters	Pistol	
31.01.2025	2025 AirNats by X Count	Civilian Marksmanship Program	
Comment	Signature		

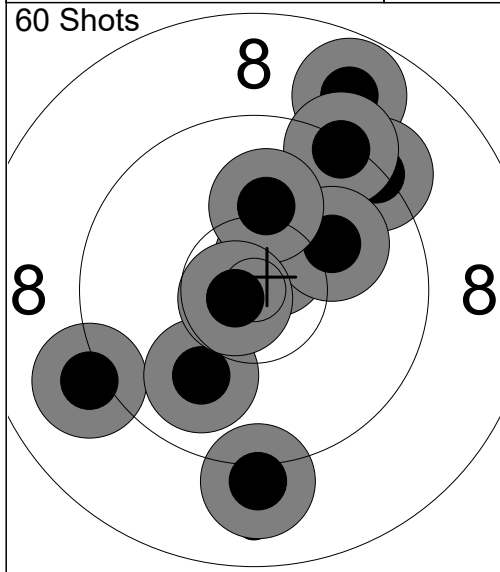

1:	10.6x ↗
2:	8.8 ↗
3:	9.3 ↗
4:	9.3 ↗
5:	10.1 ↗
6:	10.1 ↑
7:	9.1 ←
8:	10.0 ↓
9:	9.1 ↓
10:	10.8x ←
Series	94 (2x)
	94 (2x)

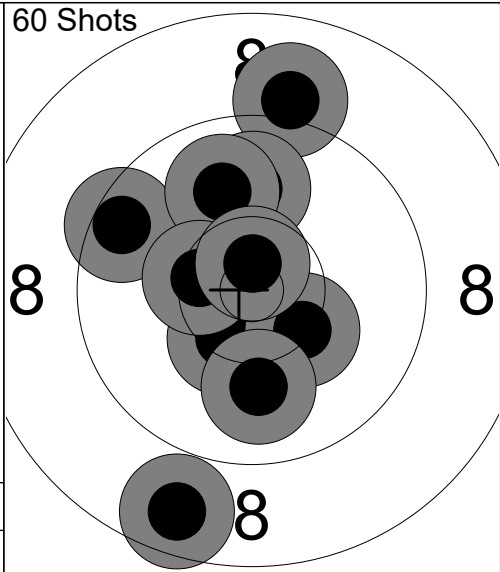

11:	10.4x ↓
12:	10.3 ↘
13:	9.5 ↖
14:	9.0 ↑
15:	10.0 ↑
16:	9.9 ↑
17:	8.7 ↓
18:	10.4x ←
19:	10.0 ↓
20:	10.7x ↑
Series	95 (3x)
	189 (5x)

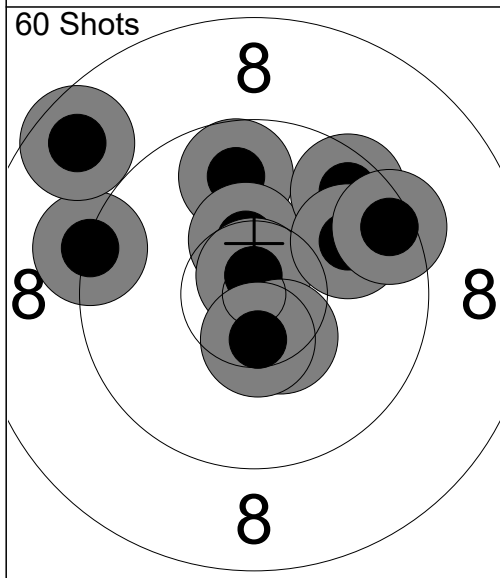

21:	9.3 ←
22:	9.8 ↑
23:	10.4x ↑
24:	10.8x ↑
25:	9.6 ↗
26:	9.9 ↗
27:	8.7 ↖
28:	10.5x ↓
29:	10.5x ↓
30:	9.5 ↗
Series	93 (4x)
	282 (9x)

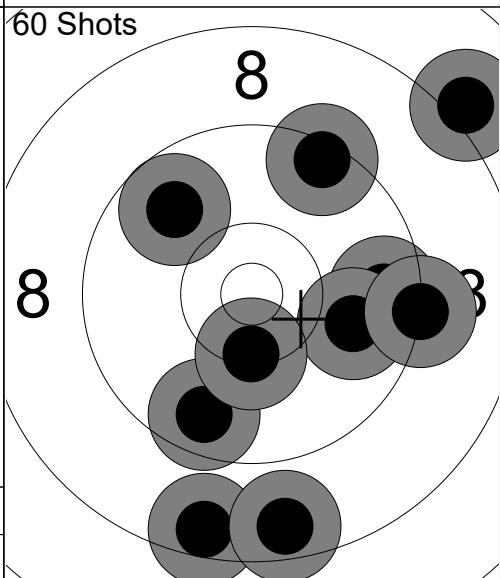

31:	9.6 →
32:	9.9 →
33:	9.4 ↗
34:	9.6 ↓
35:	9.8 ↗
36:	8.0 ↗
37:	10.3 ↓
38:	8.5 ↓
39:	9.2 →
40:	8.6 ↓
Series	88 (0x)
	370 (9x)

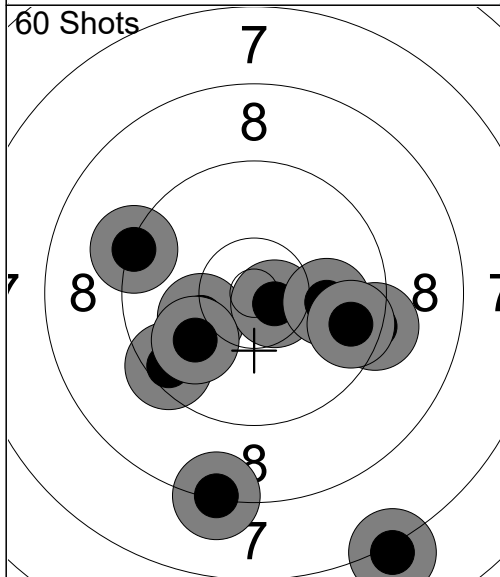

41:	9.5 ↓
42:	9.3 →
43:	9.3 ↖
44:	10.2 ←
45:	10.7x ↘
46:	10.0 →
47:	7.1 ↓
48:	10.0 ←
49:	9.6 →
50:	8.3 ↓
Series	91 (1x)
	461 (10x)

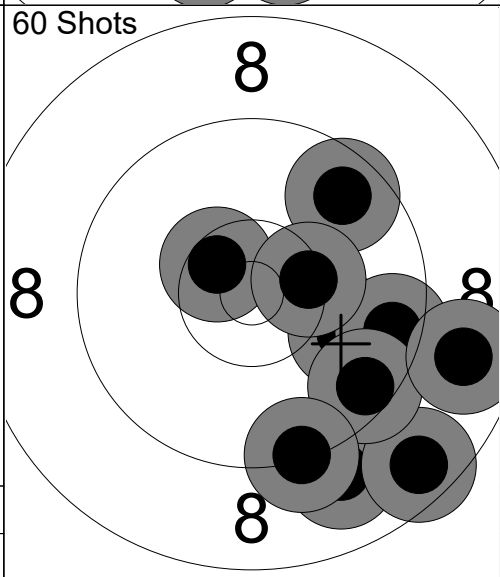

51:	9.6 ↗
52:	10.0 →
53:	9.0 ↓
54:	10.5x ↗
55:	9.5 →
56:	8.6 ↓
57:	9.5 ↓
58:	8.8 →
59:	9.3 ↓
60:	10.4x →
Series	91 (2x)
	552 (12x)

Relay 5	Lane 68	REGALA Will	
1-80	NoVA Frame Hitters	Pistol	
31.01.2025	2025 AirNats by X Count	Civilian Marksmanship Program	
Comment	Signature		

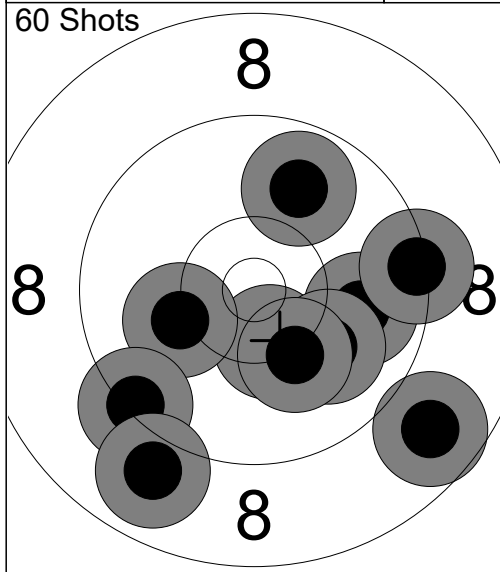

1:	9.9	→
2:	10.4x	↓
3:	10.0	↘
4:	9.9	↑
5:	10.2	↓
6:	9.3	→
7:	10.2	←
8:	9.3	↙
9:	8.7	↘
10:	8.9	↓
Series	92	(1x)
	92	(1x)

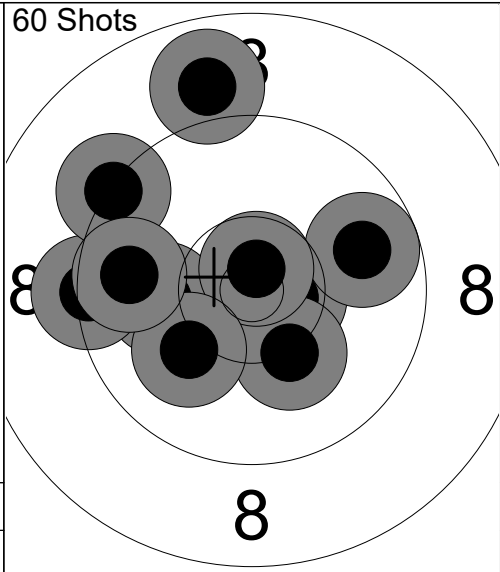

11:	10.1	←
12:	10.6x	→
13:	9.3	←
14:	9.8	→
15:	10.2	↓
16:	10.7x	↑
17:	10.1	↙
18:	9.3	↖
19:	9.7	←
20:	8.9	↑
Series	94	(2x)
	186	(3x)

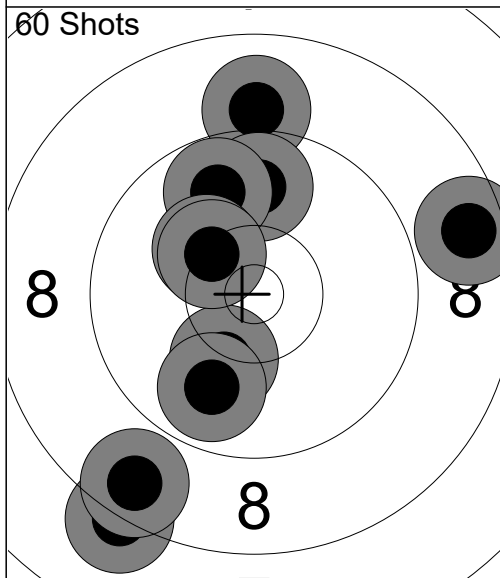

21:	9.0	↑
22:	9.8	↑
23:	9.8	↑
24:	10.3	↗
25:	10.2	↓
26:	8.2	↓
27:	8.6	↓
28:	9.9	↓
29:	10.3	↗
30:	8.6	→
Series	90	(0x)
	276	(3x)

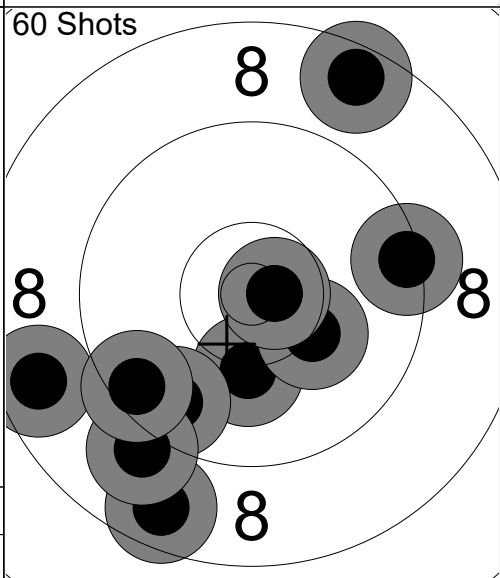

31:	8.6	←
32:	10.2	↓
33:	9.6	↙
34:	8.6	↓
35:	8.5	↑
36:	9.1	↙
37:	10.2	↘
38:	9.4	→
39:	9.5	↙
40:	10.7x	→
Series	90	(1x)
	366	(4x)

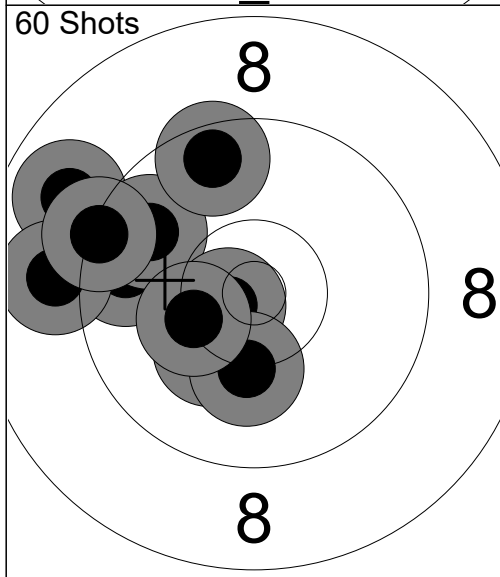

41:	8.9	↖
42:	9.7	←
43:	9.8	↗
44:	9.0	←
45:	10.3	↓
46:	9.3	↖
47:	10.7x	←
48:	9.6	↑
49:	10.2	↓
50:	10.3	←
Series	93	(1x)
	459	(5x)

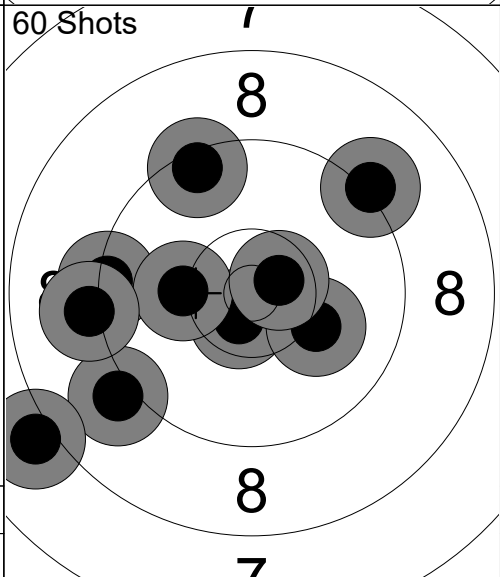

51:	9.4	↗
52:	10.6x	↓
53:	9.1	↙
54:	9.3	←
55:	8.0	↙
56:	10.1	↘
57:	10.2	←
58:	10.6x	→
59:	9.1	←
60:	9.2	↗
Series	93	(2x)
	552	(7x)

<p>60 Shots</p>	<p>1: 8.5 ↗ 2: 5.5 ← 3: 9.3 → 4: 9.8 ↗ 5: 7.5 ↘ 6: 9.2 ↙ 7: 9.3 ↓ 8: 9.6 ↑ 9: 7.9 ↓ 10: 8.6 ↘</p> <p>Series 80 (0x) 80 (0x)</p>	<p>60 Shots</p>	<p>11: 8.3 ↓ 12: 8.1 ↘ 13: 8.2 ↓ 14: 10.3 ↘ 15: 9.8 ↓ 16: 5.5 ↓ 17: 8.6 → 18: 9.5 → 19: 9.7 ← 20: 10.3 ↓</p> <p>Series 84 (0x) 164 (0x)</p>
-----------------	---	-----------------	---

<p>60 Shots</p>	<p>21: 9.8 ↘ 22: 10.7x ↗ 23: 10.4x ↗ 24: 7.4 ↓ 25: 5.4 ↓ 26: 8.4 → 27: 7.3 ↓ 28: 6.6 ↓ 29: 7.6 ← 30: 8.6 →</p> <p>Series 77 (2x) 241 (2x)</p>	<p>60 Shots</p>	<p>31: 7.8 ← 32: 10.7x ↙ 33: 7.9 → 34: 9.7 ← 35: 9.0 ↗ 36: 9.5 ↓ 37: 10.3 ↓ 38: 8.9 ↙ 39: 8.3 ↗ 40: 9.4 ↗</p> <p>Series 86 (1x) 327 (3x)</p>
-----------------	---	-----------------	--

<p>60 Shots</p>	<p>41: 9.1 ← 42: 8.6 ↑ 43: 8.3 ↗ 44: 6.6 ↘ 45: 9.9 → 46: 5.5 ↗ 47: 8.0 ↓ 48: 9.9 ↑ 49: 9.2 ↑ 50: 9.1 →</p> <p>Series 80 (0x) 407 (3x)</p>	<p>60 Shots</p>	<p>51: 6.3 ↙ 52: 8.3 ↗ 53: 7.0 ← 54: 9.4 ↗ 55: 7.9 ↗ 56: 9.5 ← 57: 9.6 ↑ 58: 10.0 ↑ 59: 9.4 ↘ 60: 9.8 →</p> <p>Series 83 (0x) 490 (3x)</p>
-----------------	---	-----------------	--

Relay 5	Lane 70	WANG Nina
-------------------	-------------------	------------------

1-80	NoVA Target Masters	Pistol
------	---------------------	--------

31.01.2025	2025 AirNats by X Count	Civilian Marksmanship Program
------------	-------------------------	-------------------------------

Comment	Signature
---------	-----------

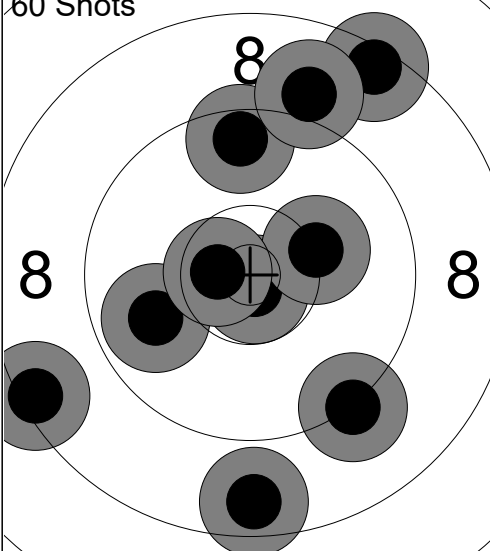
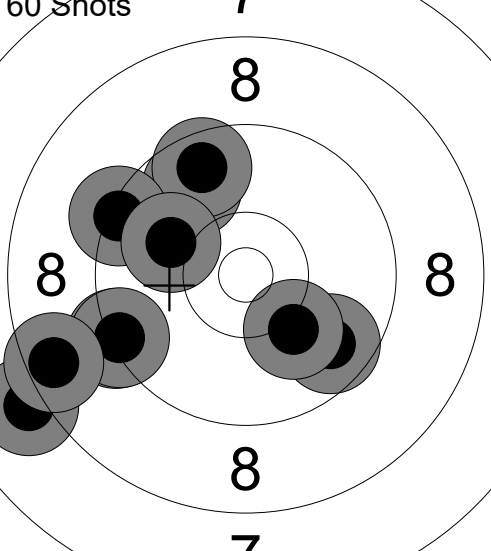
<p>60 Shots</p> 	<p>1: 8.4 ← 2: 9.5 ↑ 3: 8.6 ↓ 4: 9.2 ↓ 5: 8.4 ↑ 6: 9.9 ← 7: 10.8x ↓ 8: 10.2 → 9: 9.0 ↑ 10: 10.6x ←</p> <p>Series 90 (2x) 90 (2x)</p>	<p>60 Shots</p> 	<p>11: 9.7 ↘ 12: 9.8 ↗ 13: 9.6 ↗ 14: 9.4 ↖ 15: 9.3 ← 16: 10.1 ↓ 17: 9.3 ← 18: 8.1 ← 19: 10.0 ↖ 20: 8.5 ←</p> <p>Series 90 (0x) 180 (2x)</p>
--	--	--	---

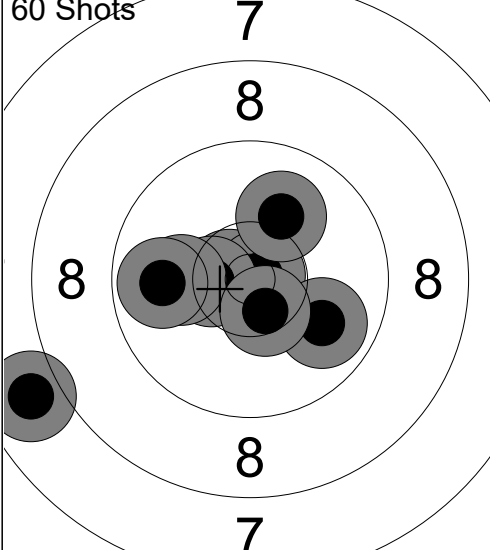
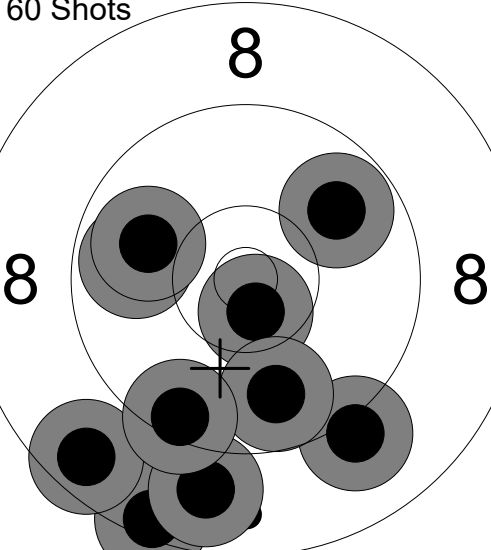
<p>60 Shots</p> 	<p>21: 10.9x ↓ 22: 10.7x ← 23: 10.8x → 24: 10.5x ← 25: 9.9 → 26: 10.1 ↑ 27: 7.9 ← 28: 10.1 ← 29: 9.9 ← 30: 10.5x ↓</p> <p>Series 95 (5x) 275 (7x)</p>	<p>60 Shots</p> 	<p>31: 9.9 ← 32: 8.4 ↓ 33: 9.1 ↓ 34: 10.6x ↓ 35: 8.6 ↓ 36: 9.8 ↗ 37: 8.8 ↓ 38: 9.8 ↓ 39: 9.9 ↖ 40: 9.4 ↓</p> <p>Series 88 (1x) 363 (8x)</p>
---	---	---	---

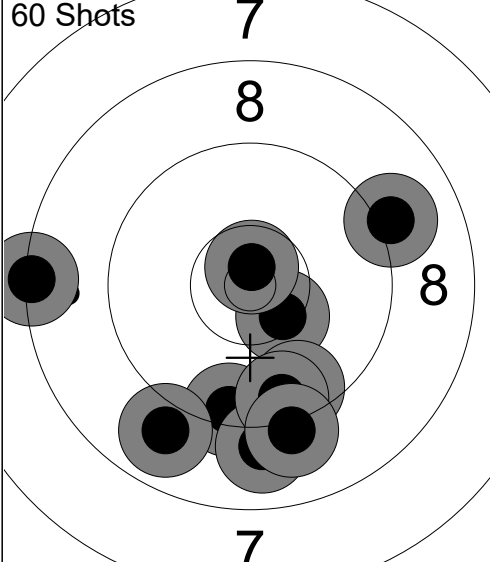
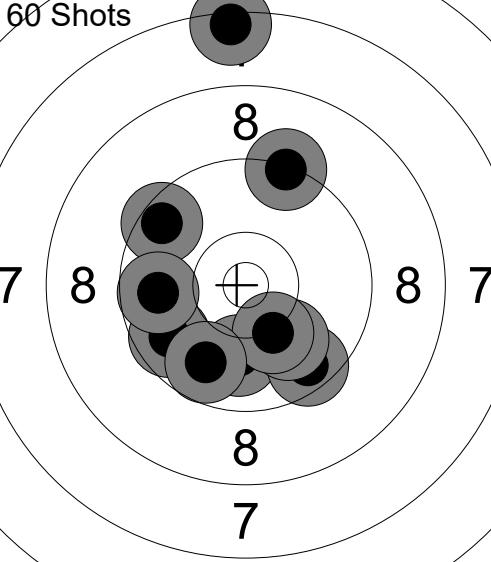
<p>60 Shots</p> 	<p>41: 9.4 ↓ 42: 9.1 → 43: 10.4x ↓ 44: 10.7x ↑ 45: 9.6 ↓ 46: 9.0 ↓ 47: 9.5 ↓ 48: 8.3 ← 49: 9.1 ↓ 50: 8.9 ↓</p> <p>Series 90 (2x) 453 (10x)</p>	<p>60 Shots</p> 	<p>51: 9.7 ← 52: 10.0 ↓ 53: 9.6 ↓ 54: 10.0 ↓ 55: 10.2 ↓ 56: 9.5 ↗ 57: 9.8 ↓ 58: 9.7 ← 59: 7.4 ↑ 60: 9.3 ↑</p> <p>Series 91 (0x) 544 (10x)</p>
--	--	--	---

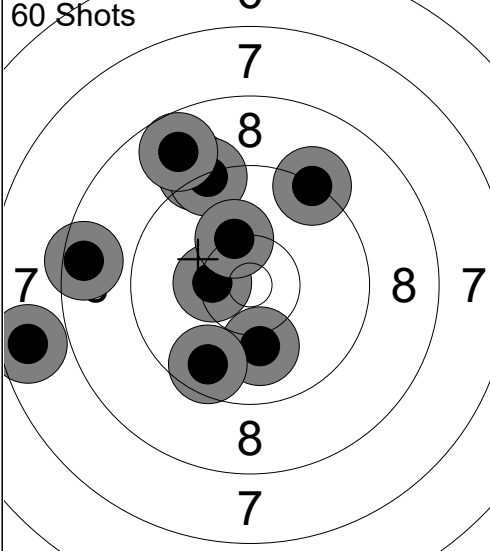
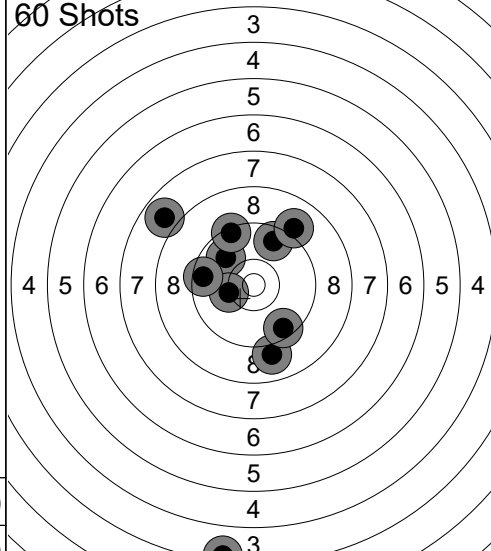
<p>60 Shots</p> 	<p>1: 8.5 ←</p> <p>2: 10.4x ←</p> <p>3: 7.6 ←</p> <p>4: 9.1 ↗</p> <p>5: 9.3 ↗</p> <p>6: 8.8 ↗</p> <p>7: 9.3 ↗</p> <p>8: 10.2 ↗</p> <p>9: 10.1 ↓</p> <p>10: 9.7 ↓</p> <hr/> <p>Series 89 (1x)</p> <p>89 (1x)</p>	<p>60 Shots</p> 	<p>11: 9.9 ↗</p> <p>12: 9.4 ↗</p> <p>13: 10.2 ←</p> <p>14: 9.6 ↗</p> <p>15: 9.0 ↓</p> <p>16: 9.5 ←</p> <p>17: 9.0 ↗</p> <p>18: 9.5 ↓</p> <p>19: 3.4 ↓</p> <p>20: 7.9 ↖</p> <hr/> <p>Series 83 (0x)</p> <p>172 (1x)</p>
--	---	--	--

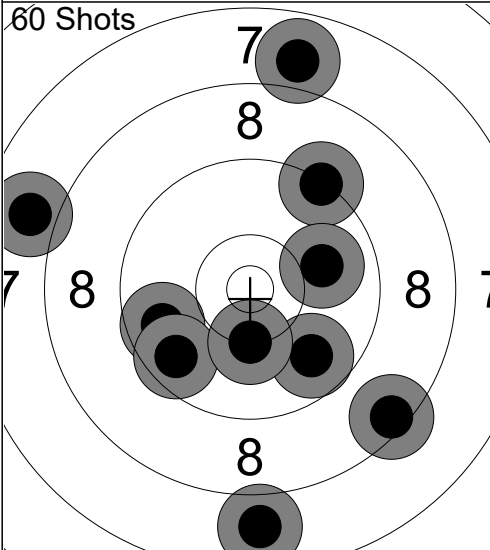
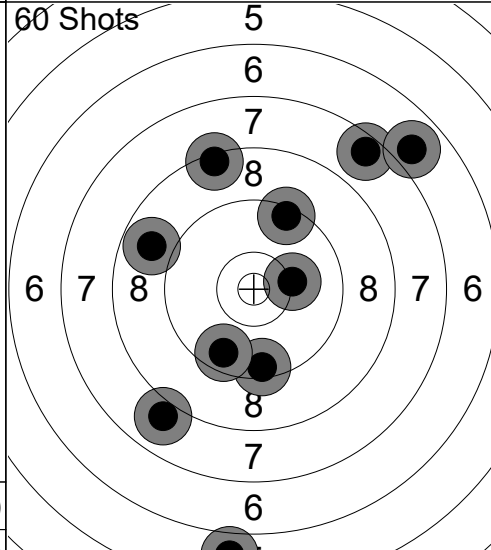
<p>60 Shots</p> 	<p>21: 9.3 ↗</p> <p>22: 9.7 ←</p> <p>23: 8.4 ↓</p> <p>24: 9.8 ↓</p> <p>25: 7.9 ←</p> <p>26: 7.9 ↗</p> <p>27: 9.6 ↖</p> <p>28: 7.8 ↓</p> <p>29: 9.9 →</p> <p>30: 10.3 ↓</p> <hr/> <p>Series 84 (0x)</p> <p>256 (1x)</p>	<p>60 Shots</p> 	<p>31: 8.8 ←</p> <p>32: 9.4 ↓</p> <p>33: 9.6 ↓</p> <p>34: 7.5 ↗</p> <p>35: 10.2 →</p> <p>36: 5.8 ↓</p> <p>37: 8.4 ↗</p> <p>38: 9.4 ↗</p> <p>39: 6.9 ↗</p> <p>40: 7.9 ↓</p> <hr/> <p>Series 78 (0x)</p> <p>334 (1x)</p>
---	--	---	--

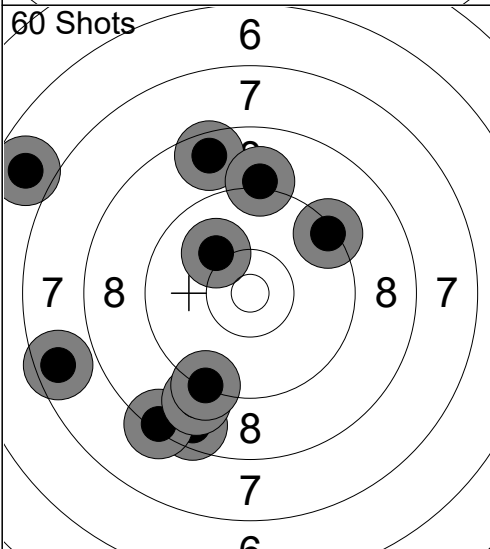
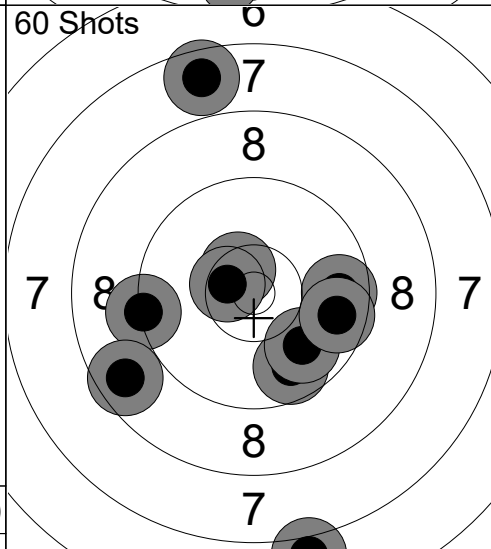
<p>60 Shots</p> 	<p>41: 8.6 ↗</p> <p>42: 8.6 ↓</p> <p>43: 10.1 ↗</p> <p>44: 6.8 ↖</p> <p>45: 9.1 ↗</p> <p>46: 9.4 ↗</p> <p>47: 8.3 ↓</p> <p>48: 9.0 ↓</p> <p>49: 7.6 ←</p> <p>50: 9.3 ↓</p> <hr/> <p>Series 83 (0x)</p> <p>417 (1x)</p>	<p>60 Shots</p> 	<p>51: 9.7 ↓</p> <p>52: 10.5x ↗</p> <p>53: 9.3 ←</p> <p>54: 9.9 ↓</p> <p>55: 9.7 →</p> <p>56: 7.0 ↓</p> <p>57: 7.6 ↗</p> <p>58: 9.7 →</p> <p>59: 8.7 ←</p> <p>60: 10.5x ←</p> <hr/> <p>Series 87 (2x)</p> <p>504 (3x)</p>
--	--	--	---

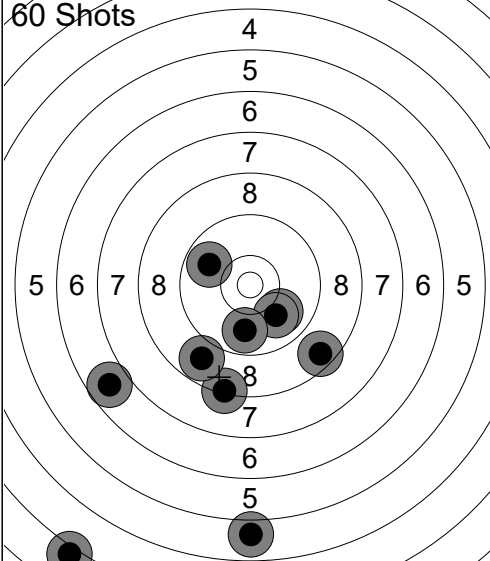
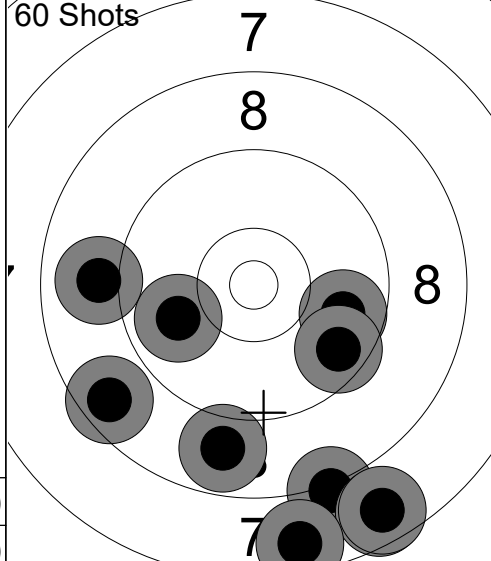
<p>60 Shots</p> 	<p>1: 3.1 ↙ 2: 10.0 ↘ 3: 10.0 ↘ 4: 8.3 ↓ 5: 8.8 ↙ 6: 9.8 ↗ 7: 6.8 ← 8: 9.8 ↓ 9: 8.6 ↘ 10: 4.9 ↓</p> <p>Series 75 (0x) 75 (0x)</p>	<p>60 Shots</p>  <p>11: 8.2 ↘ 12: 8.8 ↘ 13: 7.6 ↘ 14: 9.9 ← 15: 8.6 ↙ 16: 7.6 ↘ 17: 7.6 ↓ 18: 9.0 ← 19: 9.8 → 20: 9.6 ↘</p> <p>Series 81 (0x) 156 (0x)</p>
--	---	--

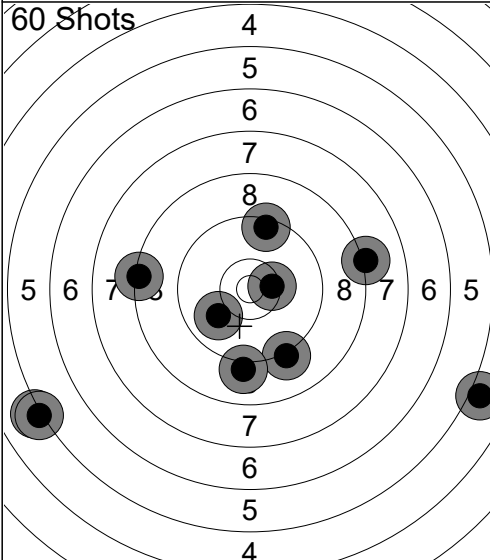
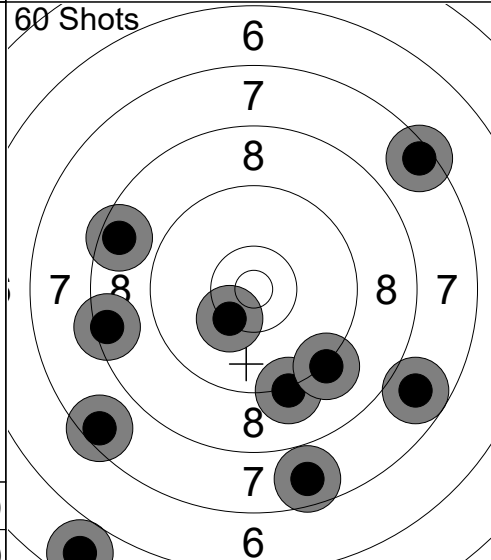
<p>60 Shots</p> 	<p>21: 9.2 ↘ 22: 5.0 → 23: 8.1 → 24: 5.1 ← 25: 9.1 ↓ 26: 10.4x → 27: 5.2 ← 28: 10.0 ← 29: 8.3 ← 30: 9.4 ↑</p> <p>Series 78 (1x) 234 (1x)</p>	<p>60 Shots</p>  <p>31: 7.4 ↗ 32: 5.7 ↘ 33: 9.2 ↓ 34: 10.3 ↘ 35: 8.5 ← 36: 7.5 ↙ 37: 7.7 ↓ 38: 8.4 ← 39: 7.8 ↘ 40: 9.2 ↘</p> <p>Series 77 (0x) 311 (1x)</p>
---	--	--

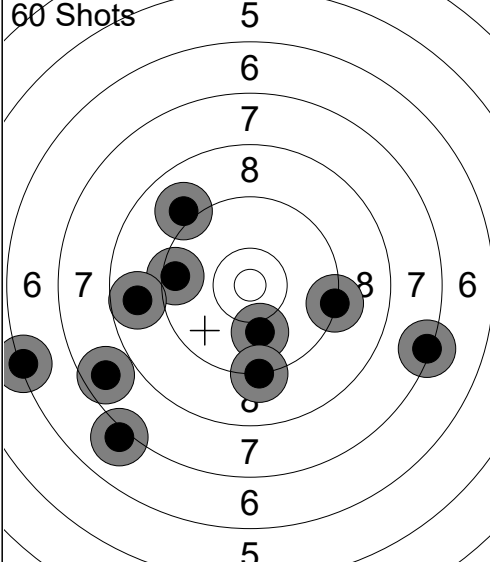
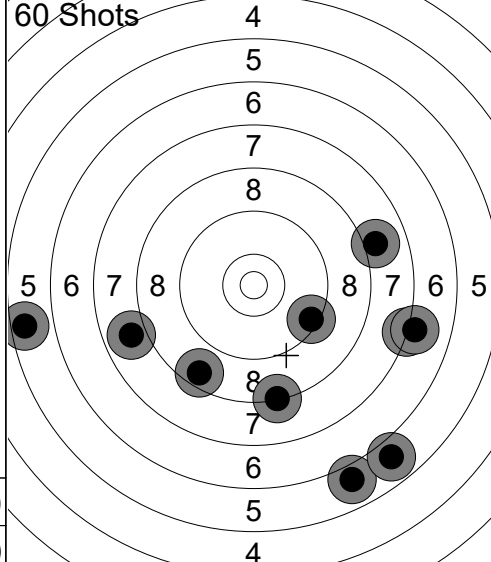
<p>60 Shots</p> 	<p>41: 10.0 ↓ 42: 9.2 ↓ 43: 9.5 ← 44: 6.3 ← 45: 8.8 ← 46: 9.0 ↗ 47: 7.7 ← 48: 7.3 → 49: 7.1 ↓ 50: 9.3 →</p> <p>Series 81 (0x) 392 (1x)</p>	<p>60 Shots</p>  <p>51: 5.5 ← 52: 7.9 ← 53: 7.2 → 54: 9.4 ↘ 55: 5.9 ↓ 56: 8.0 → 57: 8.3 ↓ 58: 5.9 ↓ 59: 8.5 ↓ 60: 7.1 →</p> <p>Series 69 (0x) 461 (1x)</p>
--	--	--

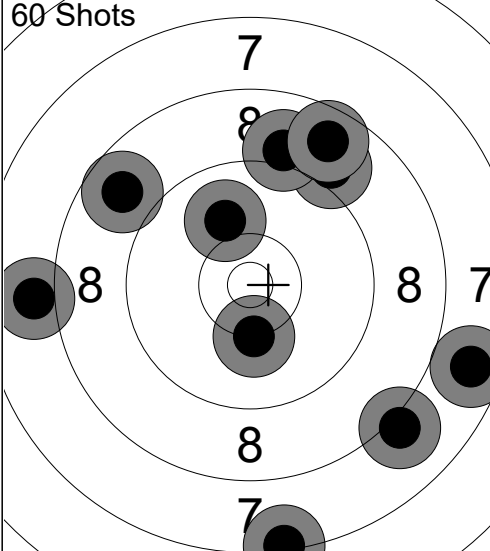
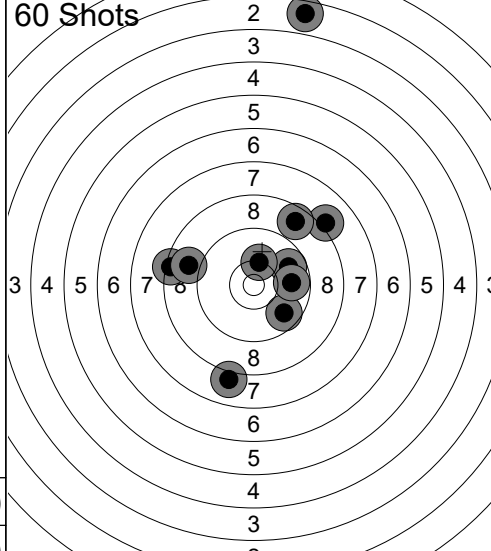
<p>60 Shots</p> 	<p>1: 10.2 ↓ 2: 9.0 ↗ 3: 7.9 ← 4: 9.0 ↑ 5: 10.0 ↑ 6: 8.7 ↗ 7: 8.1 ↘ 8: 8.8 ↗ 9: 7.7 → 10: 7.3 ↓</p> <p>Series 83 (0x) 83 (0x)</p>	<p>60 Shots</p>  <p>11: 8.4 ← 12: 8.1 ↗ 13: 9.7 ↘ 14: 9.8 ↗ 15: 8.7 ↗ 16: 9.8 → 17: 8.0 ↓ 18: 10.3 ↑ 19: 2.6 ↑ 20: 8.9 ←</p> <p>Series 79 (0x) 162 (0x)</p>
--	---	---

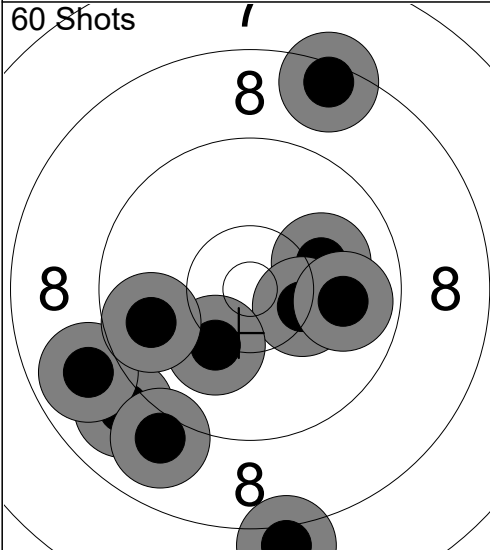
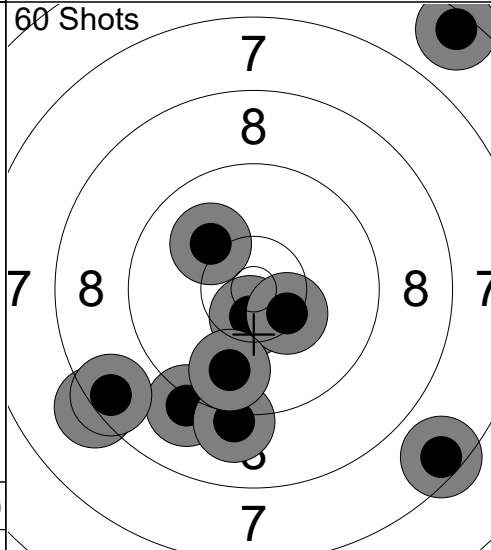
<p>60 Shots</p> 	<p>21: 10.1 → 22: 10.3 → 23: 8.4 ↑ 24: 9.0 ↓ 25: 8.9 ← 26: 9.9 → 27: 9.0 ↓ 28: 10.2 ↓ 29: 8.0 ↓ 30: 9.8 ←</p> <p>Series 90 (0x) 252 (0x)</p>	<p>60 Shots</p>  <p>31: 9.1 ↓ 32: 8.2 ← 33: 10.6x ↓ 34: 9.1 ↓ 35: 8.5 ← 36: 10.4x ↘ 37: 9.8 ↓ 38: 6.4 ↗ 39: 10.1 ↖ 40: 7.5 ↘</p> <p>Series 86 (2x) 338 (2x)</p>
---	--	--

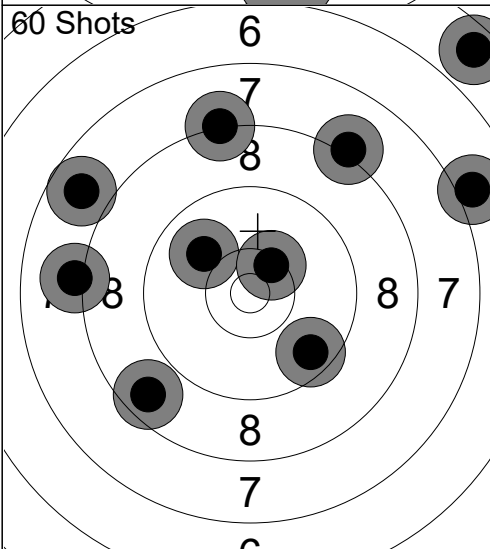
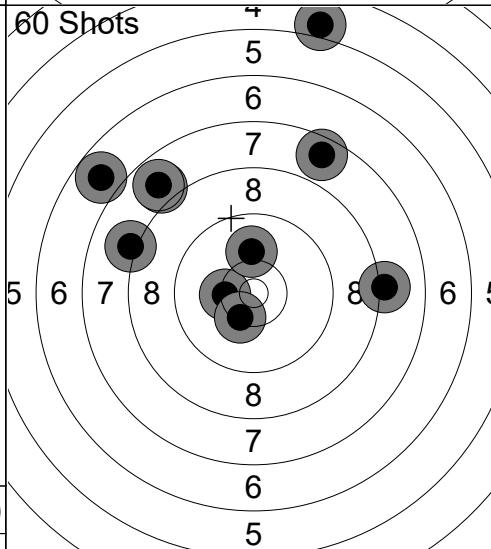
<p>60 Shots</p> 	<p>41: 8.1 ↗ 42: 9.6 ↘ 43: 10.0 ↖ 44: 8.6 ↓ 45: 7.0 → 46: 8.2 ↑ 47: 8.1 ← 48: 5.6 ↗ 49: 10.4x ↗ 50: 7.8 ←</p> <p>Series 80 (1x) 418 (3x)</p>	<p>60 Shots</p>  <p>51: 8.1 ← 52: 8.1 → 53: 6.8 ↖ 54: 7.6 ↑ 55: 5.0 ↑ 56: 10.3 ← 57: 7.9 ↖ 58: 7.8 ↖ 59: 10.4 ↓ 60: 10.1 ↑</p> <p>Series 78 (0x) 496 (3x)</p>
--	--	---

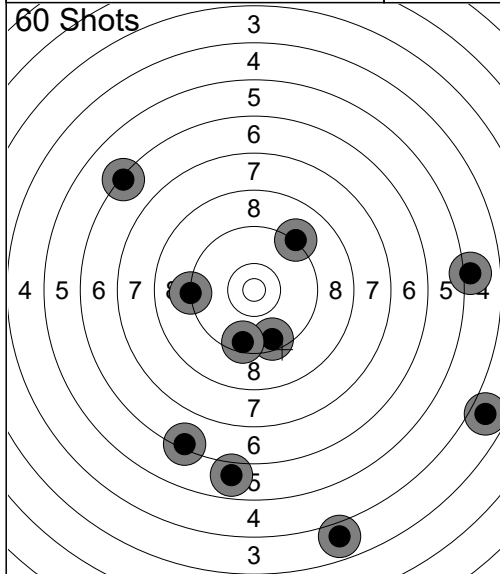

1:	6.3	↘
2:	9.5	↘
3:	5.1	→
4:	5.9	↘
5:	9.5	↘
6:	9.2	←
7:	9.2	↗
8:	3.8	↗
9:	6.3	↗
10:	3.9	↘
Series	64 (0x)	
	64 (0x)	

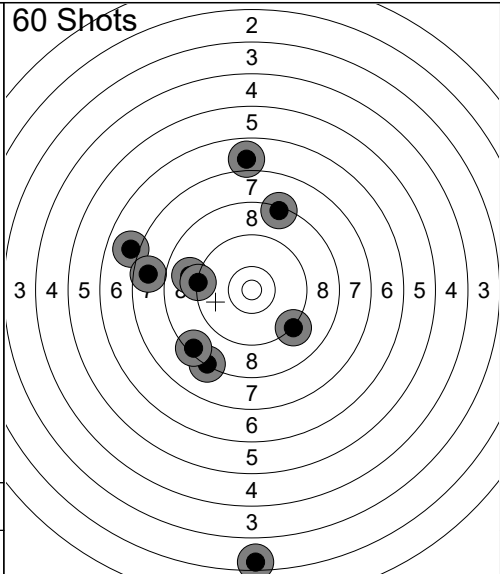

11:	9.0	←
12:	7.0	←
13:	8.3	↑
14:	8.3	↘
15:	8.4	↘
16:	2.5	↓
17:	6.9	↑
18:	7.7	←
19:	9.3	←
20:	9.2	↘
Series	73 (0x)	
	137 (0x)	

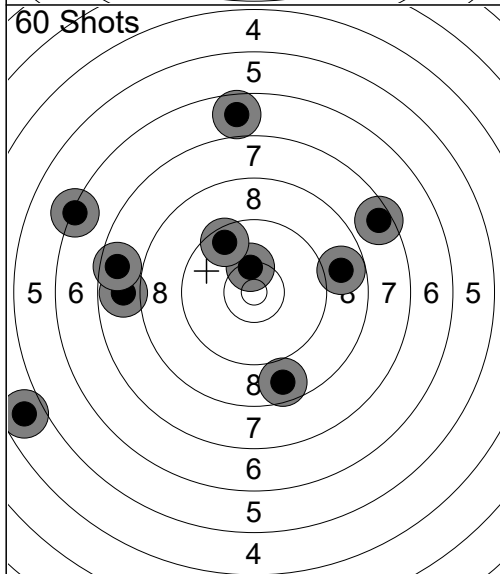

21:	7.8	←
22:	7.6	←
23:	8.8	→
24:	8.7	↘
25:	6.7	↑
26:	6.3	←
27:	10.4	↑
28:	9.6	↗
29:	7.5	↗
30:	4.8	←
Series	72 (0x)	
	209 (0x)	

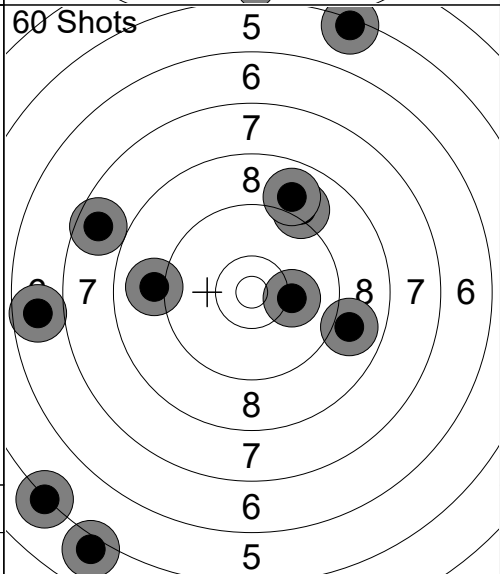

31:	5.2	↘
32:	6.7	←
33:	5.0	↘
34:	9.1	↗
35:	9.0	←
36:	10.1	→
37:	7.7	←
38:	8.9	↗
39:	5.4	↑
40:	8.9	↑
Series	72 (0x)	
	281 (0x)	

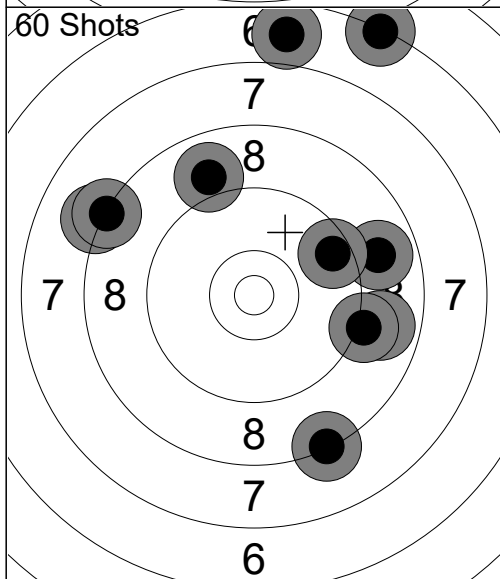

41:	6.3	↑
42:	8.9	→
43:	8.1	←
44:	8.9	↗
45:	8.2	↗
46:	8.9	→
47:	9.1	→
48:	8.3	↘
49:	6.8	↑
50:	9.5	↗
Series	78 (0x)	
	359 (0x)	

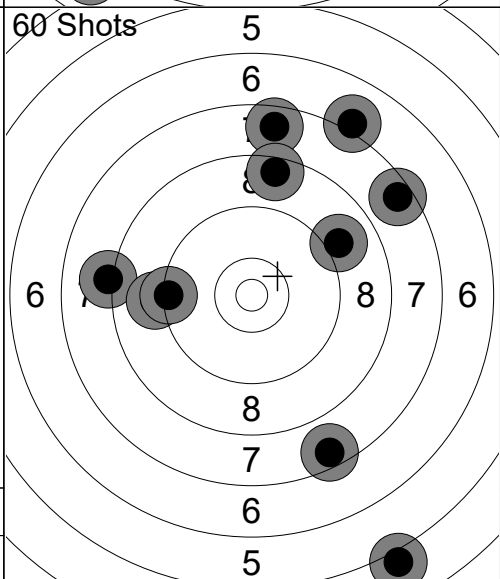

51:	7.6	↑
52:	5.0	↘
53:	8.1	←
54:	7.5	↗
55:	7.5	↘
56:	9.1	←
57:	8.5	↑
58:	9.3	←
59:	9.0	↗
60:	7.1	↗
Series	76 (0x)	
	435 (0x)	

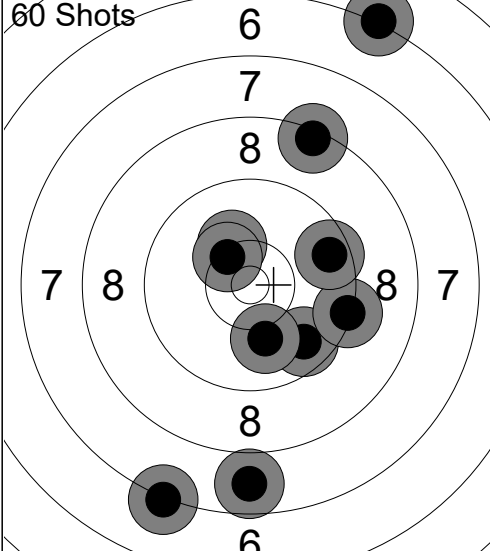
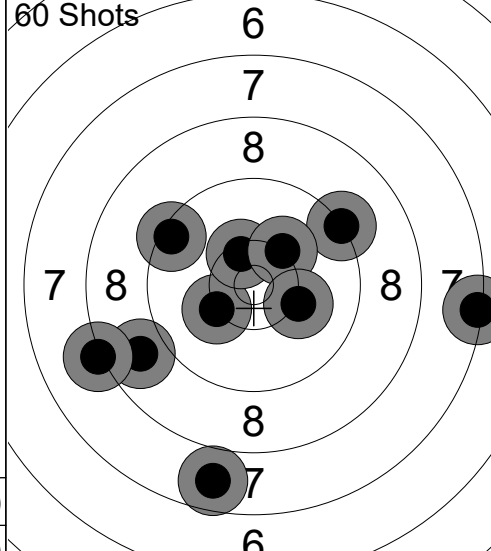
<p>60 Shots</p> 	<p>1: 8.4 ↗ 2: 10.2 ↗ 3: 9.7 ↘ 4: 6.2 ↗ 5: 9.3 ➡ 6: 10.4x ↗ 7: 9.6 ➡ 8: 7.2 ↘ 9: 10.1 ↘ 10: 7.7 ↘</p> <p>Series 85 (1x) 85 (1x)</p>	<p>60 Shots</p>  <p>11: 9.4 ↖ 12: 7.3 ➡ 13: 8.8 ↖ 14: 10.2 ↖ 15: 9.2 ↗ 16: 7.7 ↘ 17: 10.4x ↗ 18: 10.2 ↗ 19: 8.2 ↖ 20: 10.2 ➡</p> <p>Series 88 (1x) 173 (2x)</p>
--	---	---

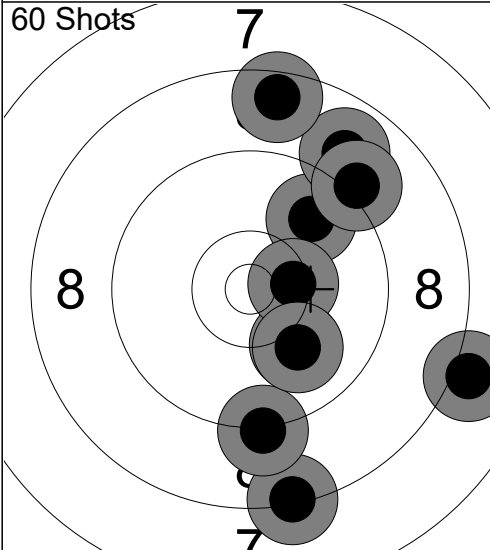
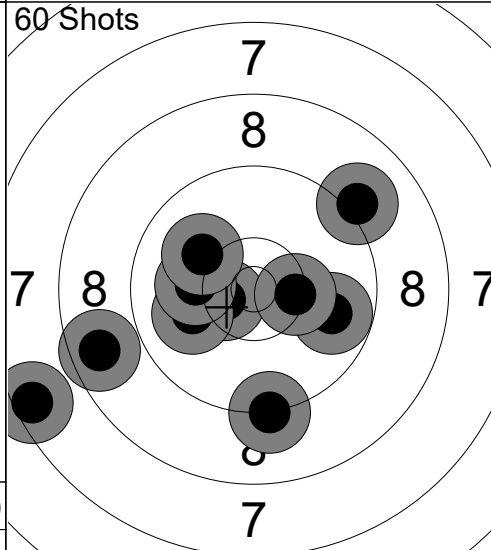
<p>60 Shots</p> 	<p>21: 9.8 ↗ 22: 10.1 ↘ 23: 8.0 ➡ 24: 10.4x ➡ 25: 8.9 ↗ 26: 8.5 ↗ 27: 8.3 ↘ 28: 9.2 ↘ 29: 9.1 ↗ 30: 10.0 ↘</p> <p>Series 89 (1x) 262 (3x)</p>	<p>60 Shots</p>  <p>31: 9.8 ➡ 32: 9.2 ↘ 33: 8.6 ↖ 34: 9.1 ↗ 35: 10.5x ↖ 36: 10.0 ↖ 37: 10.1 ↖ 38: 10.1 ↖ 39: 10.4x ➡ 40: 7.5 ↖</p> <p>Series 92 (2x) 354 (5x)</p>
---	---	--

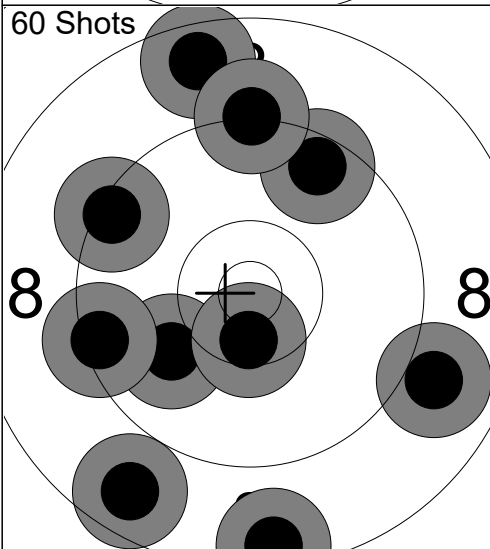
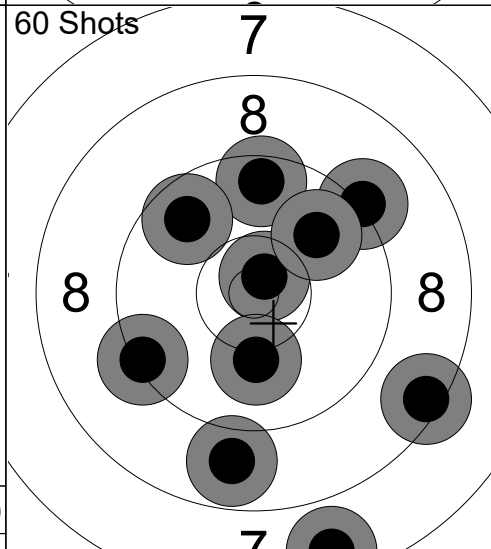
<p>60 Shots</p> 	<p>41: 10.0 ↖ 42: 8.7 ↘ 43: 9.4 ↖ 44: 8.6 ↗ 45: 10.5x ↘ 46: 9.5 ↗ 47: 9.2 ↗ 48: 8.9 ➡ 49: 9.4 ↖ 50: 8.4 ↘</p> <p>Series 88 (1x) 442 (6x)</p>	<p>60 Shots</p>  <p>51: 10.7x ↗ 52: 9.3 ↖ 53: 9.5 ↗ 54: 9.2 ↗ 55: 9.7 ↖ 56: 7.6 ↘ 57: 8.4 ➡ 58: 9.9 ↗ 59: 8.8 ↘ 60: 10.1 ↘</p> <p>Series 88 (1x) 530 (7x)</p>
--	--	---

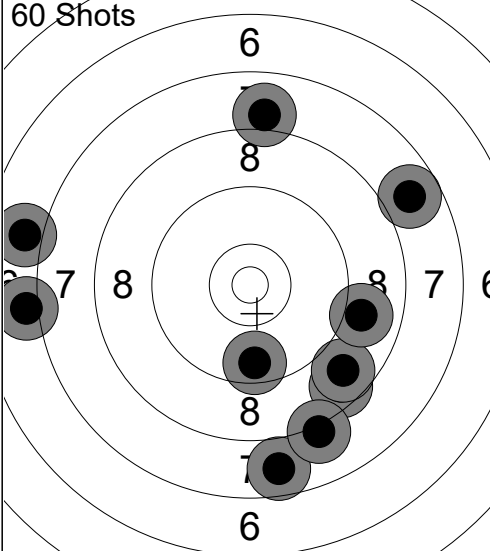
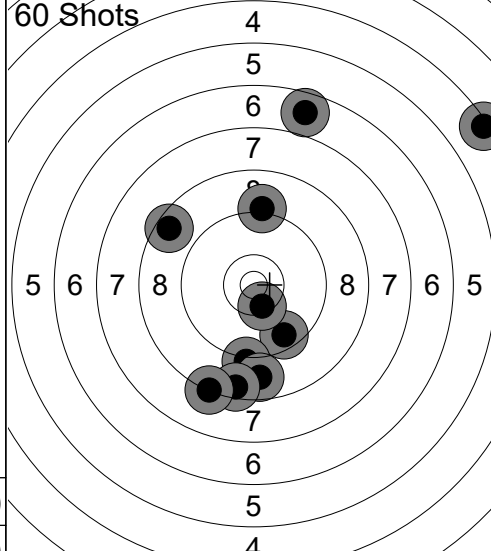
<p>60 Shots</p> 	<p>1: 7.0 ← 2: 9.6 ↓ 3: 7.7 ↓ 4: 7.8 → 5: 8.6 ↓ 6: 8.1 ↓ 7: 6.9 ← 8: 8.7 ↓ 9: 8.9 → 10: 8.0 ↑</p> <p>Series 76 (0x) 76 (0x)</p>	<p>60 Shots</p> 	<p>11: 9.6 ↓ 12: 10.4x ↓ 13: 4.4 → 14: 9.1 ↑ 15: 9.1 ↓ 16: 8.5 ↖ 17: 8.8 ↓ 18: 8.5 ↓ 19: 6.7 ↑ 20: 8.3 ↓</p> <p>Series 79 (1x) 155 (1x)</p>
--	---	--	---

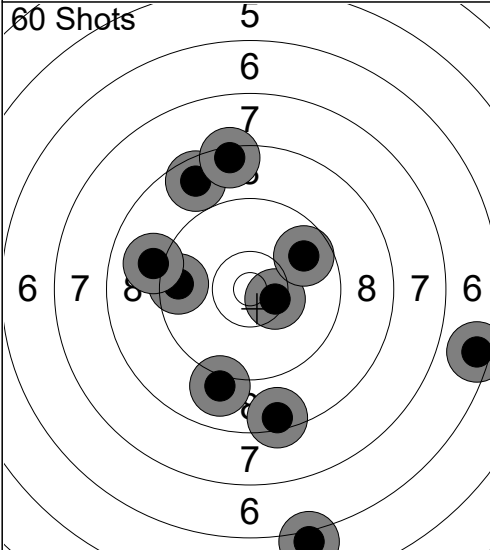
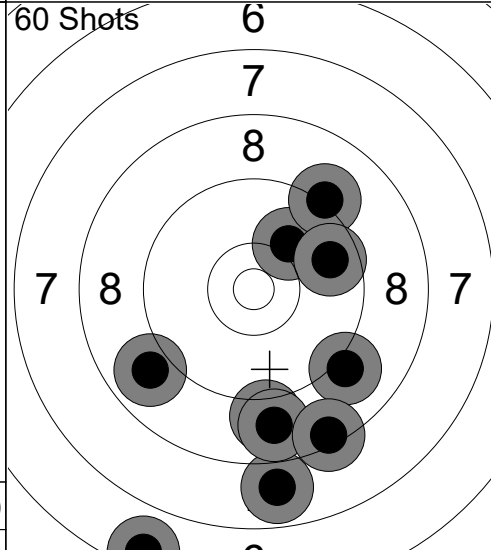
<p>60 Shots</p> 	<p>21: 8.7 ↑ 22: 10.4x → 23: 8.4 ↑ 24: 6.5 → 25: 9.8 → 26: 9.6 ← 27: 6.0 ↓ 28: 8.5 ↓ 29: 9.0 ← 30: 9.0 ↓</p> <p>Series 82 (1x) 237 (2x)</p>	<p>60 Shots</p> 	<p>31: 6.5 ↓ 32: 9.0 ↓ 33: 10.1 ↗ 34: 9.2 ↗ 35: 7.9 ↓ 36: 8.8 ↓ 37: 9.7 → 38: 9.1 ↓ 39: 8.9 ↖ 40: 8.4 ↓</p> <p>Series 83 (0x) 320 (2x)</p>
---	---	---	--

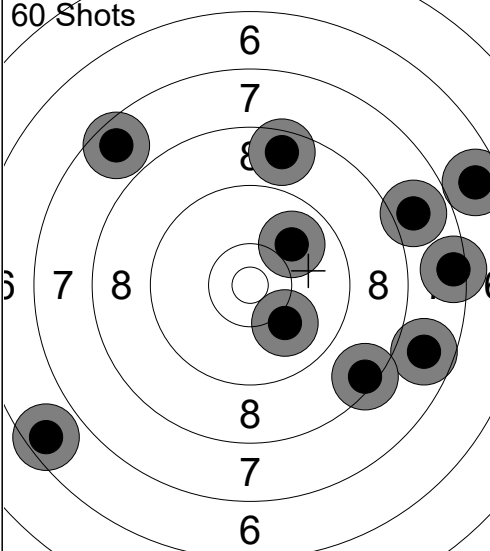
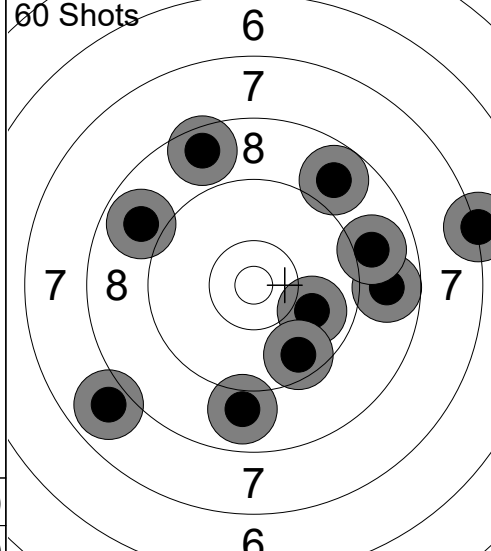
<p>60 Shots</p> 	<p>41: 6.6 ← 42: 6.7 → 43: 10.1 ↓ 44: 7.4 → 45: 7.7 → 46: 7.6 ↗ 47: 8.6 ↑ 48: 7.9 → 49: 8.4 ↓ 50: 9.9 ↗</p> <p>Series 75 (0x) 395 (2x)</p>	<p>60 Shots</p> 	<p>51: 9.9 → 52: 7.9 ↖ 53: 9.6 ↓ 54: 8.6 ↑ 55: 8.9 ↖ 56: 8.8 ↗ 57: 8.9 ↓ 58: 8.8 → 59: 9.0 → 60: 7.2 →</p> <p>Series 81 (0x) 476 (2x)</p>
--	--	--	---

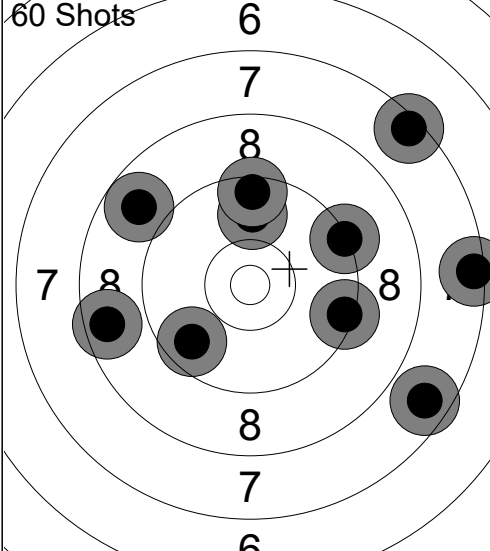
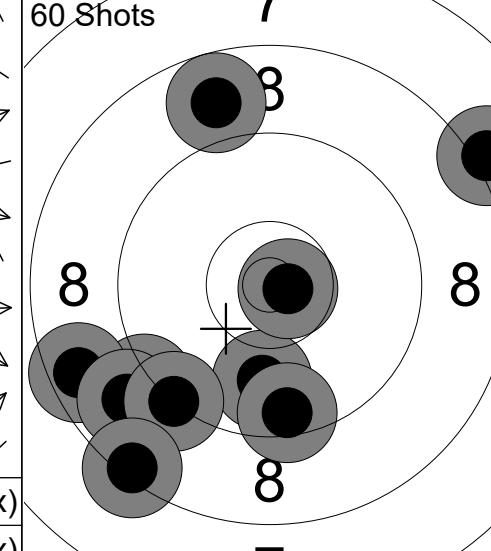
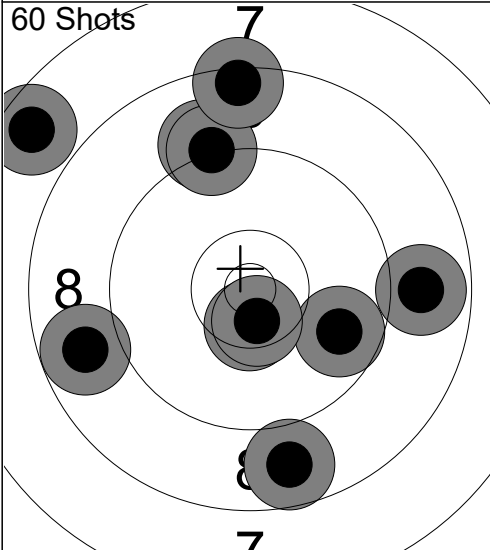
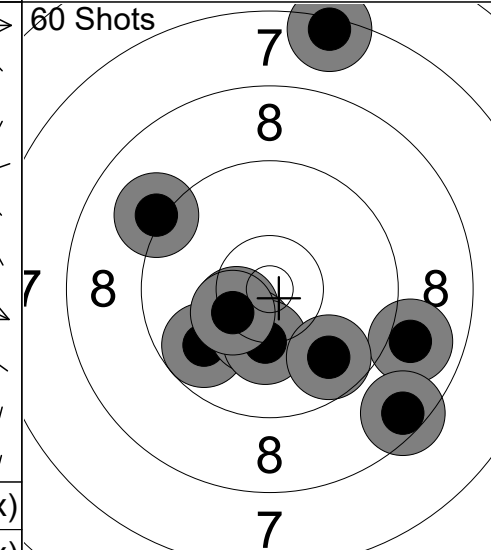
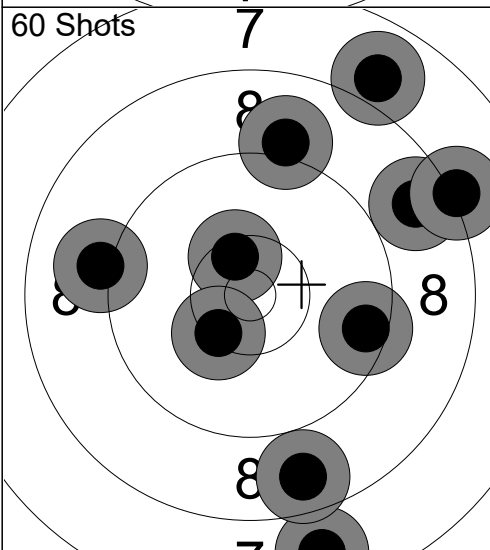
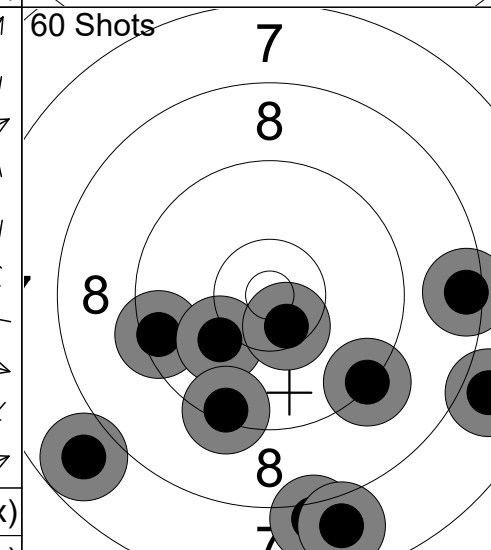
<p>60 Shots</p>  <p style="text-align: center;">6 7 8 7 8 7</p>	<p>1: 9.8 ↑ 2: 8.8 ↖ 3: 9.3 → 4: 8.6 ← 5: 9.4 ⇒ 6: 9.5 ↑ 7: 7.4 → 8: 7.6 ⇒ 9: 7.4 ↗ 10: 9.7 ↙</p> <p>Series 82 (0x) 82 (0x)</p>	<p>60 Shots</p>  <p style="text-align: center;">7 8 8 8</p> <p>11: 9.1 ↙ 12: 8.1 ↗ 13: 8.8 ↑ 14: 9.9 ↓ 15: 10.7x ⇒ 16: 8.6 ← 17: 9.5 ↓ 18: 8.9 ↙ 19: 9.2 ↙ 20: 8.4 ↙</p> <p>Series 86 (1x) 168 (1x)</p>
<p>60 Shots</p>  <p style="text-align: center;">6 7 8 7</p>	<p>21: 8.9 → 22: 9.1 ↑ 23: 10.5x ↓ 24: 8.8 ← 25: 9.2 ↑ 26: 8.4 ↑ 27: 9.7 ⇒ 28: 7.6 ↗ 29: 8.7 ↓ 30: 10.5x ↓</p> <p>Series 86 (2x) 254 (3x)</p>	<p>60 Shots</p>  <p style="text-align: center;">7 8 8 7</p> <p>31: 8.9 ⇒ 32: 9.1 ↖ 33: 9.8 ↙ 34: 10.4x ↙ 35: 10.3 ↓ 36: 10.2 ↓ 37: 7.4 ↑ 38: 9.8 ↘ 39: 8.5 ↘ 40: 10.4x ↙</p> <p>Series 90 (2x) 344 (5x)</p>
<p>60 Shots</p>  <p style="text-align: center;">7 8 8 7</p>	<p>41: 7.9 ↗ 42: 7.7 ↓ 43: 8.7 ↗ 44: 9.1 ↑ 45: 8.7 ↓ 46: 10.5x ↗ 47: 9.1 ← 48: 9.5 ⇒ 49: 10.4 ↙ 50: 8.2 ⇒</p> <p>Series 85 (1x) 429 (6x)</p>	<p>60 Shots</p>  <p style="text-align: center;">7 8 8 7</p> <p>51: 9.4 ← 52: 7.9 ⇒ 53: 10.1 ↙ 54: 7.8 ↙ 55: 8.0 ↓ 56: 9.4 ↓ 57: 10.5x ↓ 58: 9.3 ↘ 59: 7.9 ↓ 60: 8.4 ⇒</p> <p>Series 84 (1x) 513 (7x)</p>

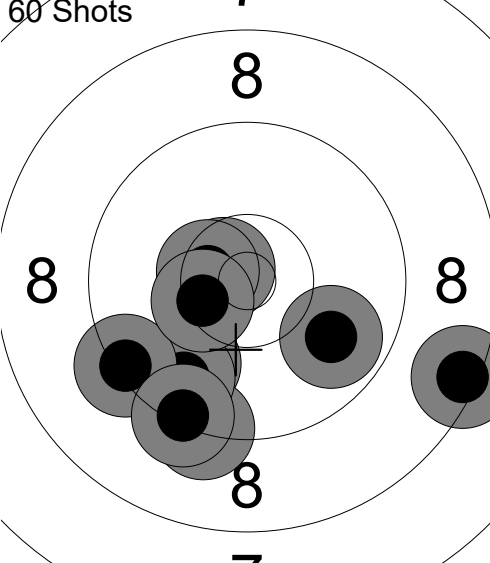
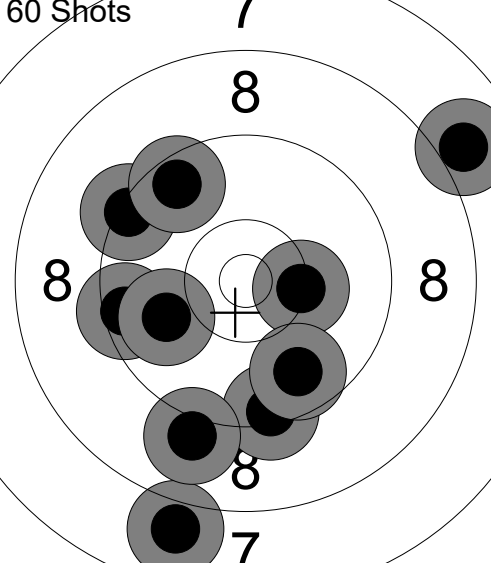
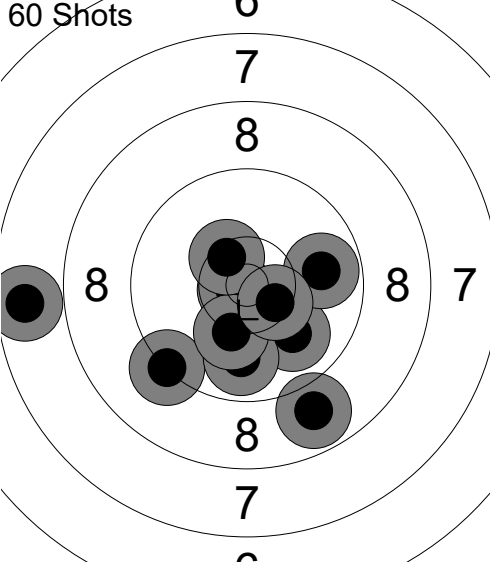
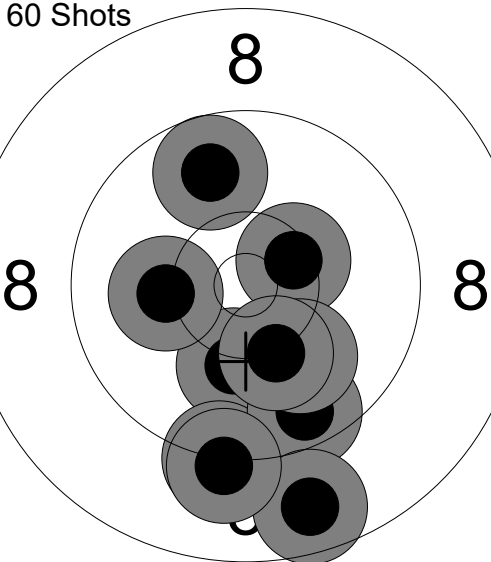
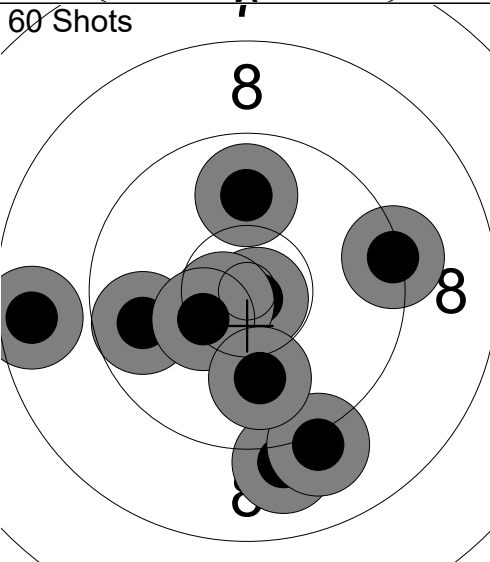
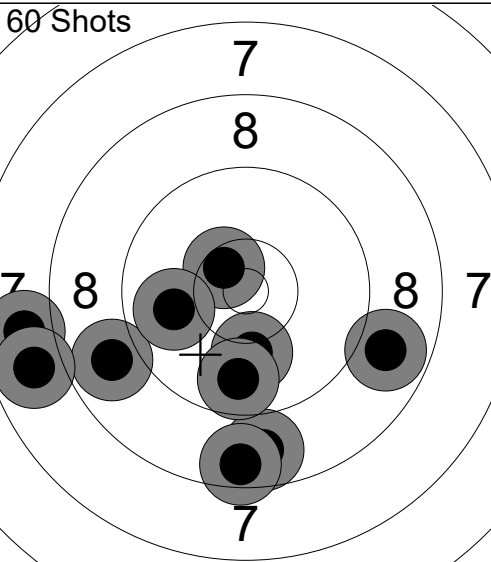
<p>60 Shots</p> 	<p>60 Shots</p> 	
<p>60 Shots</p> 	<p>60 Shots</p> 	
<p>60 Shots</p> 	<p>60 Shots</p> 	

Relay **5** Lane **79** **LAVE Leah**

1-80 NTCSC Altius Pistol

31.01.2025 2025 AirNats by X Count Civilian Marksmanship Program

Comment Signature

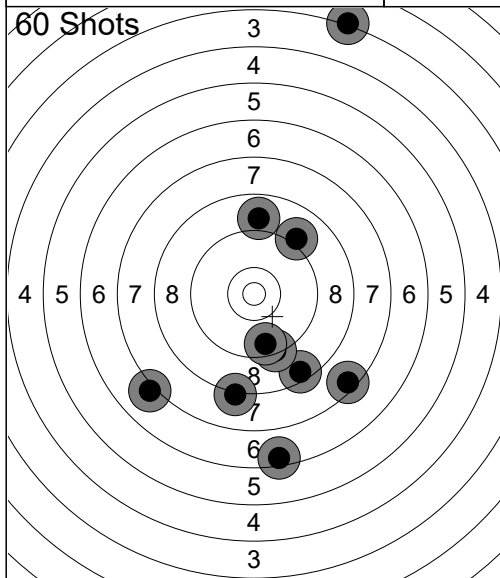

1:	8.9	↑
2:	3.2	↗
3:	8.5	↘
4:	9.3	↘
5:	8.2	↘
6:	9.6	↘
7:	7.5	↘
8:	6.4	↘
9:	9.1	↗
10:	7.1	↙
Series	74 (0x)	
	74 (0x)	

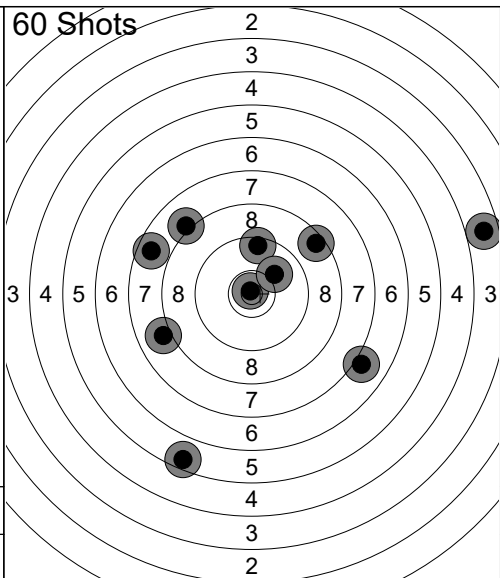

11:	10.8x	↗
12:	7.6	↖
13:	5.5	↘
14:	8.0	↖
15:	3.7	→
16:	8.5	↗
17:	9.5	↑
18:	8.1	↖
19:	7.0	→
20:	10.0	↗
Series	75 (1x)	
	149 (1x)	

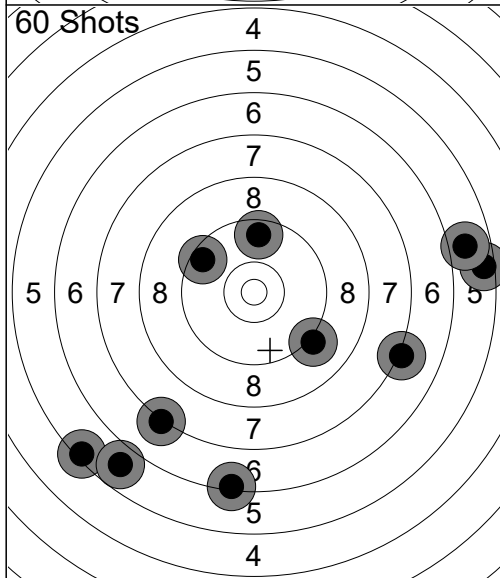

21:	6.3	↘
22:	9.6	↑
23:	7.2	→
24:	5.5	→
25:	5.4	↙
26:	9.1	↘
27:	5.8	→
28:	7.2	↙
29:	5.8	↙
30:	9.5	↖
Series	67 (0x)	
	216 (1x)	

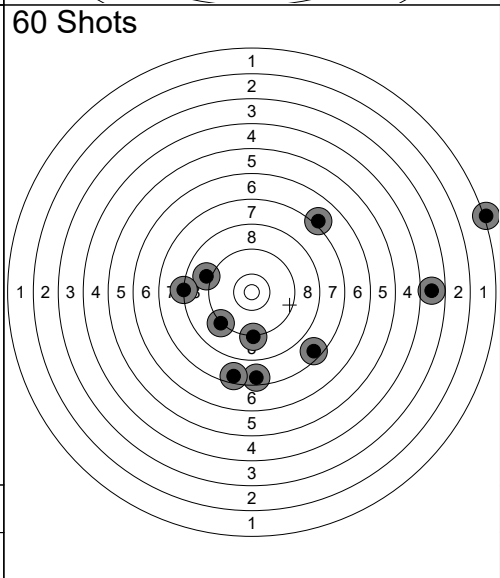

31:	7.5	↘
32:	9.0	↖
33:	9.2	↘
34:	7.1	↗
35:	3.8	→
36:	7.6	↘
37:	1.1	→
38:	8.2	←
39:	7.5	↘
40:	9.2	↙
Series	67 (0x)	
	283 (1x)	

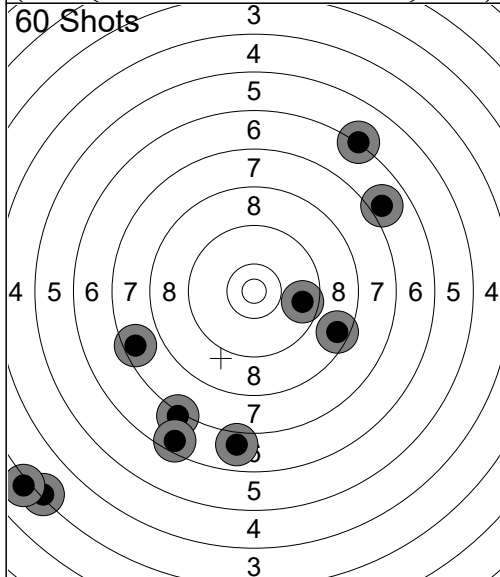

41:	3.3	↙
42:	6.9	↗
43:	7.5	↖
44:	3.1	↖
45:	8.5	→
46:	6.9	↘
47:	7.1	↘
48:	6.5	↘
49:	6.2	↗
50:	9.7	→
Series	61 (0x)	
	344 (1x)	

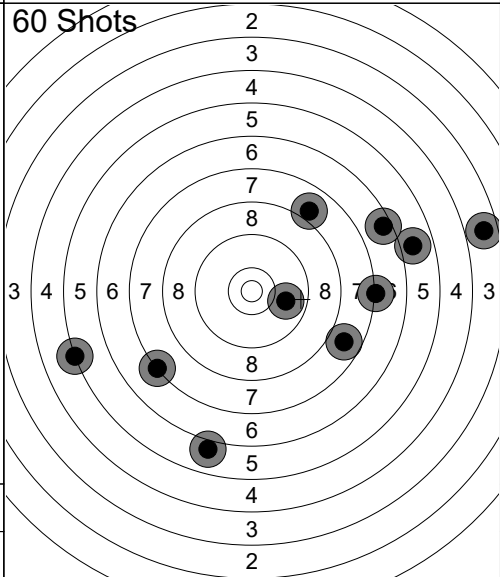

51:	7.8	→
52:	6.0	↘
53:	5.9	→
54:	7.2	↖
55:	3.7	→
56:	8.0	↗
57:	6.5	↗
58:	7.2	→
59:	9.9	→
60:	5.2	←
Series	63 (0x)	
	407 (1x)	